

35 015

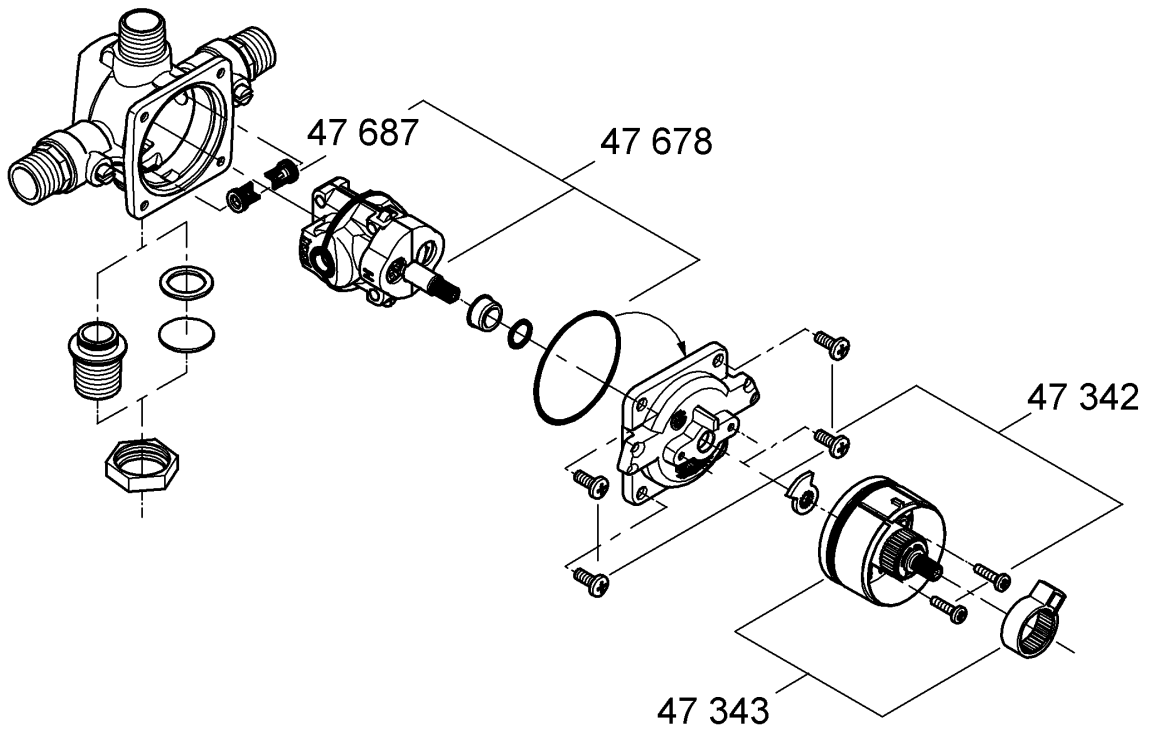

19 899

