

  
**BRADFORD WHITE**<sup>®</sup>  
W A T E R   H E A T E R S

**COMMERCIAL REPLACEMENT PARTS LIST**  
**Electric Energy Saver ASME Series**



50A SHOWN

Includes Hydrojet<sup>®</sup>  
Total Performance System







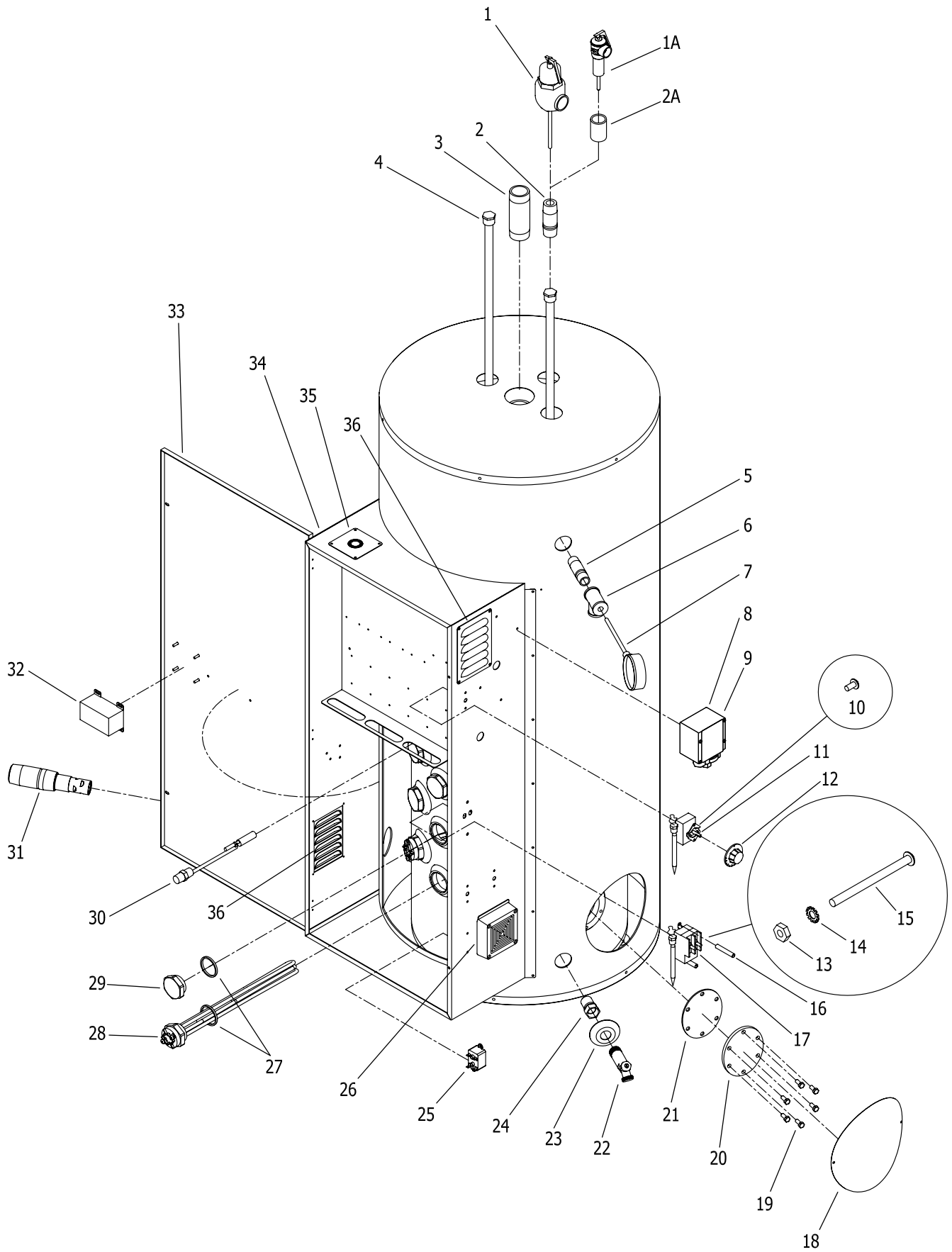



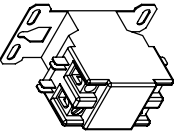
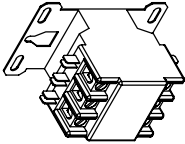
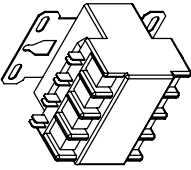



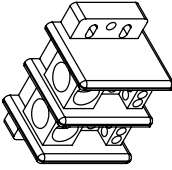
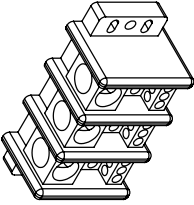
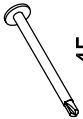

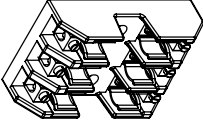
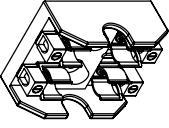
***Effective: June 1, 2009***

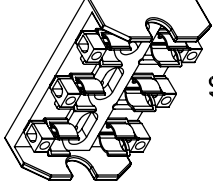
**NOTE: BOTH MODEL AND SERIAL  
NUMBERS ARE REQUIRED FOR  
ORDERING REPLACEMENT PARTS**

Dimensions and specifications  
subject to change without notice.





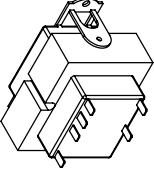
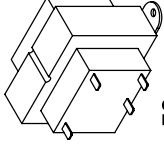
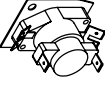



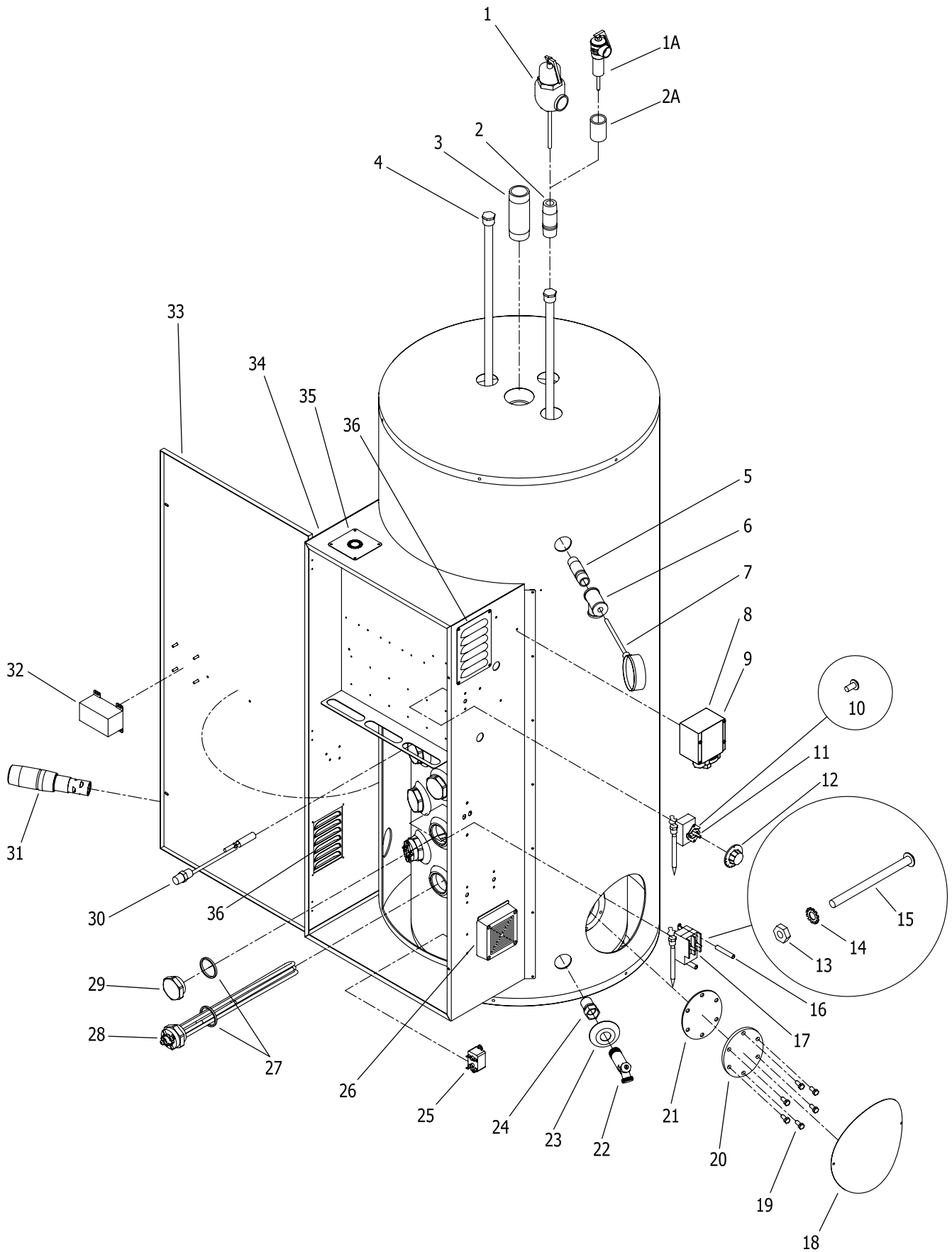



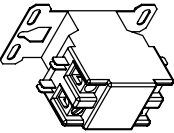
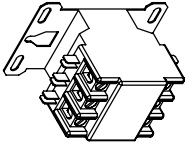
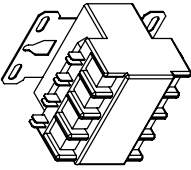



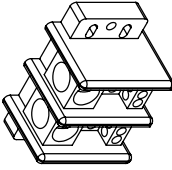
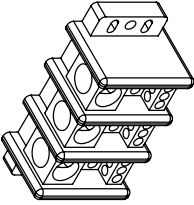
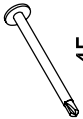

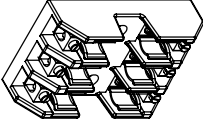
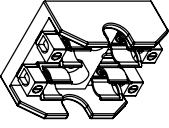
Item	Description	Model 6A-KW-3	Model 12A-KW-3	Model 20A-KW-3	Model 30A-KW-3
1	T&P Relief Valve (Female Threads)	---	---	---	---
1A	T&P Relief Valve (Male Threads)	230-32920-04 (3/4"NPT)	230-32920-04 (3/4"NPT)	230-32920-04 (3/4"NPT)	230-30246-00 (3/4"NPT)
2	Nipple-Plastisert	---	---	---	229-32762-03
2A	Coupling	239-46679-00	239-46679-00	239-46679-00	---
3	Hot Water Outlet Nipple-Plastisert	229-32762-03	229-32762-03	229-32762-03	229-32762-03
4	Magnesium Anode Rod	224-32758-32	224-32758-32	224-32758-33	224-32758-34
	Aluminum Anode Rod	224-38508-08	224-38508-08	224-38508-02	224-38508-04
5	Nipple-3/4 NPT X 1-3/8 Galvanized	239-81075-00	239-81075-00	239-81075-00	---
	Nipple-3/4 NPT X 3-1/2 Plastisert	---	---	---	---
6	Galvanized Tee-3/4 X 1/2 X 1/2 NPT	239-41925-00	239-41925-00	239-41925-00	239-41925-00
7	Combination T&P Gage (Optional)	264-41987-00	264-41987-00	264-41987-00	264-41987-00
8	Pressure Switch (High) (Optional)	264-42004-01	264-42004-01	264-42004-01	264-42004-01
9	Pressure Switch (Low) (Optional)	264-42004-02	264-42004-02	264-42004-02	264-42004-02
10	Screw-#6-32 X 1/4	264-81722-00 (Qty. 2)	264-81722-00 (Qty. 2)	264-81722-00 (Qty. 2)	264-81722-00 (Qty. 2)
11	Immersion Thermostat	264-33460-00	264-33460-00	264-33460-00	264-33460-00
12	Thermostat Dial	264-33459-00	264-33459-00	264-33459-00	264-33459-00
13	Hex Nut-#10-32	239-34049-00 (Qty. 2)	239-34049-00 (Qty. 2)	239-34049-00 (Qty. 2)	239-34049-00 (Qty. 2)
14	External Tooth Washer #10	239-81540-00 (Qty. 2)	239-81540-00 (Qty. 2)	239-81540-00 (Qty. 2)	239-81540-00 (Qty. 2)
15	Screw-#10-32 X 2 1/2	239-34048-00 (Qty. 2)	239-34048-00 (Qty. 2)	239-34048-00 (Qty. 2)	239-34048-00 (Qty. 2)
16	High Limit Spacer	264-34190-00 (Qty. 2)	264-34190-00 (Qty. 2)	264-34190-00 (Qty. 2)	264-34190-00 (Qty. 2)
17	High Limit Switch	264-33461-00	264-33461-00	264-33461-00	264-33461-00
18	Cleanout Cover (Jacket)	---	---	243-42497-00	243-42497-00
19	Cleanout Screw-5/16-18 X 3/4	---	---	239-32970-00 (Qty. 6)	239-32970-00 (Qty. 6)
20	Cleanout Cover (Tank)	---	---	205-32941-00	205-32941-00
21	Cleanout Gasket	---	---	205-32942-00	205-32942-00
22	Brass Drain Valve	265-42351-04	265-42351-04	265-42351-04	265-42351-04
23	Finished Flange-2 7/8 O.D.	---	---	---	---
24	Extender-3/4 X 2	---	---	---	---
25	Alarm Horn Relay (Optional)	264-42002-00	264-42002-00	264-42002-00	264-42002-00
26	Alarm Horn (Optional)	264-42001-00	264-42001-00	264-42001-00	264-42001-00
27	Heating Element Gasket	223-42016-00	223-42016-00	223-42016-00	223-42016-00
28	Heating Element	See Element Table	See Element Table	See Element Table	See Element Table
29	Heating Element Plug	223-42015-00	223-42015-00	223-42015-00	223-42015-00
30	Low Water Switch (Optional)	264-42000-00	264-42000-00	264-42000-00	264-42000-00
31	Cold Water Inlet Nipple	229-45268-00	229-45268-00	229-45268-00	229-45268-00
32	Electrical Door Lock (Optional)	264-42003-00	264-42003-00	264-42003-00	264-42003-00
33	Control Box Door	239-41944-00	239-41945-00	239-41946-00	239-41947-00

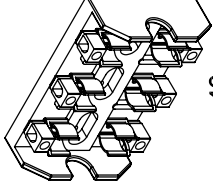
<p><b>CONTACTORS</b></p>  <p>37</p>  <p>38</p>  <p>39</p>  <p>40</p>	<p><b>TERMINAL BLOCKS</b></p>  <p>41</p>  <p>42</p>  <p>43</p>  <p>44</p>  <p>45</p>	<p><b>FUSE BLOCKS</b></p>  <p>46</p>  <p>47</p>  <p>48</p>  <p>45</p>  <p>49</p>	<p><b>TERMINAL STRIPS</b></p>  <p>50</p>  <p>51</p>	<p><b>FUSES</b></p>  <p>52</p>  <p>53</p> <p><b>GROUND LUGS</b></p>  <p>54</p>  <p>55</p>  <p>56</p>	<p><b>TRANSFORMERS</b></p>  <p>57</p>  <p>58</p>	<p><b>SEQUENCERS</b></p>  <p>59</p>
--	---	---	---	---	---	--

Item	Description	Model 6A-KW-3	Model 12A-KW-3	Model 20A-KW-3	Model 30A-KW-3
34	Control Box	239-42669-00	239-42660-00	239-42661-00	239-42663-00
35	Knockout Plate (Small)	243-41966-00-01	243-41966-00-01	243-41966-00-01	243-41966-00-01
	Knockout Plate (Large)	243-41967-00-01	243-41967-00-01	243-41967-00-01	243-41967-00-01
36	Louver Plate	243-41963-00-01	243-41963-00-01	243-41963-00-01	243-41963-00-01
37	Contactor 2 Pole (35A)	264-41986-01	264-41986-01	264-41986-01	264-41986-01
	Contactor 2 Pole (50A)	264-41986-02	264-41986-02	264-41986-02	264-41986-02
38	Contactor 3 Pole (35A)	264-41988-01	264-41988-01	264-41988-01	264-41988-01
	Contactor 3 Pole (50A)	264-41988-02	264-41988-02	264-41988-02	264-41988-02
39	Contactor 4 Pole (35A)	264-41989-01	264-41989-01	264-41989-01	264-41989-01
	Contactor 4 Pole (50A)	264-41989-02	264-41989-02	264-41989-02	264-41989-02
40	Screw-#8-18 X 1/2	239-32761-00	239-32761-00	239-32761-00	239-32761-00
41	Terminal Block (Block A)	264-32240-00	264-32240-00	264-32240-00	264-32240-00
42	Terminal Block End (Use for Block A)	264-32241-00	264-32241-00	264-32241-00	264-32241-00
43	Terminal Block (2 Pole)	264-32244-00	264-32244-00	264-32244-00	264-32244-00
44	Terminal Block (3 Pole)	264-32245-00	264-32245-00	264-32245-00	264-32245-00
45	Screw-#8-18 X 1 1/2	264-34197-00	264-34197-00	264-34197-00	264-34197-00
46	Fuse Block 2 Pole G Class (60A, 480V)	264-32263-00	264-32263-00	264-32263-00	264-32263-00
47	Fuse Block 3 Pole G Class (60A, 480V)	264-32264-00	264-32264-00	264-32264-00	264-32264-00
48	Fuse Block 2 Pole T Class (30A, 600V)	264-41974-01	264-41974-01	264-41974-01	264-41974-01
	Fuse Block 2 Pole T Class (60A, 600V)	264-41974-02	264-41974-02	264-41974-02	264-41974-02
49	Fuse Block 3 Pole T Class (60A, 600V)	264-41975-00	264-41975-00	264-41975-00	264-41975-00
	Fuse Block 3 Pole T Class (30A, 600V)	264-42568-00	264-42568-00	264-42568-00	264-42568-00
50	Terminal Strip (5 Post)	264-42006-00	264-42006-00	264-42006-00	264-42006-00
51	Terminal Strip (2 Post)	264-42007-00	264-42007-00	264-42007-00	264-42007-00
52	Fuse G Class (40A)	264-32267-00	264-32267-00	264-32267-00	264-32267-00
	Fuse G Class (50A)	264-32268-00	264-32268-00	264-32268-00	264-32268-00
	Fuse G Class (60A)	264-32269-00	264-32269-00	264-32269-00	264-32269-00
53	Fuse T Class (30A)	264-41976-01	264-41976-01	264-41976-01	264-41976-01
	Fuse T Class (40A)	264-41976-02	264-41976-02	264-41976-02	264-41976-02
	Fuse T Class (50A)	264-41976-03	264-41976-03	264-41976-03	264-41976-03
54	Ground Lug Large (Wire Range 8-1/0)	264-32250-00	264-32250-00	264-32250-00	264-32250-00
55	Ground Lug Small (Wire Range 14-8)	264-32251-00	264-32251-00	264-32251-00	264-32251-00
56	Screw-#10-32 X 1/2	239-33938-00	239-33938-00	239-33938-00	239-33938-00
57	Control Circuit Transformer 60Va (208/240/480 VAC)	264-41994-01	264-41994-01	264-41994-01	264-41994-01
	Control Circuit Transformer 60Va (277/380/415 VAC)	264-41994-02	264-41994-02	264-41994-02	264-41994-02
58	Control Circuit Transformer 60Va (600 VAC)	264-41996-00	264-41996-00	264-41996-00	264-41996-00
59	Time Delay Sequencer	264-41997-00	264-41997-00	264-41997-00	264-41997-00

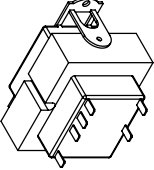
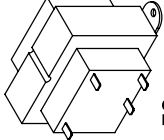
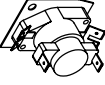

Item	Description	Model 40A-KW-3	Model 50A-KW-3	Model 80A-KW-3	Model 120A-KW-3
1	T&P Relief Valve (Female Threads)	230-30246-00 (3/4" NPT)	230-33630-04 (1" NPT)	230-33630-04 (1" NPT)	230-33630-04 (1" NPT)
1A	T&P Relief Valve (Male Threads)	---	---	---	---
2	Nipple-Plastisert	229-32762-03	229-32762-21	229-32762-20	229-32762-21
2A	Coupling	---	---	---	---
3	Hot Water Outlet Nipple-Plastisert	229-32762-03	229-40913-06	229-40913-06	229-40913-06
4	Magnesium Anode Rod	224-32758-19	224-32758-15 (Qty. 2)	224-32758-14 (Qty. 2)	224-32758-14 (Qty. 2)
	Aluminum Anode Rod	224-38508-03	224-38508-03 (Qty. 2)	224-38508-07 (Qty. 2)	224-38508-07 (Qty. 2)
5	Nipple-3/4 NPT X 1-3/8 Galvanized	---	---	---	---
	Nipple-3/4 NPT X 3-1/2 Plastisert	---	229-32762-08	229-32762-08	229-32762-08
6	Galvanized Tee-3/4 X 1/2 X 1/2 NPT	239-41925-00	239-41925-00	239-41925-00	239-41925-00
7	Combination T&P Gage (Optional)	264-41987-00	264-41987-00	264-41987-00	264-41987-00
8	Pressure Switch (High) (Optional)	264-42004-01	264-42004-01	264-42004-01	264-42004-01
9	Pressure Switch (Low) (Optional)	264-42004-02	264-42004-02	264-42004-02	264-42004-02
10	Screw-#6-32 X 1/4	264-81722-00 (Qty. 2)	264-81722-00 (Qty. 2)	264-81722-00 (Qty. 2)	264-81722-00 (Qty. 2)
11	Immersion Thermostat	264-33460-00	264-33460-00	264-33460-00	264-33460-00
12	Thermostat Dial	264-33459-00	264-33459-00	264-33459-00	264-33459-00
13	Hex Nut-#10-32	239-34049-00 (Qty. 2)	239-34049-00 (Qty. 2)	239-34049-00 (Qty. 2)	239-34049-00 (Qty. 2)
14	External Tooth Washer #10	239-81540-00 (Qty. 2)	239-81540-00 (Qty. 2)	239-81540-00 (Qty. 2)	239-81540-00 (Qty. 2)
15	Screw-#10-32 X 2 1/2	239-34048-00 (Qty. 2)	239-34048-00 (Qty. 2)	239-34048-00 (Qty. 2)	239-34048-00 (Qty. 2)
16	High Limit Spacer	264-34190-00 (Qty. 2)	264-34190-00 (Qty. 2)	264-34190-00 (Qty. 2)	264-34190-00 (Qty. 2)
17	High Limit Switch	264-33461-00	264-33461-00	264-33461-00	264-33461-00
18	Cleanout Cover (Jacket)	243-42497-00	243-20299-00	243-20299-00	243-20299-00
19	Cleanout Screw-5/16-18 X 3/4	239-32970-00 (Qty. 6)	239-32970-00 (Qty. 6)	239-32970-00 (Qty. 6)	239-32970-00 (Qty. 6)
20	Cleanout Cover (Tank)	205-32941-00	205-32941-00	205-32941-00	205-32941-00
21	Cleanout Gasket	205-32942-00	205-32942-00	205-32942-00	205-32942-00
22	Brass Drain Valve	265-42351-04	265-42351-04	265-42351-04	265-42351-04
23	Finished Flange-2 7/8 O.D.	---	239-41414-00	239-41414-00	239-41414-00
24	Extender-3/4 X 2	---	229-19100-00	229-19100-00	229-19100-00
25	Alarm Horn Relay (Optional)	264-42002-00	264-42002-00	264-42002-00	264-42002-00
26	Alarm Horn (Optional)	264-42001-00	264-42001-00	264-42001-00	264-42001-00
27	Heating Element Gasket	223-42016-00	223-42016-00	223-42016-00	223-42016-00
28	Heating Element	See Element Table	See Element Table	See Element Table	See Element Table
29	Heating Element Plug	223-42015-00	223-42015-00	223-42015-00	223-42015-00
30	Low Water Switch (Optional)	264-42000-00	264-42000-00	264-42000-00	264-42000-00
31	Cold Water Inlet Nipple	229-45268-00	229-44731-00	229-44731-00	229-44731-00
32	Electrical Door Lock (Optional)	264-42003-00	264-42003-00	264-42003-00	264-42003-00
33	Control Box Door	239-41947-00	239-42105-00	239-42105-00	239-42105-00

<p><b>CONTACTORS</b></p>  <p>37</p>  <p>38</p>  <p>39</p>  <p>40</p>	<p><b>TERMINAL BLOCKS</b></p>  <p>41</p>  <p>42</p>  <p>43</p>  <p>44</p>  <p>45</p>	<p><b>FUSE BLOCKS</b></p>  <p>46</p>  <p>47</p>  <p>48</p>  <p>45</p>  <p>49</p>	<p><b>TERMINAL STRIPS</b></p>  <p>50</p>  <p>51</p>	<p><b>FUSES</b></p>  <p>52</p>  <p>53</p> <p><b>GROUND LUGS</b></p>  <p>54</p>  <p>55</p>  <p>56</p>	<p><b>TRANSFORMERS</b></p>  <p>57</p>  <p>58</p>	<p><b>SEQUENCERS</b></p>  <p>59</p>
--	---	---	---	---	---	--



Item	Description	Model 40A-KW-3	Model 50A-KW-3	Model 80A-KW-3	Model 120A-KW-3
34	Control Box	239-42663-00	239-42106-00	239-42107-00	239-42108-00
35	Knockout Plate (Small)	243-41966-00-01	243-41966-00-01	243-41966-00-01	243-41966-00-01
	Knockout Plate (Large)	243-41967-00-01	243-41967-00-01	243-41967-00-01	243-41967-00-01
36	Louver Plate	243-41963-00-01	243-41963-00-01	243-41963-00-01	243-41963-00-01
37	Contactor 2 Pole (35A)	264-41986-01	264-41986-01	264-41986-01	264-41986-01
	Contactor 2 Pole (50A)	264-41986-02	264-41986-02	264-41986-02	264-41986-02
38	Contactor 3 Pole (35A)	264-41988-01	264-41988-01	264-41988-01	264-41988-01
	Contactor 3 Pole (50A)	264-41988-02	264-41988-02	264-41988-02	264-41988-02
39	Contactor 4 Pole (35A)	264-41989-01	264-41989-01	264-41989-01	264-41989-01
	Contactor 4 Pole (50A)	264-41989-02	264-41989-02	264-41989-02	264-41989-02
40	Screw-#8-18 X 1/2	239-32761-00	239-32761-00	239-32761-00	239-32761-00
41	Terminal Block (Block A)	264-32240-00	264-32240-00	264-32240-00	264-32240-00
42	Terminal Block End (Use for Block A)	264-32241-00	264-32241-00	264-32241-00	264-32241-00
43	Terminal Block (2 Pole)	264-32244-00	264-32244-00	264-32244-00	264-32244-00
44	Terminal Block (3 Pole)	264-32245-00	264-32245-00	264-32245-00	264-32245-00
45	Screw-#8-18 X 1 1/2	264-34197-00	264-34197-00	264-34197-00	264-34197-00
46	Fuse Block 2 Pole G Class (60A, 480V)	264-32263-00	264-32263-00	264-32263-00	264-32263-00
47	Fuse Block 3 Pole G Class (60A, 480V)	264-32264-00	264-32264-00	264-32264-00	264-32264-00
48	Fuse Block 2 Pole T Class (30A, 600V)	264-41974-01	264-41974-01	264-41974-01	264-41974-01
	Fuse Block 2 Pole T Class (60A, 600V)	264-41974-02	264-41974-02	264-41974-02	264-41974-02
49	Fuse Block 3 Pole T Class (60A, 600V)	264-41975-00	264-41975-00	264-41975-00	264-41975-00
	Fuse Block 3 Pole T Class (30A, 600V)	264-42568-00	264-42568-00	264-42568-00	264-42568-00
50	Terminal Strip (5 Post)	264-42006-00	264-42006-00	264-42006-00	264-42006-00
51	Terminal Strip (2 Post)	264-42007-00	264-42007-00	264-42007-00	264-42007-00
52	Fuse G Class (40A)	264-32267-00	264-32267-00	264-32267-00	264-32267-00
	Fuse G Class (50A)	264-32268-00	264-32268-00	264-32268-00	264-32268-00
	Fuse G Class (60A)	264-32269-00	264-32269-00	264-32269-00	264-32269-00
53	Fuse T Class (30A)	264-41976-01	264-41976-01	264-41976-01	264-41976-01
	Fuse T Class (40A)	264-41976-02	264-41976-02	264-41976-02	264-41976-02
	Fuse T Class (50A)	264-41976-03	264-41976-03	264-41976-03	264-41976-03
54	Ground Lug Large (Wire Range 8-1/0)	264-32250-00	264-32250-00	264-32250-00	264-32250-00
55	Ground Lug Small (Wire Range 14-8)	264-32251-00	264-32251-00	264-32251-00	264-32251-00
56	Screw-#10-32 X 1/2	239-33938-00	239-33938-00	239-33938-00	239-33938-00
57	Control Circuit Transformer 60Va (208/240/480 VAC)	264-41994-01	264-41994-01	264-41994-01	264-41994-01
	Control Circuit Transformer 60Va (277/380/415 VAC)	264-41994-02	264-41994-02	264-41994-02	264-41994-02
58	Control Circuit Transformer 60Va (600 VAC)	264-41996-00	264-41996-00	264-41996-00	264-41996-00
59	Time Delay Sequencer	264-41997-00	264-41997-00	264-41997-00	264-41997-00

Heating Elements (Incoloy) for:  
Commercial "A" ASME Series

Wattage	208 Volt	240 Volt	277 Volt	380Volt
1000W▲	---	---	---	---
2000W▲	220-41985-01	220-41985-08	220-41985-15	220-41985-43
3000W▲▲	220-41985-02	220-41985-09	220-41985-16	220-41985-44
4000W*	220-41985-03	220-41985-10	220-41985-17	220-41985-45
4500W*	220-41985-13	220-41985-11	220-41985-18	220-41985-46
5000W*	220-41985-05	220-41985-12	220-41985-19	220-41985-47
6000W*	220-41985-06	220-41985-13	220-41985-20	220-41985-57
9000W**	220-41985-51	220-41985-52	220-41985-53	220-41985-50

Wattage	400 Volt	415 Volt	480 Volt	600 Volt
1000W▲	220-41985-58	---	---	---
2000W▲	220-41985-59	220-41985-22	220-41985-29	220-41985-36
3000W▲▲	220-41985-60	220-41985-23	220-41985-30	220-41985-37
4000W*	220-41985-61	220-41985-24	220-41985-31	220-41985-38
4500W*	220-41985-62	220-41985-25	220-41985-32	220-41985-39
5000W*	---	220-41985-26	220-41985-33	220-41985-40
6000W*	---	220-41985-27	220-41985-34	220-41985-41
9000W**	---	220-41985-54	220-41985-55	220-41985-56

- ▲ For 12" diameter tanks and above.
- ▲▲ For 14" diameter tanks and above.
- \* For 16" diameter tanks and above.
- \*\* For 18" diameter tanks and above.





# **BRADFORD WHITE®**

W A T E R H E A T E R S

Ambler, PA

For U.S. and Canada field service,  
contact your professional installer or  
local Bradford White sales representative.

**Sales/800-523-2931**  
**Fax/215-641-1670**  
**Parts Fax/215-641-2180**

**Technical Support/800-334-3393**  
**Fax/269-795-1089**

**Warranty/800-531-2111**  
**Fax/269-795-1089**

**International:**  
**Telephone/215-641-9400**  
**Telefax/215-641-9750**



# **BRADFORD WHITE-CANADA® INC.**

Mississauga, ON

**Sales/866-690-0961**  
**905-238-0100**

**Fax/905-238-0105**

**Technical Support/800-334-3393**

**Email**

**parts@bradfordwhite.com**  
**techserv@bradfordwhite.com**

**www.bradfordwhite.com**