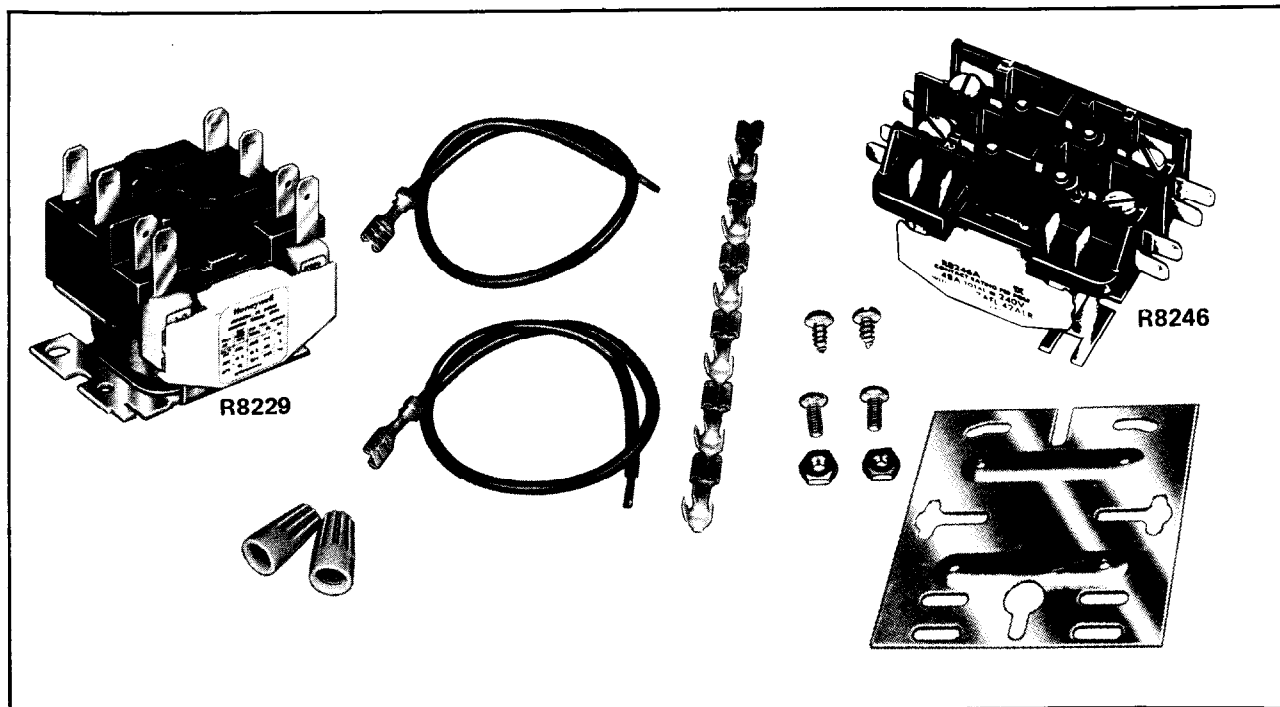

**R8229A ELECTRIC HEAT RELAY
R8246A ELECTRIC HEAT CONTACTOR**

THE R8229A AND R8246A ARE RECONTROL REPLACEMENTS FOR MOST SINGLE OR MULTIPLE ELEMENT ELECTRIC FURNACE SEQUENCERS AND CONTACTORS. COMBINATIONS OF RELAYS AND CONTACTORS CAN BE USED TO CONTROL UP TO 12 HEATING ELEMENTS.

THE RELAY OR CONTACTOR CAN BE USED ON FURNACES USING LINE VOLTAGE OR PILOT DUTY LIMITS IN 240V AC AND 120/240V AC ISOLATED FAN AND 240V AC COMBINATION RATED WIRING SYSTEMS.

- Quick-connect terminals for maximum wiring flexibility.
- Terminal clamp screws also included on R8246A contactor.
- Field proven, reliable operation.

- Quiet—designed for electric heat use.
- Simple ON-OFF switching—readily understood, easily serviced, and eliminates cold startup drafts.
- Thermostat current draw is constant (0.23 amp).
- Single unit control of up to 2 heating elements plus fan with R8229A, or 4 heating elements plus a fan with R8246A; reduces control space and simplifies wiring in furnace.
- Wiring accessories included to make installation quick and efficient.
- Mounts in any position. Mounting adapter plate supplied to simplify competitive device replacement.
- Meets or exceeds all industry standards.

FEATURES

The SUPER TRADELINE electric heat relay switches up to two 5 kW elements plus a fan, and the contactor switches up to four 5 kW heating elements plus a fan. Because the R8229A and R8246A are designed for electric heat, they will replace sequencers, relays, and contactors.

Everything you need is included. This SUPER TRADELINE package includes—

- universal mounting plate (to assure quick, easy replacement).
- two sheetmetal mounting screws.
- two nuts and bolts (for optional mounting).
- two 12 inch [304.8 mm] leadwires with quick-connects.
- two wire nuts.
- six female quick-connect terminals.
- special instructions.
- special cross reference label.

Extra parts that may not be necessary on an installation can still be useful as additions to your regular tool kit.

Replacing existing relays, contactors, and sequencers with the R8229A Electric Heat Relay or R8246A Electric Heat Contactor updates existing appliances to newer industry standards. Cold drafts are reduced because

there is no time delay between heating elements. Recontrol with the R8229A Electric Heat Relay or R8246A Electric Heat Contactor:

- Gives quiet conventional ON and OFF switching. Special design based on a line of Honeywell relays and contactors with years of reliable, trouble-free performance.
- The R8246A switches the maximum allowable NEC and Underwriters Laboratories Inc. circuit subdivision of 48 amperes. You can recontrol existing appliances with fewer controls. Saves you time and the homeowner money.
- Simplifies application, service, and checkout. One of the serviceman's major complaints is that sequencing circuitry is too complex. The R8229A and R8246A can be applied to any electric heat furnace using the basic idea of ON and OFF switching of the elements and fan.
- Provides easy installation. The small size of the R8229A and R8246A makes installation in today's compact wiring compartments easier. The universal mounting adapter plate and wiring accessories help assure that you have everything you need before you start.

APPLICATION

The R8229A relay and R8246A contactor provide recontrol replacements for most single or multiple element electric heat relays, contactors, and sequencers used in electric heating appliances. Each R8229A relay switches a fan and 1 or 2 heating elements. Each R8246A contactor switches a fan and up to 4 heating elements. Two or three relays and contactors can be used together to control from 4 to 12 heating elements. The R8229A and R8246A may be used with either line voltage or pilot duty limit applications.

MAXIMUM AMBIENT TEMPERATURE: 165 F [74 C].
TERMINALS:

R8229A—1/4 inch male quick-connect terminals.

R8246A—No. 10 terminal clamp screws and double male 1/4 inch quick-connects.

NOTE: Female quick-connects should be selected with care. The use of a premium grade quick-connect, such as the AMP Faston "250" series or equivalent is recommended.

DIMENSIONS: See Figs. 1 and 2.

MOUNTING MEANS: Two screws (up to No. 10 size) through holes in base. See Fig. 1.

UNDERWRITERS LABORATORIES INC. COMPONENT RECOGNIZED: File No. E59779, Guide No. NLDX2.

CANADIAN STANDARDS ASSOCIATION COMPONENT RECOGNITION: File No. LR1620.

COIL RATINGS:

Pickup Voltage (maximum) ^{a,b}	18V ac
Pickup Voltage (nominal) ^{a,b}	14V ac
Dropout Voltage (nominal)	6V ac
Maximum Inrush VA at Rated Voltage	6.2 VA
Nominal Inrush VA at Rated Voltage	5.5 VA
Sealed VA (maximum)	6.2 VA
Sealed VA (nominal)	5.5 VA
Sealed Amp (nominal)	.23 amp

^aVoltage listed is for the base mounted vertical.

^bInstantly applied voltage simulating thermostat operation.

CONTROL VOLTAGE: 24V ac, 0.23 amp.

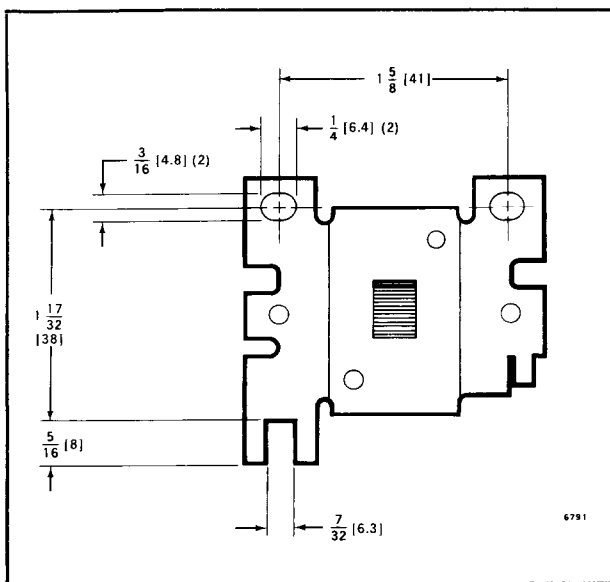

FIG. 1—DIMENSIONS OF RELAY AND CONTACTOR BASE, IN INCHES [MILLIMETRES].

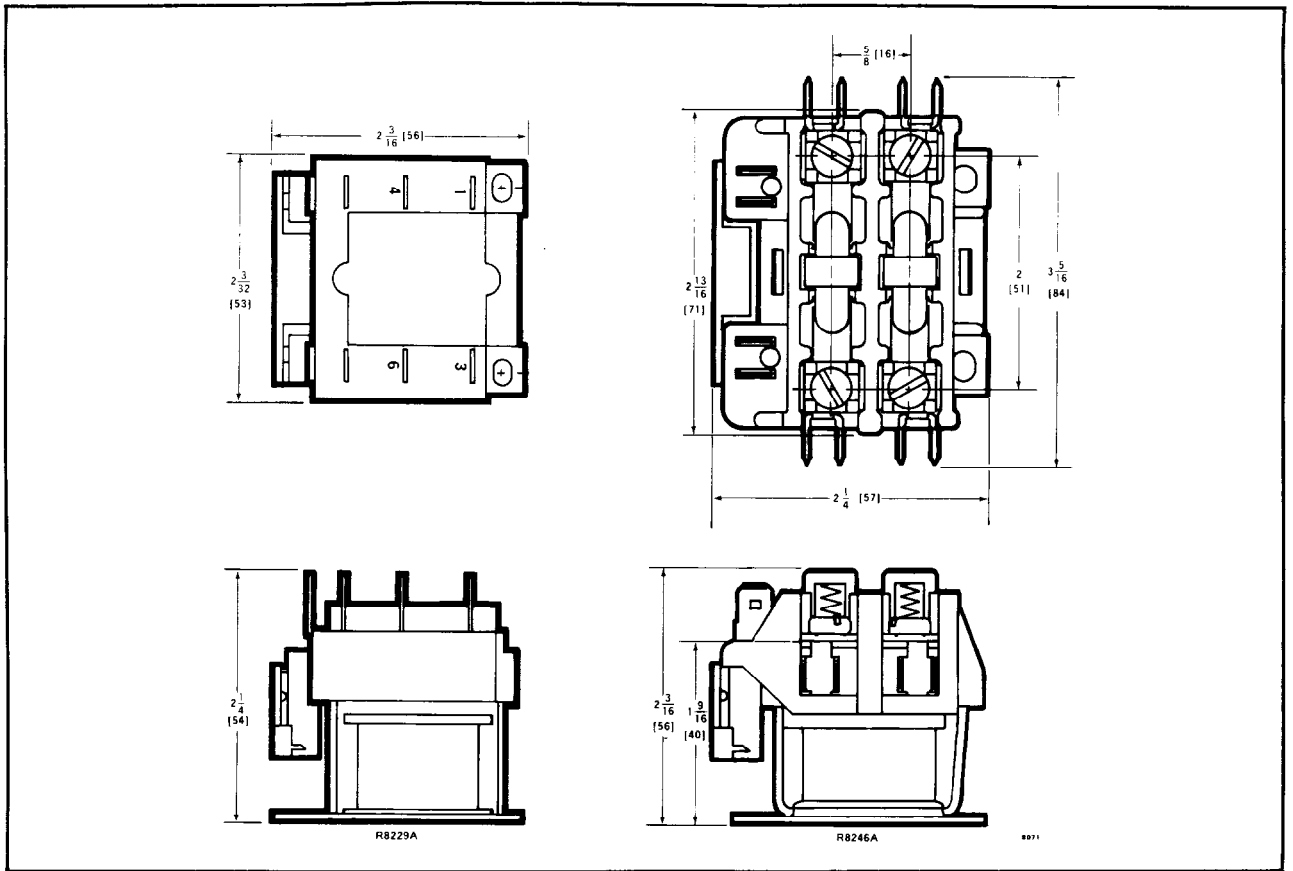

FIG. 2—R8229A ELECTRIC HEAT RELAY AND R8246 ELECTRIC HEAT CONTACTOR DIMENSIONS IN INCHES [MILLIMETRES].

CONTACT RATINGS:
R8229 ratings per pole—

VOLTAGE	FIRST POLE	SECOND POLE ^b				
	RESISTIVE ONLY AMPERES	COMBINED INDUCTIVE ^{a,b} AND RESISTIVE			INDUCTIVE ONLY	
		MAX. LOAD	INDUCTIVE		AFL	ALR
120, 208, 240, 277	25.0	26.0	6.4	18.0	7.0	35.0
480	12.5	13.6	3.2	9.0	3.5	17.5
600	10.0	10.4	2.56	7.2	2.8	14.0

R8246 ratings per pole—

VOLTAGE	FIRST POLE	SECOND POLE ^b				
	RESISTIVE ONLY AMPERES	COMBINED INDUCTIVE ^{a,b} AND RESISTIVE			INDUCTIVE ONLY	
		MAX. LOAD	INDUCTIVE		AFL	ALR
120, 208, 240, 277	48.0	48.0	7.0	42.0	12.0	72.0
480	24.0	24.0	3.5	21.0	6.0	36.0
600	19.2	18.5	2.8	16.8	4.8	28.8

^aEither contact of the R8229 is rated for a 5 kW resistive load in combination with the motor load as shown in the table. Either contact of the R8246 is rated for a 10 kW resistive load in combination with the motor load as shown in the table. The total connected second pole load (inductive and resistive loads combined) cannot exceed the value given in the table for MAX LOAD. FOR EXAMPLE: With a 5 amp motor load, up to 43.0 amp resistive can be controlled by the same pole of a R8246A contactor at 240V ac.

^bA combined resistive and inductive load can be connected to either pole of the relay and contactor. Do not connect an inductive load to both poles.

RECONTROL REPLACEMENT FOR APPLIANCES WITH LINE VOLTAGE OR PILOT DUTY LIMITS

REPLACEMENT FOR:

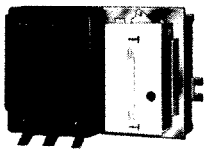

CAMSTAT

S106
S206
S306
S406
14-100
14-200
14-300
14-400

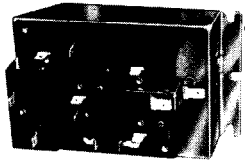

HONEYWELL

R4154A R8330B
R4154B R8330C
R4154C R8330D
R4154D R8330E
R8154A R8330F
R8154B R8330G
R8154C R8330H
R8154D R8330J
R8206A R8330K
R8206B W879A^a
R8206C W879B^a
R8330A W879C^a
W879D^a

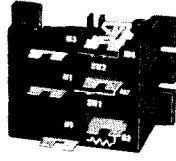

WHITE-RODGERS

24A11
24A12
24A14
24A20
24A21
24A22
24A51
24A52
24A53
24A54
24A55
24A56

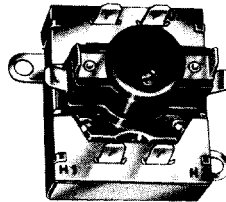

THERM-O-DISC

11S Series
12S Series
14S Series
15S Series

ROBERTSHAW

TDS Series

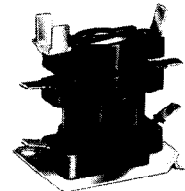

TEXAS INSTRUMENTS

511 Series
600 Series
602 Series
607 Series

RBM
189

^aComponents of a typical system include W879 Sequencing Panel, W879D add-on panel, R8330A Load Relays, R8301 Time Delay Relays, and AT20A,C, AT40A,C, or AT88A Transformers. Entire system must be replaced.

INSTALLATION

CAUTION

1. Installer must be a trained, experienced serviceman.
2. Disconnect power supply before connecting wiring to prevent electrical shock and equipment damage.
3. The fan must be controlled by the contactor connected to W1.
4. Conduct a thorough checkout after the installation is complete.

LOCATION

The design of the furnace and location of the original controls will guide R8229-R8246 location. Make sure the area selected is within the control's ambient temperature rating of 165 F [74 C]. The control may be mounted in any position inside the furnace enclosure. It cannot be mounted on the outside.

WIRING

All wiring must comply with applicable codes and ordinances. Refer to Manufacturer's wiring diagram if available. Figs. 6 to 9 show typical hookups using the R8229A and R8246A in different systems with up to 8 heating elements. Turn to the needed furnace system schematic.

1. Remove all existing controls that are in the heating element circuits. DO NOT REMOVE—

- Fan speed changeover relay.
- Fuse blocks and terminal strips.
- 24 volt transformer.
- Limits and cutouts on the heaters.

2. Remove all wiring except leads or wires from the—

- Low voltage terminal block.
- Changeover relay.
- Heating elements and limits.
- Line voltage fuse or terminal blocks.

3. Seal all old screw holes with screws or duct tape.

4. Use the control as a template and drill two 3/16 inch [4.8 mm] holes for each control in a convenient location. Mount the controls, using the screws on unexposed furnace surfaces. Use the nuts and bolts when mounting on a surface where the mounting hardware is exposed to the outside of the furnace.

5. Replacement of the female wiring terminals that connect to the R8229A or R8246A is recommended. Use the terminals supplied. Follow the schematic for the system you are servicing and:

- a. Reconnect low voltage thermostat, relay and contactor coils, and changeover relay wires.
- b. Reconnect the fan circuit. Be sure the fan leadwires are the same as the original to ensure proper fusing. The fan must be controlled by the relay or contactor connected to W1.

- c. Reconnect the heater element circuits one at a time. Make sure that the line voltage wires (L1) to the element(s) are connected with the same size fuse as the return line (L2) for each element. There should be no more than 2-5 kW elements (2 elements and fan in combination rated circuits) per fuse pair or contactor pole (1-5 kW element per relay pole).
- d. All pilot duty limits must be in the coil circuit of ALL relays and contactors, or a line voltage limit must remain wired with each heating element.

TABLE 1

NUMBER OF (5 kW OR LESS) HEATER ELEMENTS IN FURNACE	NUMBER OF R8229A RELAYS/ R8246A CONTACTORS REQUIRED	
	COMBINATION RATED FURNACE (FIGS. 6 AND 9)	ISOLATED FAN CIRCUIT FURNACE (FIGS. 7 AND 8)
1	1 R8229 (or 1 R8246)	1 R8229 (or 1 R8246)
2	1 R8229 (or 1 R8246)	1 R8246
3	1 R8246	2 R8229 or 1 R8246 + 1 R8229
4	1 R8246	1 R8246 + 1 R8229
5	1 R8246 + 1 R8229	1 R8246 + 1 R8229
6	1 R8246 + 1 R8229	2 R8246
7	2 R8246	2 R8246 + 1 R8229
8	2 R8246	2 R8246 + 1 R8229

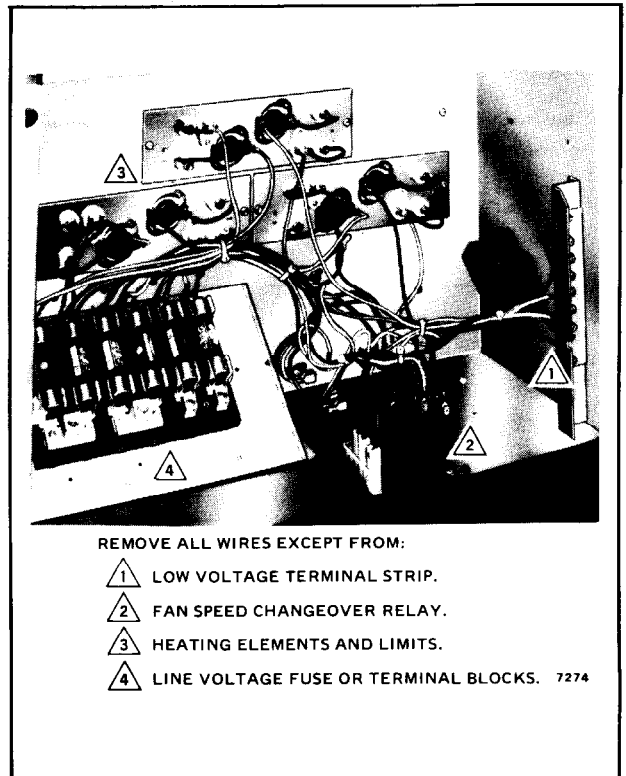

FIG. 4—REMOVE WIRING.

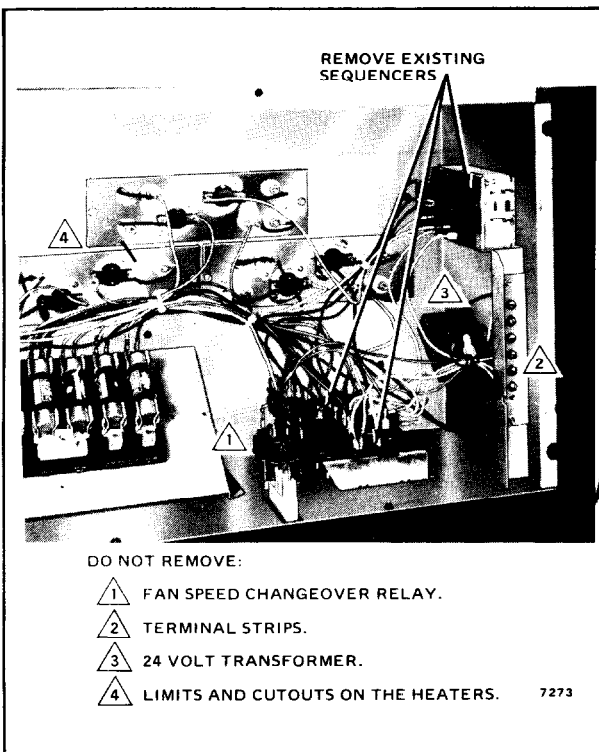

FIG. 3—REMOVE OLD SEQUENCERS.

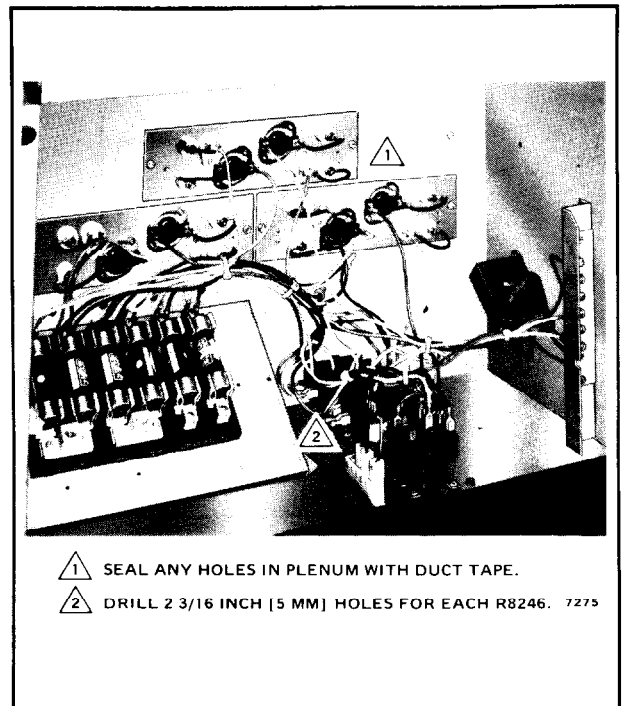

FIG. 5—INSTALL R8229A(S) AND R8246A(S).

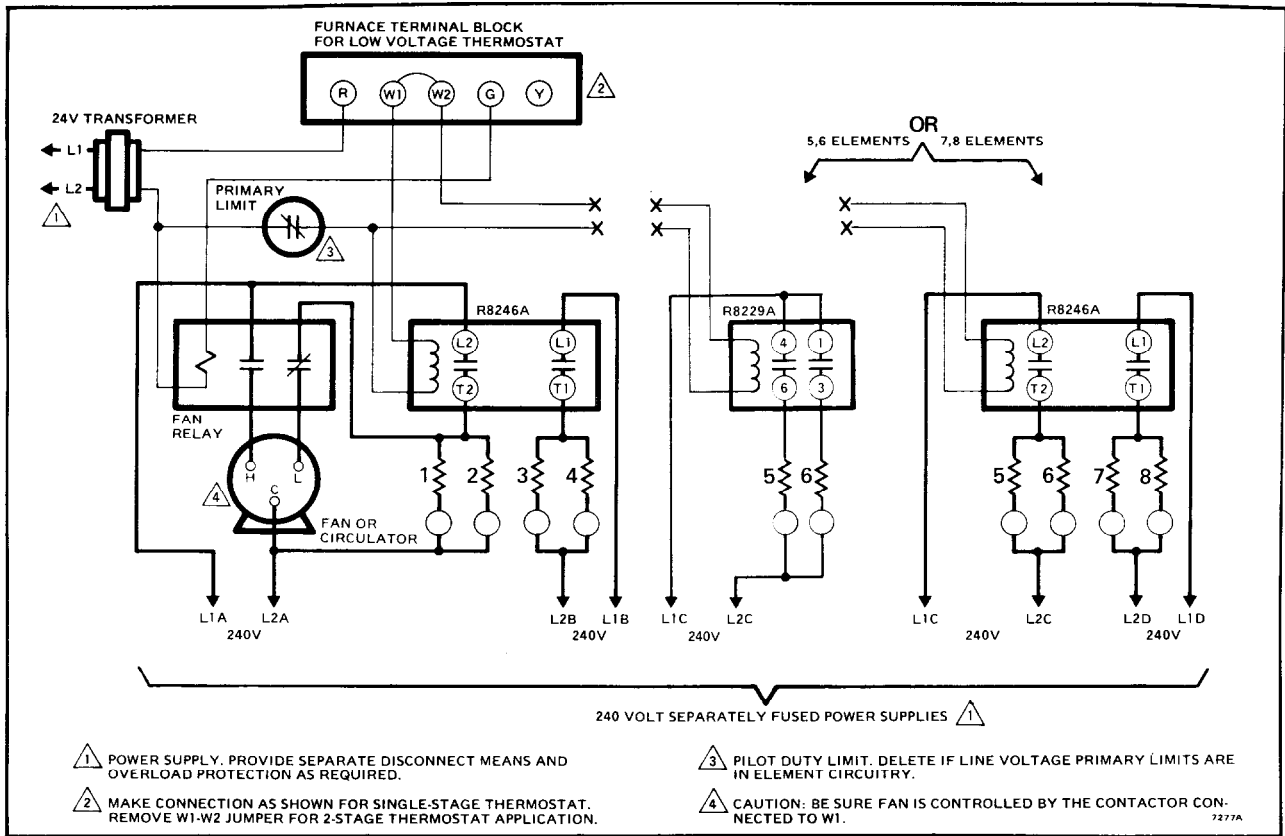

FIG. 6—COMBINATION RATED TWO-SPEED FAN CIRCUIT WITH PILOT DUTY LIMIT.

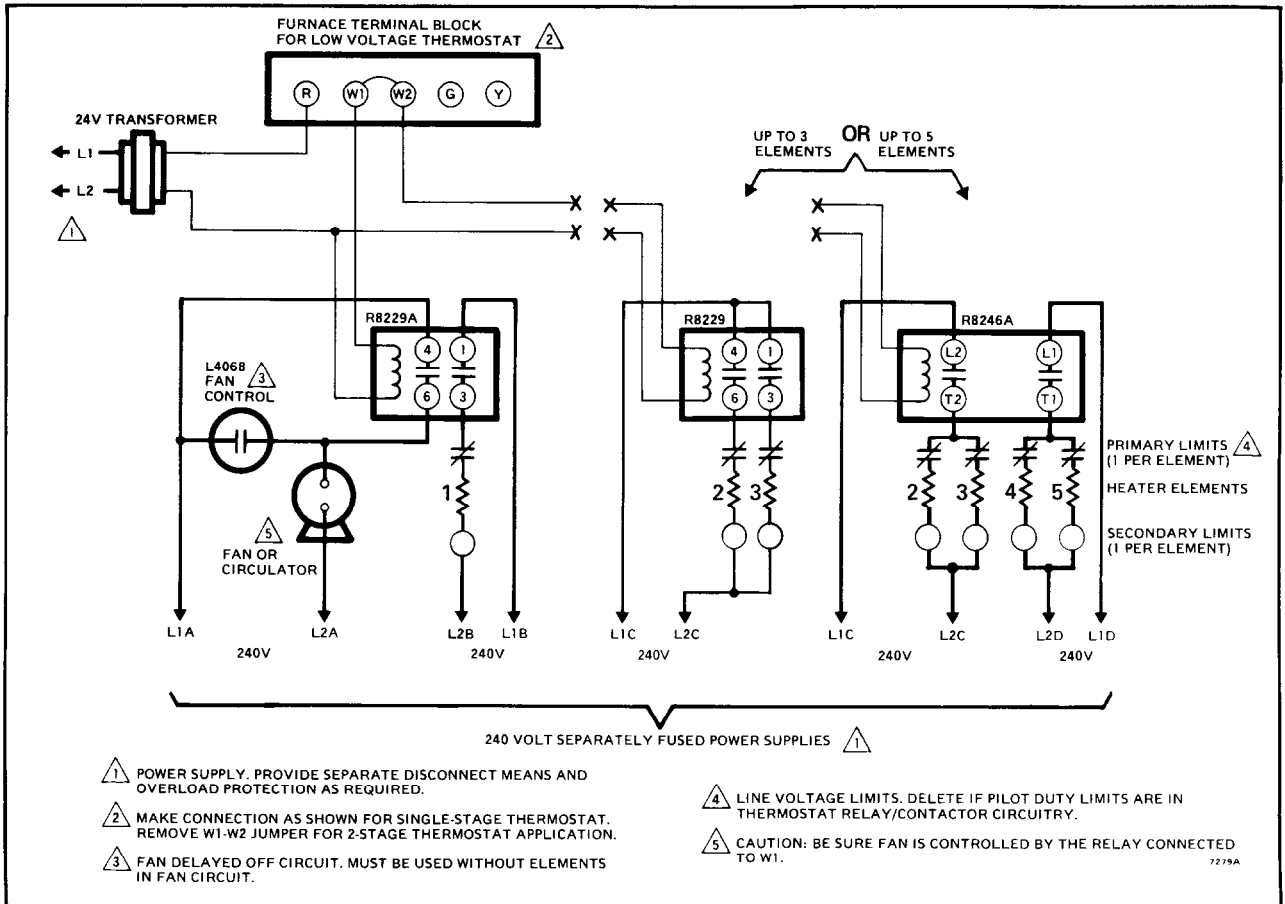

FIG. 7—DELAYED OFF FAN CONTROL IN ISOLATED FAN CIRCUIT WITH LINE VOLTAGE LIMITS.

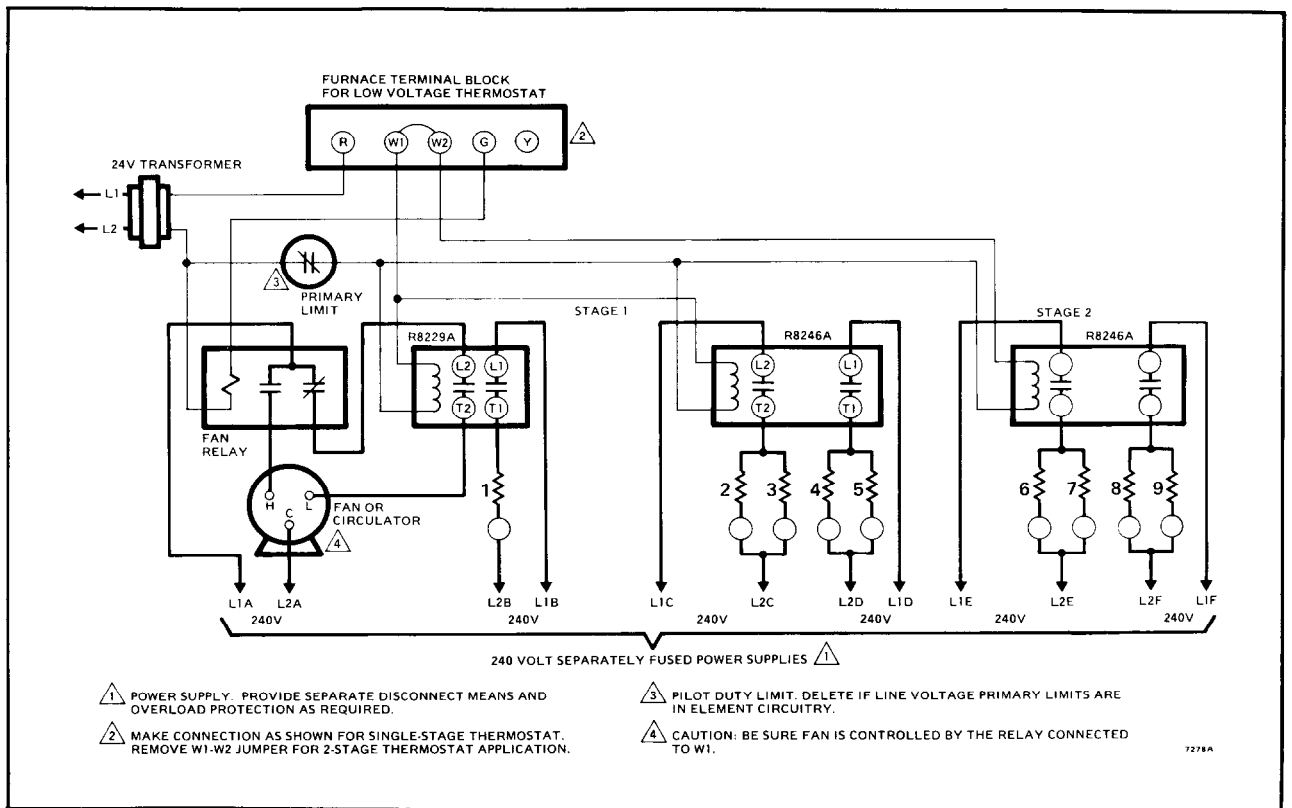

FIG. 8—240 VOLT, TWO-SPEED ISOLATED FAN WITH PILOT DUTY LIMIT.

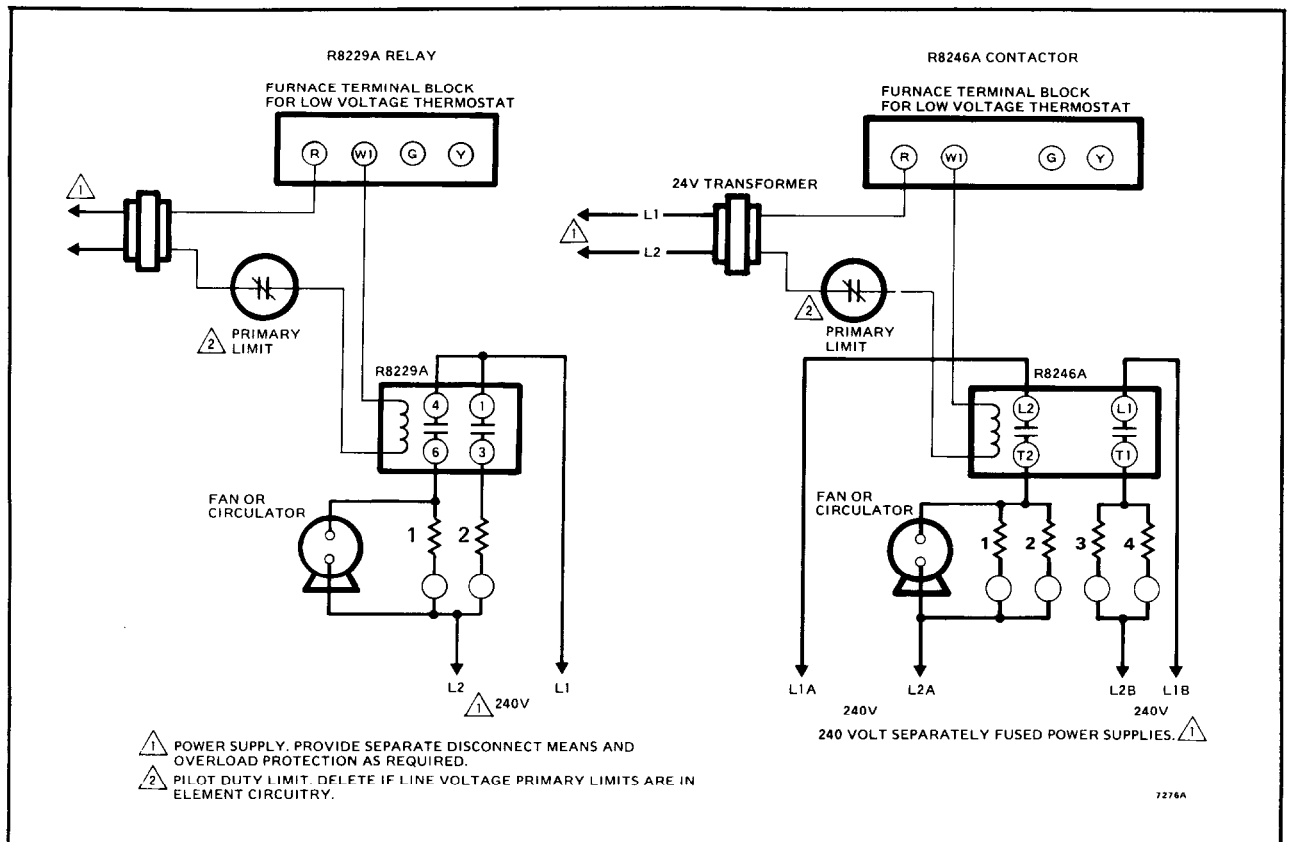

FIG. 9—COMBINATION RATED SINGLE-SPEED FAN CIRCUIT WITH PILOT DUTY LIMIT.



CHECKOUT AND SERVICE

CAUTION

The fan must be on whenever any heating elements are on.

limit systems, relay(s) and contactor(s) should drop out when control circuit is de-energized by the pilot duty limit. Perform system checkout procedure in TROUBLE-SHOOTING section.

CHECKOUT

Set the system thermostat to call for heat and make sure that all elements turn on and off properly and that fan starts and stops with the elements. In pilot duty

SERVICE

The R8229A and R8246A are not field repairable. If any component fails, the entire control should be replaced. No adjustment or periodic service is required on these controls.

TROUBLESHOOTING

CAUTION

The R8229A and R8246A contacts carry line voltage. Disconnect power supply before working with or checking wiring.

PRELIMINARY CHECKOUT FOR SYSTEM WITH LINE VOLTAGE LIMITS

1. Check system wiring for any loose or broken connections.

2. With power off, disconnect the fan at R8229A or R8246A. Turn power on and set the thermostat to call for heat. When the heater elements come on, check the limit controls on the heaters for proper operation. Replace any limit that does not de-energize its element.

Turn the thermostat to the lowest setting and turn power off. Reconnect the fan and turn the power on. Turn the furnace on and off to be sure the fan and all heating elements operate properly.

PRELIMINARY CHECKOUT FOR SYSTEM WITH PILOT DUTY LIMIT

1. Check system wiring for any loose or broken connections.

2. With power off, disconnect the fan at R8229A or R8246A. Turn power on and set the thermostat to call for heat. When furnace temperature rises to limit set point, the pilot duty limit should open the control circuit to de-energize the relay or contactor(s). All elements must turn off. Replace limit(s) which are not working properly.

Turn the thermostat to the lowest setting and turn power off. Reconnect the fan and turn the power on. Sequence the furnace on and off to be sure the fan and all heating elements operate properly.

NOTE: Check out systems with circulator by lowering pilot duty limit setting with the power on. The relay(s) or contactor(s) should drop out as in the above procedure when furnace temperature rises to limit set point. If limit has a nonadjustable setting, disconnect one of the transformer secondary leads at the contactor coil terminals. The relay(s) or contactor(s) should drop out. (**NOTE:** This does not check the function of the limit itself.) Be sure to reconnect leads at coil terminals.

TRANSFORMER CHECKOUT

1. Use an ac voltmeter to measure the voltage across the secondary terminals. If voltage is 24V ac \pm 10 percent, proceed to check the R8229A or R8246A. If incorrect, proceed to step 2.

2. Check that voltage across transformer primary is within \pm 10 percent of rated voltage. If correct, replace the transformer. If the primary voltage is incorrect, correct source problems.

R8229A AND R8246A SYSTEM CHECKOUT

Refer to applicable wiring diagrams. Note that if several R8229 relays and R8246A contactors are used in combination, the troubleshooting procedure must be adapted for the individual system.

1. Move the thermostat set point above the room temperature so that thermostat calls for heat—

- a. If system does not start, proceed to step 2.
- b. If fan and/or some heating elements start (but not all), proceed to step 3.
- c. If fan and heating elements all come on properly, proceed to step 4.

2. Jumper Rh to W1 at the thermostat—

- a. If fan and heating elements now begin operating, check thermostat and wiring and replace thermostat if necessary. Proceed to step 4.
- b. If neither fan nor heating elements operate (and system wiring was checked), replace the relay or contactor.

NOTE: See Preliminary Checkout for System with Pilot Duty Limit in systems with pilot duty limit before replacing relay or contactor.

CAUTION

The R8229A and R8246A contacts carry line voltage.

3. Jumper across the relay or contactor terminals controlling the inoperative fan or heating element. If the fan or element now starts, the contacts are not conducting; replace the relay or contactor.

NOTE: If element is not energized, check to see that second stage of thermostat is operating (or that R to W2 is jumpered for single-stage thermostat). In hookup with more than one R8229A or R8246A, check to see that control circuit wiring is as specified by the appropriate schematic.

4. When all elements and fan are on, break the power supply to the relay and contactor by lowering the thermostat set point (or removing jumper Rh-W1) so that switch breaks. Check to make sure that all heating stages turn off. The fan should turn off when the elements go off unless the fan is wired for delayed off (see Fig. 8).