

DAIKIN

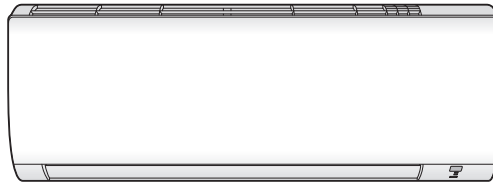

DAIKIN ROOM AIR CONDITIONER

INSTALLATION MANUAL

R410A Split Series



Installation manual
Manuel d'installation
Manual de instalación

English

Français

Español

MODELS

FTX09NMVJU	FTK09NMVJU
FTX12NMVJU	FTK12NMVJU
FTX18NMVJU	FTK18NMVJU
FTX24NMVJU	FTK24NMVJU
FTXN09NMVJU	FTKN09NMVJU
FTXN12NMVJU	FTKN12NMVJU
FTXN18NMVJU	FTKN18NMVJU
FTXN24NMVJU	FTKN24NMVJU

Contents

Safety Considerations	1	Refrigerant Piping Work	9
Accessories	3	1. Flaring the pipe end.....	9
Choosing an Installation Site	3	2. Refrigerant piping.....	9
1. Indoor unit	3	Installation Tips	10
2. Wireless remote controller.....	3	1. Removing and installing the front panel	10
Indoor Unit Installation Drawings	4	2. Removing and installing the front grille.....	11
Indoor Unit Installation	5	3. How to set the different addresses	11
1. Installing the mounting plate.....	5	Trial Operation and Testing	12
2. Drilling a wall hole and installing wall embedded pipe.....	6	1. Trial operation and testing	12
3. Installing the indoor unit	6	2. Test items	12
4. Wiring	8		
5. Drain piping	8		

Safety Considerations

- Read these **Safety Considerations** carefully to ensure correct installation.
- This manual classifies the precautions into **DANGER**, **WARNING** and **CAUTION**.
Be sure to follow all the precautions below: they are all important for ensuring safety.

 **DANGER** Indicates an imminently hazardous situation which, if not avoided, will result in death or serious injury.

 **WARNING** Failure to follow any of **WARNING** is likely to result in such grave consequences as death or serious injury.

 **CAUTION** Failure to follow any of **CAUTION** may in some cases result in grave consequences.

- After completing installation, test the unit to check for installation errors. Give the user adequate instructions concerning the use and cleaning of the unit according to the Operation Manual.

DANGER

- Refrigerant gas is heavier than air and replaces oxygen. A massive leak could lead to oxygen depletion, especially in basements, and an asphyxiation hazard could occur leading to serious injury or death.
- If the refrigerant gas leaks during installation, ventilate the area immediately.
Refrigerant gas may produce a toxic gas if it comes in contact with fire such as from a fan heater, stove or cooking device.
Exposure to this gas could cause severe injury or death.
- After completing the installation work, check that the refrigerant gas does not leak.
Refrigerant gas may produce a toxic gas if it comes in contact with fire such as from a fan heater, stove or cooking device.
Exposure to this gas could cause severe injury or death.
- Do not ground units to water pipes, telephone wires or lightning rods because incomplete grounding could cause a severe shock hazard resulting in severe injury or death, and to gas pipes because a gas leak could result in an explosion which could lead to severe injury or death.
- Safely dispose of the packing materials.
Packing materials, such as nails and other metal or wooden parts, may cause stabs or other injuries.
Tear apart and throw away plastic packaging bags so that children will not play with them.
Children playing with plastic bags face the danger of death by suffocation.

- Do not install unit in an area where flammable materials are present due to risk of explosion resulting in serious injury or death.
- Do not ground units to telephone wires or lightning rods because lightning strikes could cause a severe shock hazard resulting in severe injury or death, and to gas pipes because a gas leak could result in an explosion which could lead to severe injury or death.

WARNING

- Installation shall be left to the authorized dealer or another trained professional.
Improper installation may cause water leakage, electrical shock, fire, or equipment damage.
- Install the air conditioner according to the instructions given in this manual.
Incomplete installation may cause water leakage, electrical shock, fire or equipment damage.
- Be sure to use the supplied or exact specified installation parts.
Use of other parts may cause the unit to come to fall, water leakage, electrical shock, fire or equipment damage.
- Install the air conditioner on a solid base that is level and can support the weight of the unit.
An inadequate base or incomplete installation may cause injury or equipment damage in the event the unit falls off the base or comes loose.
- Electrical work shall be carried out in accordance with the installation manual and the national, state and local electrical wiring codes.
Insufficient capacity or incomplete electrical work may cause electrical shock, fire or equipment damage.
- Be sure to use a dedicated power circuit. Never use a power supply shared by another appliance.
Follow all appropriate electrical codes.
- For wiring, use a wire or cable long enough to cover the entire distance with no splices if possible.
Do not use an extension cord. Do not put other loads on the power supply.
Use only a separate dedicated power circuit.
(Failure to do so may cause abnormal heat, electric shock, fire or equipment damage.)
- Use the specified types of wires for electrical connections between the indoor and outdoor units.
Follow all state and local electrical codes.
Firmly clamp the inter-unit wire so their terminals receive no external stresses.
Incomplete connections or clamping may cause terminal overheating, fire or equipment damage.
- After connecting all wires be sure to shape the cables so that they do not put undue stress on the electrical covers, panels or terminals.
Install covers over the wires. Incomplete cover installation may cause terminal overheating, electrical shock, fire or equipment damage.

- When installing or relocating the system, be sure to keep the refrigerant circuit free from all substances other than the specified refrigerant (R410A), such as air.
(Any presence of air or other foreign substance in the refrigerant circuit causes an abnormal pressure rise which may result in rupture, resulting in injury.)
- During pump down, stop the compressor before removing the refrigerant piping.
If the compressor is still running and the stop valve is open during pump down, air will be sucked in when the refrigerant piping is removed, causing abnormally high pressure which could lead to equipment damage or and personal injury.
- During installation, attach the refrigerant piping securely before running the compressor.
If the refrigerant pipes are not attached and the stop valve is open during installation, air will be sucked in when the compressor is run, causing abnormally high pressure which could lead to equipment damage and personal injury.
- Be sure to install a ground fault circuit interrupter.
Failure to install a ground fault circuit interrupter may result in electrically shocks, or fire personal injury.

CAUTION

- Do not install the air conditioner where gas leakage would be exposed to open flames.
If the gas leaks and builds up around the unit, it may catch fire.
- Establish drain piping according to the instructions of this manual.
Inadequate piping may cause water damage.
- Tighten the flare nut according to the specified torque. A torque wrench should be used.
If the flare nut is tightened too much, the flare nut may crack over time and cause refrigerant leakage.
- Do not touch the heat exchanger fins.
Improper handling may result in injury.
- Be very careful about product transportation.
Some products use PP bands for packaging. Do not use any PP bands for a means of transportation. It is dangerous.
- Electrical work must be performed in accordance with the NEC/CEC by authorized personnel only.

Accessories

Ⓐ Mounting plate	1	Ⓑ Mounting plate fixing screw 3/16" × 1" (M4 × 25mm)	7	Ⓒ Titanium apatite photocatalytic air-purifying filter *1*2	2
Ⓓ Wireless remote controller	1	Ⓔ Remote controller holder	1	Ⓕ Fixing screw for remote controller holder 1/8" × 13/16" (M3 × 20mm)	2
Ⓖ Dry battery AAA. LR03(alkaline)	2	Ⓗ Indoor unit fixing screw 3/16" × 1/2" (M4 × 12mm)	2	Ⓖ Insulation tape	1
Ⓚ Operation manual	1	Ⓛ Installation manual	1		

1 Only for FTX(K)09/12/18/24

*2 09/12 class: without frame
18/24 class: with frame

Choosing an Installation Site

Before choosing the installation site, obtain user approval.

1. Indoor unit

The indoor unit should be positioned in a place where:

- 1) the restrictions on the installation requirements specified in “**Indoor unit installation drawings**” on page 4 are met,
- 2) both the air inlet and air outlet are unobstructed,
- 3) the unit is not exposed to direct sunlight,
- 4) the unit is away from sources of heat or steam,
- 5) there is no source of machine oil vapour (this may shorten the indoor unit service life),
- 6) cool/warm air is circulated throughout the room,
- 7) the unit is away from electronic ignition type fluorescent lamps (inverter or rapid start type) as they may affect the remote controller range,
- 8) the unit is at least 3.3ft (1m) away from any television or radio set (the unit may cause interference with the picture or sound),
- 9) no laundry equipment is nearby.

2. Wireless remote controller

Turn on all the fluorescent lamps in the room, if any, and find a location where the remote controller signals are properly received by the indoor unit (within 23ft (7m)).

Indoor Unit Installation Drawings

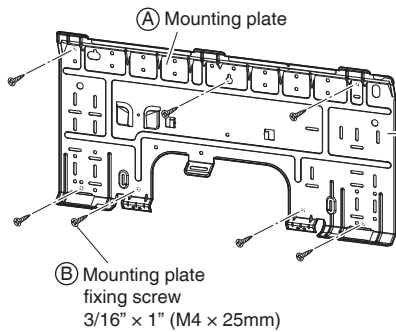

■ **How to attach the indoor unit**
Hook the hooks of the bottom frame to the (A) mounting plate. If the hooks are difficult to hook, remove the front grille.

■ **How to remove the indoor unit**
Push up the marked area (at the lower part of the front grille) to release the hooks. If it is difficult to release, remove the front grille.

The (A) mounting plate should be installed on a wall which can support the weight of the indoor unit.

1-3/16" (30mm) or more from ceiling

1-15/16" (50mm) or more from walls (on both sides)

Front panel

Air filters

Screws
3/16" x 5/8" (M4 x 16mm)*
*The 18 and 24-class models have 3 screws.

Caulk pipe hole gap with putty.

Cut thermal insulation pipe to an appropriate length and wrap it with tape, making sure that no gap is left in the insulation pipe's cut line.

Wrap the insulation pipe with the finishing tape from bottom to top.

Appearance of indoor units may differ from some models. (This is a 09/12 class illustration)

Service lid
The service lid is removable.

■ **Opening method**

- 1) Remove the service lid screw.
- 2) Pull out the service lid horizontally in the direction of the arrow.
- 3) Pull down.

(C) Titanium apatite photocatalytic air-purifying filter (2)
(FTXN or FTKN models: Sold separately.)

09/12 class

Titanium apatite photocatalytic air-purifying filter

18/24 class

Filter frame

Titanium apatite photocatalytic air-purifying filter

Claw

Tab

Air filter

(D) Wireless remote controller

(E) Remote controller holder

(F) Fixing screw for remote controller holder
1/8" x 13/16" (M3 x 20mm)

Before screwing the (E) remote controller holder to the wall, make sure that control signals are properly received by indoor unit.

Indoor Unit Installation

1. Installing the mounting plate

- The mounting plate should be installed on a wall which can support the weight of the indoor unit.
 - Temporarily secure the mounting plate to the wall, make sure that the panel is completely level, and mark the drilling points on the wall.
 - Secure the mounting plate to the wall with screws.

Recommended mounting plate retention spots and dimensions

09/12 class

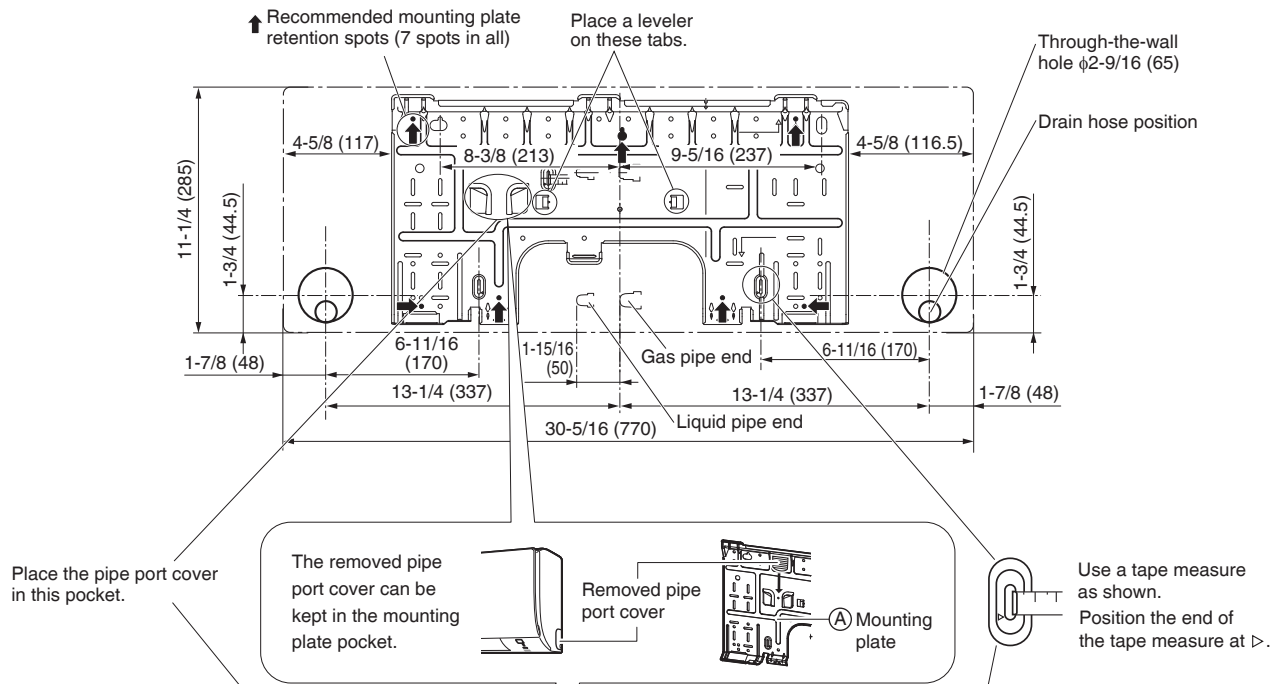

18/24 class

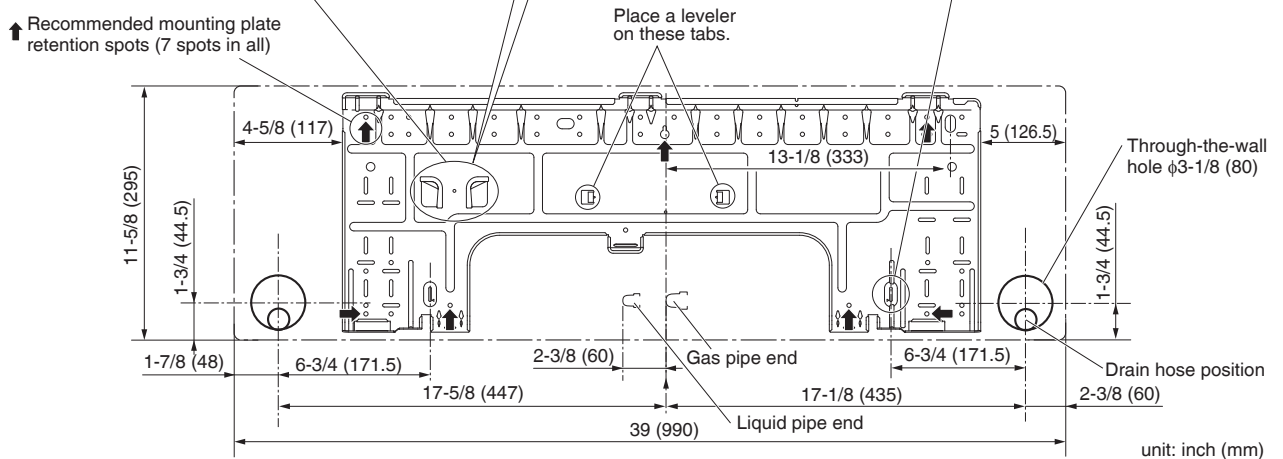

2. Drilling a wall hole and installing wall embedded pipe

- For metal frame or metal board walls, be sure to use a wall embedded pipe and wall hole cover in the feed-through hole to prevent possible heat, electrical shock, or fire.
- Be sure to caulk the gaps around the pipes with caulking material to prevent water leakage.
 - 1) Drill a feed-through hole with a $\phi 2\text{-}9/16$ inch (65mm) (for 09/12 class), $\phi 3\text{-}1/8$ inch (80mm) (for 18/24 class) diameter through the wall at a downward angle toward the outside.
 - 2) Insert a wall embedded pipe into the hole.
 - 3) Insert a wall hole cover into wall pipe.
 - 4) After completing refrigerant piping, wiring, and drain piping, caulk the pipe hole gap with putty.

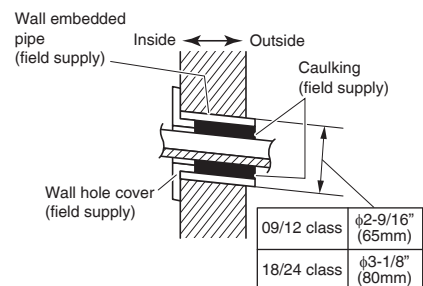

3. Installing the indoor unit

In the case of bending or curing refrigerant pipes, keep the following precautions in mind.
Abnormal sound may be generated if improper work is conducted.

- Do not strongly press the refrigerant pipes onto the bottom frame.
- Do not strongly press the refrigerant pipes on the front grille, either.

3-1. Right-side, right-back, or right-bottom piping

- 1) Attach the drain hose to the underside of the refrigerant pipes with adhesive vinyl tape.
- 2) Wrap the refrigerant pipes and drain hose together with \textcircled{J} insulation tape.

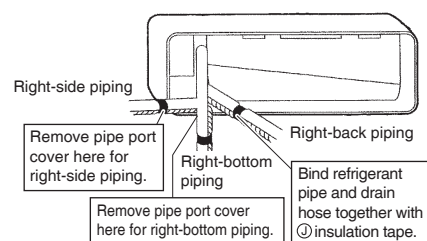

- 3) Pass the drain hose and refrigerant pipes through the wall hole, then set the indoor unit on the \textcircled{A} mounting plate hooks by using the \triangle markings at the top of the indoor unit as a guide.

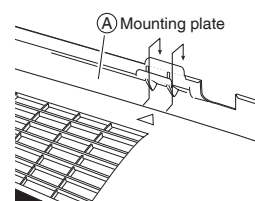

- 4) Open the front panel (Refer to "Installation Tips" on page 10), then open the service lid (Refer to "Indoor Unit Installation Drawings" on page 4).
- 5) Pass the inter-unit wire from the outdoor unit through the feed-through wall hole and pass to the front of indoor unit from the back. Then pull them at front side. Bend the ends of cable tie wires upward for easier work in advance.
- 6) Press the bottom frame of the indoor unit with both hands to set it on the \textcircled{A} mounting plate hooks. Make sure the wire leads do not catch on the edge of the indoor unit.

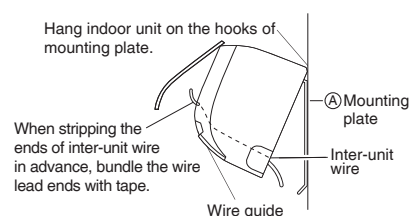

Indoor Unit Installation

3-2. Left-side, left-back, or left-bottom piping

How to replace the drain plug and drain hose

• Replacing onto the left side

- 1) Remove the fixing screw of drain hose on the right and remove the drain hose.
- 2) Remove the drain plug on the left side and attach it to the right side.
- 3) Insert the drain hose and tighten with the included fixing screw.
Forgetting to tighten this may cause water leakages.

Drain hose attachment position

The drain hose is on the back of the unit.

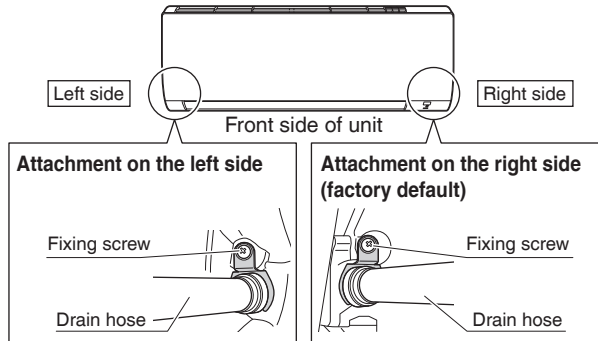

- 1) Attach the drain hose to the underside of the refrigerant pipes with adhesive vinyl tape.

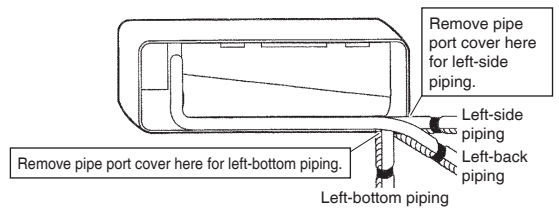

- 2) Be sure to connect the drain plug to the drain port in place of without drain hose.

How to set the drain plug.

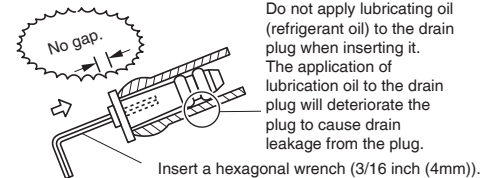

Do not apply lubricating oil (refrigerant oil) to the drain plug when inserting it. The application of lubrication oil to the drain plug will deteriorate the plug to cause drain leakage from the plug.

- 3) Shape the refrigerant pipes along the pipe path marking on the (A) mounting plate.
- 4) Pass the drain hose and refrigerant pipes through the wall hole, then position the indoor unit on the (A) mounting plate hooks, using the Δ markings at the top of the indoor unit as a guide.
- 5) Pull in the inter-unit wire.
- 6) Connect the inter-unit pipes.

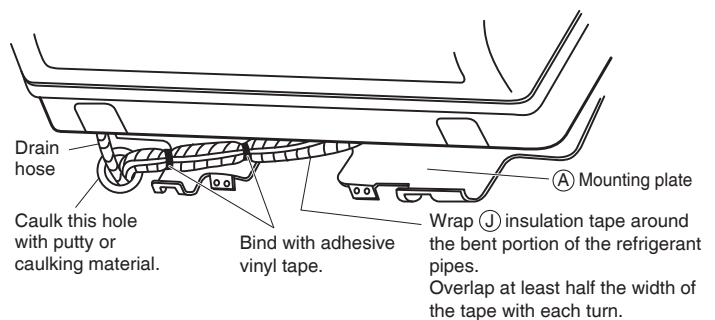

- 7) In case of pulling the drain hose through the back of the indoor unit, wrap the refrigerant pipes and drain hose together with (J) insulation tape as shown in the right figure.
- 8) To confirm that the inter-unit wire does not catch by the indoor unit, press the bottom edge of the indoor unit with both hands until it is firmly caught by the (A) mounting plate hooks. Secure the indoor unit to the (A) mounting plate with the (H) indoor unit fixing screws $3/16" \times 1/2"$ (M4 \times 12mm).

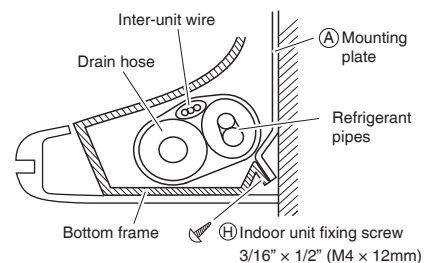

3-3. Wall embedded piping

Follow the instructions given under left-side, left-back, or left-bottom piping.

- 1) Insert the drain hose to this depth so it won't be pulled out of the drain pipe.

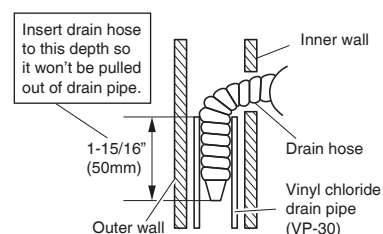

4. Wiring

- 1) As shown in the illustration, insert the wires including the ground wire into the conduit and secure them with lock nut onto the conduit mounting plate.
- 2) Strip wire ends (3/4 inch (20mm)).
- 3) Match wire colours with terminal numbers on the terminal block of indoor and outdoor unit and firmly secure the wires in the corresponding terminals with screws.
- 4) Connect the ground wire to the corresponding terminals.
- 5) Pull the wires lightly to make sure they are securely connected.
- 6) While close the service lid, shape the wires so that the service lid fits securely, then close the service lid.

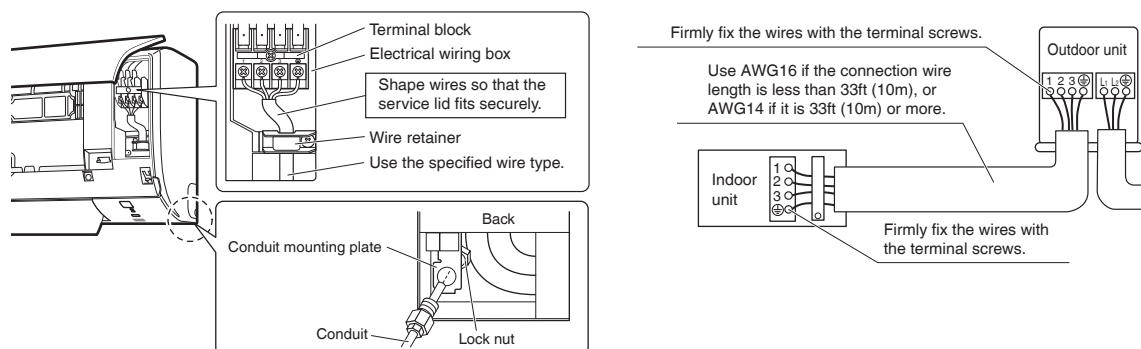

⚠ WARNING

- Do not use tapped wires, extension cords, or starburst connections, as they may cause overheating, electrical shock, or fire.
- Do not use locally purchased electrical parts inside the product. (Do not branch the power for the drain pump, etc., from the terminal block.) Doing so may cause electric shock or fire.
- Do not connect the power wire to the indoor unit. Doing so may cause electric shock or fire.

5. Drain piping

- 1) Connect the drain hose, as described on the right.

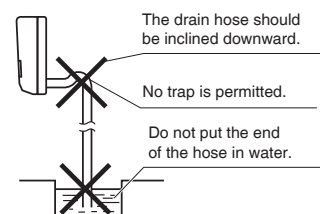

- 2) Remove the air filters and pour some water into the drain pan to check the water flows smoothly.

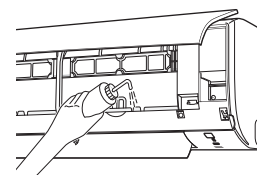

- 3) If drain hose extension or embedded drain piping is required, use appropriate parts that match the hose front end.

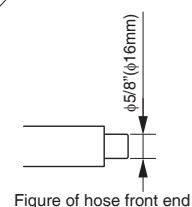

- 4) When extending the drain hose, use a commercially available extension hose with an inner diameter of 5/8 inch (16mm). Be sure to thermally insulate the indoor section of the extension hose.

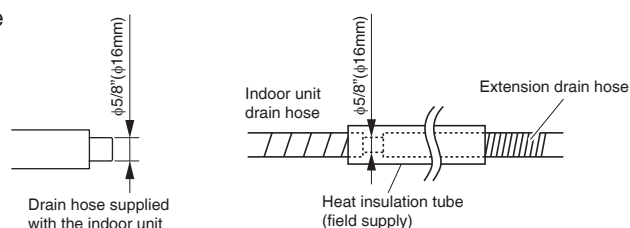

Refrigerant Piping Work

1. Flaring the pipe end

- 1) Cut the pipe end with a pipe cutter.
- 2) Remove burrs with the cut surface facing downward so that the chips do not enter the pipe.
- 3) Put the flare nut on the pipe.
- 4) Flare the pipe.
- 5) Check that the flaring is properly made.

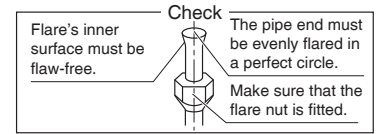
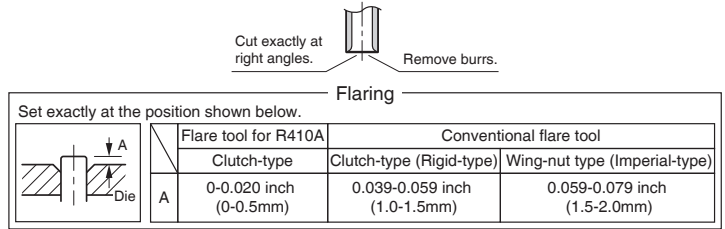

⚠ WARNING

- Do not use mineral oil on flared part.
- Prevent mineral oil from getting into the system as this would reduce the lifetime of the units.
- Never use piping which has been used for previous installations. Only use parts which are delivered with the unit.
- Never install a drier to this R410A unit in order to guarantee its lifetime.
- The drying material may dissolve and damage the system.
- Incomplete flaring may cause refrigerant gas leakage.

2. Refrigerant piping

⚠ CAUTION

- Use the flare nut fixed to the main unit. (This is to prevent cracking of the flare nut as a result of deterioration over time.)
- To prevent gas leakage, apply refrigeration oil only to the inner surface of the flare. (Use refrigeration oil for R410A.)
- Use a torque wrench when tightening the flare nuts to prevent damage to the flare nuts and gas leakage.

- Align the centers of both flares and tighten the flare nuts 3 or 4 turns by hand. Then tighten them fully with a spanner and a torque wrench.

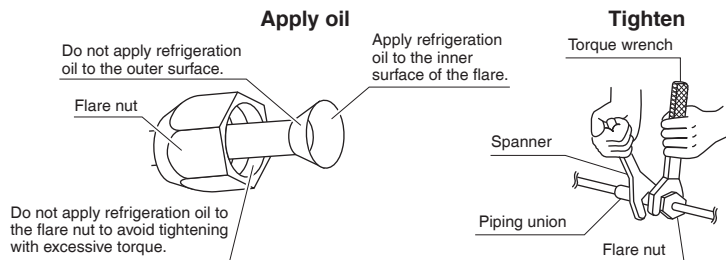

Flare nut tightening torque			
Gas side			Liquid side
3/8 inch (9.5mm)	1/2 inch (12.7mm)	5/8 inch (15.9mm)	1/4 inch (6.4mm)
24-1/8 - 29-1/2ft • lbf (32.7-39.9N • m)	36-1/2 - 44-1/2ft • lbf (49.5-60.3N • m)	45-5/8 - 55-5/8ft • lbf (61.8-75.4N • m)	10-1/2 - 12-3/4ft • lbf (14.2-17.2 N • m)

2-1. Caution on piping handling

- Protect the open end of the pipe against dust and moisture.
- All pipe bends should be as gentle as possible. Use a pipe bender for bending.

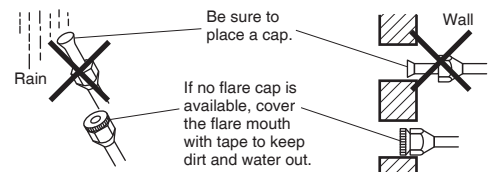

2-2. Selection of copper and heat insulation materials

When using commercial copper pipes and fittings, observe the following:

- Insulation material: Polyethylene foam
Heat transfer rate: 0.041 to 0.052W/mK (0.024 to 0.030Btu/fth°F (0.035 to 0.045kcal/mh°C))
Be sure to use insulation that is designed for use with HVAC Systems.
- ACR Copper only.

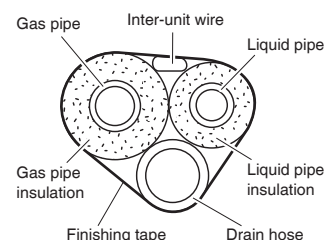

- Be sure to insulate both the gas and liquid piping and observe the insulation dimensions as below.

	Piping size	Minimum bend radius	Piping thickness	Thermal insulation size	Thermal insulation thickness
Gas side	O.D. 3/8 inch (9.5mm)	1-3/16 inch (30mm) or more	0.031 inch (0.8mm) (C1220T-O)	I.D. 15/32-19/32 inch (12-15mm)	13/32 inch (10mm) Min.
	O.D. 1/2 inch (12.7mm)	1-9/16 inch (40mm) or more		I.D. 9/16-5/8 inch (14-16mm)	
	O.D. 5/8 inch (15.9mm)	1-15/16 inch (50mm) or more	0.039 inch (1.0mm) (C1220T-O)	I.D. 5/8-13/16 inch (16-20mm)	
Liquid side	O.D. 1/4 inch (6.4mm)	1-3/16 inch (30mm) or more	0.031 inch (0.8mm) (C1220T-O)	I.D. 5/16-13/32 inch (8-10mm)	

- Use separate thermal insulation pipes for gas and liquid refrigerant pipes.

Installation Tips

1. Removing and installing the front panel

• Removal method

- 1) Place your fingers in the indentations on the main unit (one each on the left and right sides), and open the front panel until it stops.

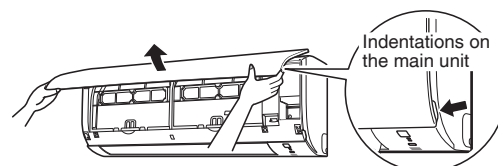

- 2) While pushing the left side front panel shaft outward, push up the front panel and remove it. (Remove the right side front panel shaft in the same manner.)
- 3) After removing both front panel shafts, pull the front panel toward yourself and remove it.

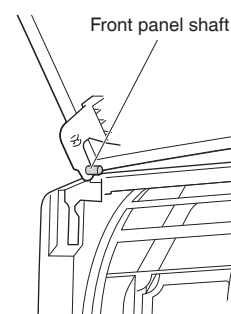

• Installation method

Align the shaft of the front panel with the grooves of grill, and push all the way in. Then close slowly. Push the center of the lower panel surface firmly to engage the hooks.

2. Removing and installing the front grille

• Removal method

- 1) Remove the front panel to remove the air filter.
- 2) Remove the 2 screws from the front grille.
(The 18 and 24-class models have 3 screws.)
- 3) In front of the ○○○ mark on the front grille, there are 3 upper hooks. Lightly pull the front grille toward you with one hand, and push down on the hooks with the fingers of your other hand.

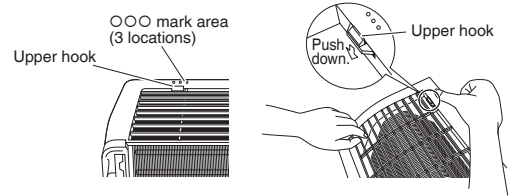

When there is insufficient work space because the unit is close to ceiling

⚠ CAUTION

- Be sure to wear protection gloves.

Place both hands under the center of the front grille, and while pushing up, pull it toward you.

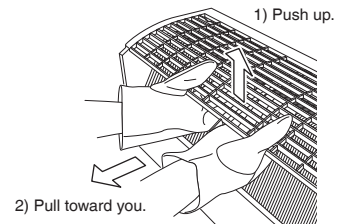

• Installation method

- 1) Install the front grille and firmly engage the upper hooks (3 locations).
- 2) Install 2 screws of the front grille.
(The 18 and 24-class models have 3 screws.)
- 3) Install the air filter and then mount the front panel.

3. How to set the different addresses

When 2 indoor units are installed in one room, the 2 wireless remote controllers can be set for different addresses. Change the address setting of one of the two units. When cutting the jumper be careful not to damage any of the surrounding parts.

- 1) Remove the battery cover on the remote controller and cut the address jumper.
- 2) Press **TEMP F/C** (up), **TEMP F/C** (down), and **OFF** at the same time.
- 3) Press **TEMP F/C** (up), then select **F**, press **FAN**.
(The indoor unit OPERATION lamp will blink for about 1 minute.)
- 4) Press the indoor unit ON/OFF switch while the OPERATION lamp is blinking.

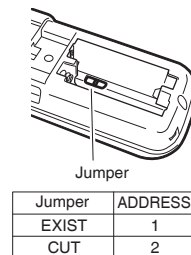

- If setting could not be carried out completely while the OPERATION lamp was blinking, carry out the setting process once again from the beginning.
- After setting is complete, pressing **FAN** for about 5 seconds will cause the remote controller to return to the previous display.

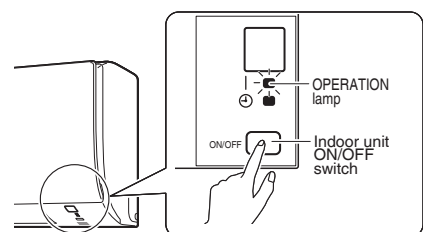

Trial Operation and Testing

1. Trial operation and testing

- Trial operation should be carried out in either COOL or HEAT operation.

1-1. Measure the supply voltage and make sure that it is within the specified range.









1-2. In COOL operation, select the lowest programmable temperature; in HEAT operation, select the highest programmable temperature.

1-3. Carry out the trial operation in accordance with the operation manual to ensure that all functions and parts, such as flap movement, are working properly.

- For protection, the system disables restart operation for 3 minutes after it is turned off.

1-4. After trial operation is complete, set the temperature to a normal level (78°F to 82°F (26°C to 28°C) in COOL operation, 68°F to 75°F (20°C to 24°C) in HEAT operation).

- When operating the air conditioner in COOL operation in winter, or HEAT operation in summer, set it to the trial operation mode using the following method.

- 1) Press ,  and  at the same time.
- 2) Press , then select , press .
- 3) Press  or  to turn on the system.
 - Trial operation will stop automatically after about 30 minutes. To stop the operation, press .
 - Some of the functions cannot be used in the trial operation mode.

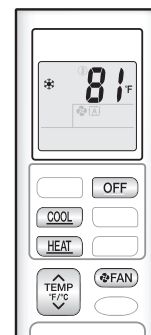

HEAT PUMP model

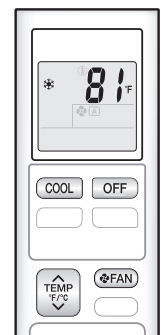

COOLING ONLY model

- The air conditioner draws a small amount of power in its standby mode. If the system is not to be used for some time after installation, shut off the circuit breaker to eliminate unnecessary power consumption.
- If the circuit breaker trips to shut off the power to the air conditioner, the system will restore the original operation mode when the circuit breaker is opened again.

2. Test items

Test items	Symptom	Check
Indoor and outdoor units are installed properly on solid bases.	Fall, vibration, noise	
No refrigerant gas leaks.	Incomplete cooling/heating function	
Refrigerant gas and liquid pipes and indoor drain hose extension are thermally insulated.	Water leakage	
Draining line is properly installed.	Water leakage	
System is properly grounded.	Electrical leakage	
The specified wires are used for inter-unit wiring.	No operation or burn damage	
Indoor or outdoor unit's air inlet or air outlet are unobstructed.	Incomplete cooling/heating function	
Stop valves are opened.	Incomplete cooling/heating function	
Indoor unit properly receives remote control commands.	No operation	

DAIKIN

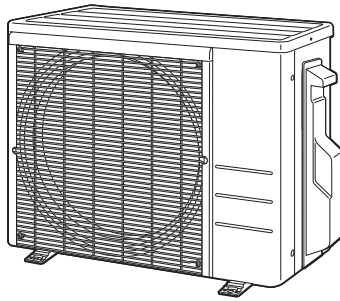

DAIKIN ROOM AIR CONDITIONER

INSTALLATION MANUAL

R410A Split Series



Installation manual
Manuel d'installation
Manual de instalación

English

Français

Español

MODELS

RX09NMVJU	RK09NMVJU
RX12NMVJU	RK12NMVJU
RX18NMVJU	RK18NMVJU
RX24NMVJU	RK24NMVJU
RXN09NMVJU	RKN09NMVJU
RXN12NMVJU	RKN12NMVJU
RXN18NMVJU	RKN18NMVJU
RXN24NMVJU	RKN24NMVJU

Contents

Safety Considerations	1	4. Refrigerant piping	6
Accessories	3	5. Pressure test and evacuating system.....	7
Precautions for Selecting the Location	3	6. Refilling refrigerant	8
Precautions on Installation	4	7. Refrigerant piping work	8
Outdoor Unit Installation Drawings	4	Wiring	9
Installation Guidelines	5	Facility Setting	
Outdoor Unit Installation	5	(cooling at low outdoor temperature)	11
1. Installing the outdoor unit	5	Pump Down Operation	11
2. Drain work (only for heat pump models).....	6	Trial Operation and Testing	12
3. Flaring the pipe end.....	6	1. Trial operation and testing	12
		2. Test items	12

Safety Considerations

- Read these **Safety Considerations** carefully to ensure correct installation.
- This manual classifies the precautions into **DANGER**, **WARNING** and **CAUTION**.
Be sure to follow all the precautions below: they are all important for ensuring safety.

 **DANGER** Indicates an imminently hazardous situation which, if not avoided, will result in death or serious injury.

 **WARNING** Failure to follow any of **WARNING** is likely to result in such grave consequences as death or serious injury.

 **CAUTION** Failure to follow any of **CAUTION** may in some cases result in grave consequences.

- After completing installation, test the unit to check for installation errors. Give the user adequate instructions concerning the use and cleaning of the unit according to the Operation Manual.

DANGER _____

- Refrigerant gas is heavier than air and replaces oxygen. A massive leak could lead to oxygen depletion, especially in basements, and an asphyxiation hazard could occur leading to serious injury or death.
- If the refrigerant gas leaks during installation, ventilate the area immediately.

Refrigerant gas may produce a toxic gas if it comes in contact with fire such as from a fan heater, stove or cooking device.
Exposure to this gas could cause severe injury or death.

- After completing the installation work, check that the refrigerant gas does not leak.
Refrigerant gas may produce a toxic gas if it comes in contact with fire such as from a fan heater, stove or cooking device.
Exposure to this gas could cause severe injury or death.
- Do not ground units to water pipes, telephone wires or lightning rods because incomplete grounding could cause a severe shock hazard resulting in severe injury or death, and to gas pipes because a gas leak could result in an explosion which could lead to severe injury or death.
- Safely dispose of the packing materials.
Packing materials, such as nails and other metal or wooden parts, may cause stabs or other injuries.
Tear apart and throw away plastic packaging bags so that children will not play with them.
Children playing with plastic bags face the danger of death by suffocation.
- Do not install unit in an area where flammable materials are present due to risk of explosion resulting in serious injury or death.
- Do not ground units to telephone wires or lightning rods because lightning strikes could cause a severe shock hazard resulting in severe injury or death, and to gas pipes because a gas leak could result in an explosion which could lead to severe injury or death.

WARNING

- Installation shall be left to the authorized dealer or another trained professional.
Improper installation may cause water leakage, electrical shock, fire, or equipment damage.
- Install the air conditioner according to the instructions given in this manual.
Incomplete installation may cause water leakage, electrical shock, fire or equipment damage.
- Be sure to use the supplied or exact specified installation parts.
Use of other parts may cause the unit to come to fall, water leakage, electrical shock, fire or equipment damage.
- Install the air conditioner on a solid base that is level and can support the weight of the unit.
An inadequate base or incomplete installation may cause injury or equipment damage in the event the unit falls off the base or comes loose.
- Electrical work shall be carried out in accordance with the installation manual and the national, state and local electrical wiring codes.
Insufficient capacity or incomplete electrical work may cause electrical shock, fire or equipment damage.
- Be sure to use a dedicated power circuit. Never use a power supply shared by another appliance.
Follow all appropriate electrical codes.
- For wiring, use a wire or cable long enough to cover the entire distance with no splices if possible.
Do not use an extension cord. Do not put other loads on the power supply.
Use only a separate dedicated power circuit.
(Failure to do so may cause abnormal heat, electric shock, fire or equipment damage.)
- Use the specified types of wires for electrical connections between the indoor and outdoor units.
Follow all state and local electrical codes.
Firmly clamp the inter-unit wire so their terminals receive no external stresses.
Incomplete connections or clamping may cause terminal overheating, fire or equipment damage.
- After connecting all wires be sure to shape the cables so that they do not put undue stress on the electrical covers, panels or terminals.
Install covers over the wires. Incomplete cover installation may cause terminal overheating, electrical shock, fire or equipment damage.
- When installing or relocating the system, be sure to keep the refrigerant circuit free from all substances other than the specified refrigerant (R410A), such as air.
(Any presence of air or other foreign substance in the refrigerant circuit causes an abnormal pressure rise which may result in rupture, resulting in injury.)
- During pump down, stop the compressor before removing the refrigerant piping.
If the compressor is still running and the stop valve is open during pump down, air will be sucked in when the refrigerant piping is removed, causing abnormally high

pressure which could lead to equipment damage or and personal injury.





- During installation, attach the refrigerant piping securely before running the compressor.
If the refrigerant pipes are not attached and the stop valve is open during installation, air will be sucked in when the compressor is run, causing abnormally high pressure which could lead to equipment damage and personal injury.
- Be sure to install a ground fault circuit interrupter.
Failure to install a ground fault circuit interrupter may result in electrically shocks, or fire personal injury.

CAUTION

- Do not install the air conditioner where gas leakage would be exposed to open flames.
If the gas leaks and builds up around the unit, it may catch fire.
- Establish drain piping according to the instructions of this manual.
Inadequate piping may cause water damage.
- Tighten the flare nut according to the specified torque. A torque wrench should be used.
If the flare nut is tightened too much, the flare nut may crack over time and cause refrigerant leakage.
- Do not touch the heat exchanger fins.
Improper handling may result in injury.
- Be very careful about product transportation.
Some products use PP bands for packaging. Do not use any PP bands for a means of transportation. It is dangerous.
- Make sure to provide for adequate measures in order to prevent that the outdoor unit be used as a shelter by small animals.
Small animals making contact with electrical parts can cause malfunctions, smoke or fire. Please instruct the customer to keep the area around the unit clean.
- The temperature of refrigerant circuit will be high, please keep the inter-unit wire away from copper pipes that are not thermally insulated.
- Electrical work must be performed in accordance with the NEC/CEC by authorized personnel only.

Accessories

Accessories supplied with the outdoor unit:

(A) Installation manual 		1	(B) Drain socket*  It is on the bottom packing case.		1
(C) Drain cap (1)* 	09/12 class	4	(D) Drain cap (2)* 	09/12 class	2
	18/24 class	6		18/24 class	3

*Only for heat pump models.

Precautions for Selecting the Location

- 1) Choose a place solid enough to bear the weight and vibration of the unit, where the operating sound will not be amplified.
- 2) Choose a location where the hot air discharged from the unit or the operating sound will not cause a nuisance to the neighbours of the user.
- 3) Avoid places near a bedroom and the like, so that the operating sound will cause no trouble.
- 4) There must be sufficient spaces for carrying the unit into and out of the site.
- 5) There must be sufficient space for air passage and no obstructions around the air inlet and the air outlet.
- 6) The site must be free from the possibility of flammable gas leakage in a nearby place.
- 7) Install units, power cords and inter-unit wire at least 10ft (3m) away from television and radio sets. (This is to prevent interference to images and sounds. Noise may be experienced even if they are more than 10ft (3m) away depending on radio wave conditions.)
- 8) In coastal areas or other places with a salty atmosphere or one containing sulphate gas, corrosion may shorten the life of the air conditioner.
- 9) Since water will flow from the drain of the outdoor unit, do not place under the unit anything which must be kept away from moisture.

NOTE

Cannot be installed suspended from ceiling or stacked.

⚠ CAUTION

When operating the air conditioner in a low outdoor ambient temperature, be sure to follow the instructions described below.

- To prevent exposure to wind, install the outdoor unit with its suction side facing the wall.
- Never install the outdoor unit at a site where the suction side may be exposed directly to wind.
- To prevent exposure to wind, it is recommended to install a baffle plate on the air discharge side of the outdoor unit.
- In heavy snowfall areas, select an installation site where the snow will not affect the unit.

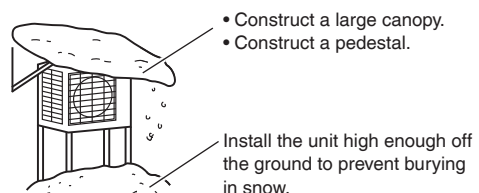

Precautions on Installation

- Check the strength and level of the installation surface so that the unit does not cause any operating vibration or noise after installation.
- In accordance with the foundation drawing, fix the unit securely by means of the foundation bolts. (Prepare 4 sets of M8 or M10 foundation bolts, nuts and washers; all separately available.)
- It is best to screw in the foundation bolts until their ends are 3/4 inch (20mm) from the foundation surface.

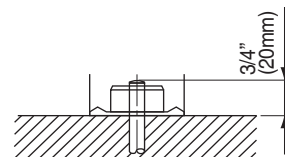

Outdoor Unit Installation Drawings

	RX09/12* RK09/12*	RXN09/12* RKN09/12*	RX18*, RXN18* RK18*, RKN18*	RX24*, RXN24* RK24*, RKN24*
Max. allowable piping length	65-5/8ft (20m)	49-1/4ft (15m)	98-1/2ft (30m)	
** Min. allowable piping length	10ft (3m)			
Max. allowable piping height	49-1/4ft (15m)	39-3/8ft (12m)	65-5/8ft (20m)	
* Additional refrigerant required for refrigerant pipe exceeding 32.8ft (10m) in length.	0.21oz/ft (20g/m)			
Gas pipe	O.D. 3/8 inch (9.5mm)	O.D. 1/2 inch (12.7mm)	O.D. 5/8 inch (15.9mm)	
Liquid pipe	O.D. 1/4 inch (6.4mm)			

*Be sure to add the proper amount of additional refrigerant. Failure to do so may result in reduced performance.
 **The suggested shortest pipe length is 10ft (3m), in order to avoid noise from the outdoor unit and vibration.
 (Mechanical noise and vibration may occur depending on how the unit is installed and the environment in which it is used.)

Wrap the insulation pipe with finishing tape from bottom to top.

CAUTION
 Keep the piping length between 10ft (3m) and 65-5/8ft (20m) (for RX09/12, RK09/12), 10ft (3m) and 49-1/4ft (15m) (for RXN09/12, RKN09/12), 10ft (3m) and 98-1/2ft (30m) (for 18/24 class).

	X	Y	Z
09/12 class	18-1/2 inch (470mm)	12-1/8 inch (308mm)	3-13/16 inch (97mm)
18/24 class	23-5/8 inch (600mm)	13-5/8 inch (346mm)	4-15/16 inch (125mm)

Allow 11-13/16" (300mm) of work space below the ceiling surface.

Stop valve cover
■ How to remove the stop valve cover
 1) Remove the screw on the stop valve cover.
 2) Slide the stop valve cover downward to remove it.
■ How to attach the stop valve cover
 1) Insert the upper part of the stop valve cover into the outdoor unit.
 2) Tighten the screw.

In sites with poor drainage, use block bases for the outdoor unit. Adjust foot height until the unit is level. Otherwise, water leakage or pooling of water may occur.

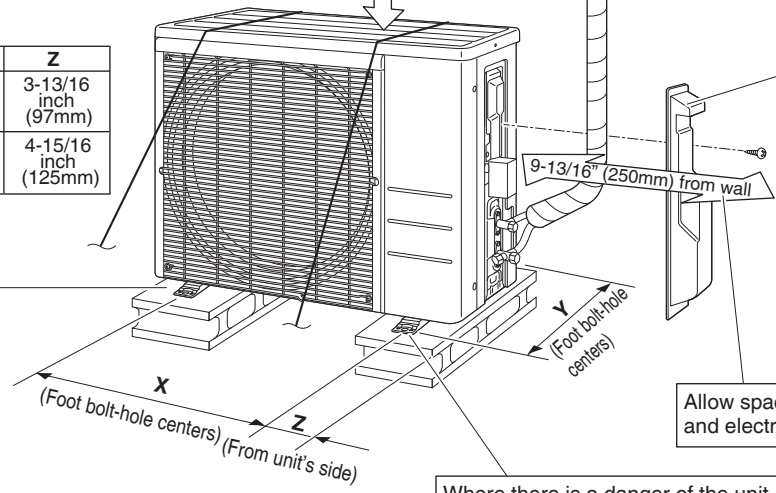

Allow space for piping and electrical servicing.

Appearance of outdoor units may differ from some models.

Installation Guidelines

- Where a wall or other obstacle is in the path of the outdoor unit's intake or exhaust airflow, follow the installation guidelines below.
- For any of the below installation patterns, the wall height on the outlet side should be 47-1/4 inch (1200mm) or less.

09/12 class

Wall facing one side

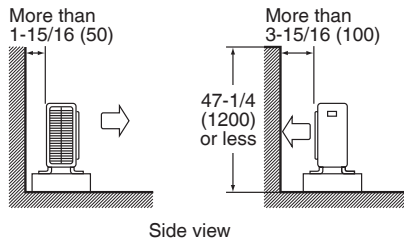

Walls facing two sides

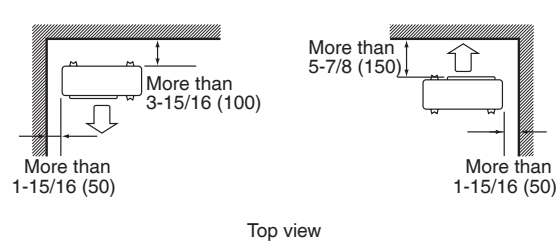

Walls facing three sides

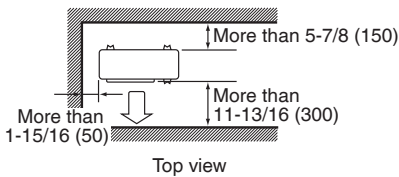

unit: inch (mm)

18/24 class

Wall facing one side

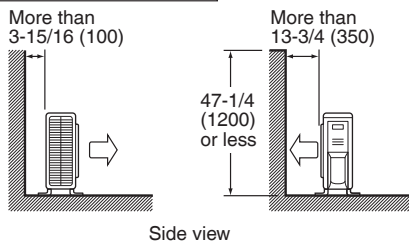

Walls facing two sides

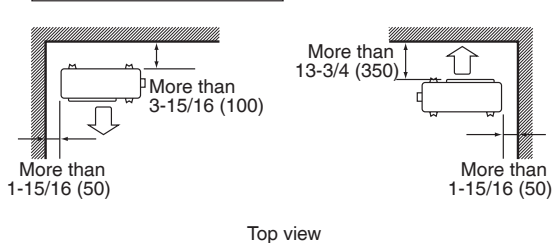

Walls facing three sides

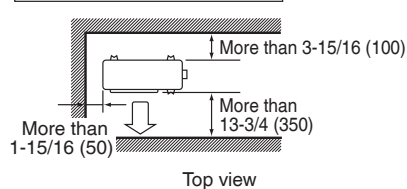

unit: inch (mm)

Outdoor Unit Installation

1. Installing the outdoor unit

- 1) When installing the outdoor unit, refer to "Precautions for Selecting the Location" and the "Outdoor Unit Installation Drawings".
- 2) If drain work is necessary, follow the procedures below.

2. Drain work (only for heat pump models)

- If the drain port is covered by a mounting base or floor surface, place additional foot bases of at least 1-1/4 inch (30mm) in height under the outdoor unit's feet.
- In cold areas, do not use a drain socket, drain caps (1,2) and a drain hose with the outdoor unit. (Otherwise, the drain water may freeze, impairing heating performance.)

- 1) Attach ③ Drain cap (1) and ④ Drain cap (2).
- 2) Attach ② Drain socket.

09/12 class

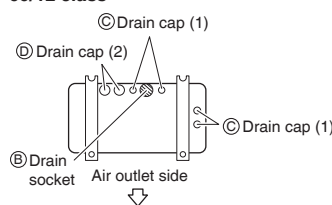

18/24 class

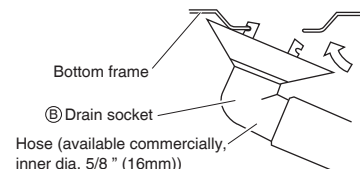
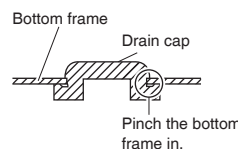
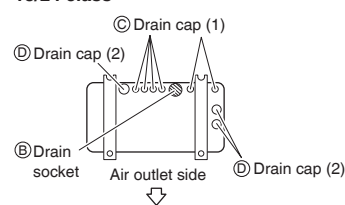

3. Flaring the pipe end

- 1) Cut the pipe end with a pipe cutter.
- 2) Remove burrs with the cut surface facing downward so that the chips do not enter the pipe.
- 3) Put the flare nut on the pipe.
- 4) Flare the pipe.
- 5) Check that the flaring is properly made.

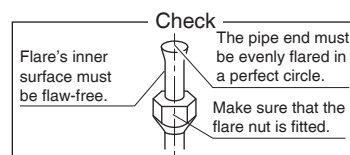
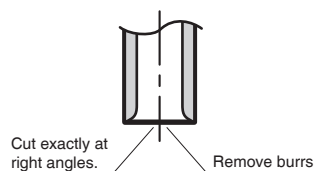

Flaring			
Set exactly at the position shown below.			
	Flare tool for R410A		Conventional flare tool
	Clutch-type	Clutch-type (Rigid-type)	Wing-nut type (Imperial-type)
A	0-0.020 inch (0-0.5mm)	0.039-0.059 inch (1.0-1.5mm)	0.059-0.079 inch (1.5-2.0mm)

⚠ WARNING

- Do not use mineral oil on flared part.
- Prevent mineral oil from getting into the system as this would reduce the lifetime of the units.
- Never use piping which has been used for previous installations. Only use parts which are delivered with the unit.
- Never install a drier to this R410A unit in order to guarantee its lifetime.
- The drying material may dissolve and damage the system.
- Incomplete flaring may cause refrigerant gas leakage.

4. Refrigerant piping

⚠ CAUTION

- Use the flare nut fixed to the main unit. (This is to prevent cracking of the flare nut as a result of deterioration over time.)
- To prevent gas leakage, apply refrigeration oil only to the inner surface of the flare. (Use refrigeration oil for R410A.)
- Use a torque wrench when tightening the flare nuts to prevent damage to the flare nuts and gas leakage.

- Align the centers of both flares and tighten the flare nuts 3 or 4 turns by hand. Then tighten them fully with a spanner and a torque wrench.

Flare nut tightening torque				
Gas side			Liquid side	
3/8 inch (9.5mm)	1/2 inch (12.7mm)	5/8 inch (15.9mm)	1/4 inch (6.4mm)	
24-1/8 - 29-1/2ft • lbf (32.7-39.9N • m)	36-1/2 - 44-1/2ft • lbf (49.5-60.3N • m)	45-5/8 - 55-5/8ft • lbf (61.8-75.4N • m)	10-1/2 - 12-3/4ft • lbf (14.2-17.2 N • m)	
Width across flats	11/16 inch (17mm)	3/4 inch (19mm)	7/8 inch (22mm)	1-1/16 inch (27mm)
Valve cap tightening torque	10-1/2 - 12-5/8ft • lbf (14.2-17.2N • m)	12-5/8 - 15-3/8ft • lbf (17.1-20.9N • m)	16 - 20-1/4ft • lbf (21.6-27.4N • m)	35-3/8 - 44-1/8ft • lbf (48-59.8N • m)
Service port cap tightening torque				
8 - 10-7/8ft • lbf (10.8-14.7N • m)				

Apply oil

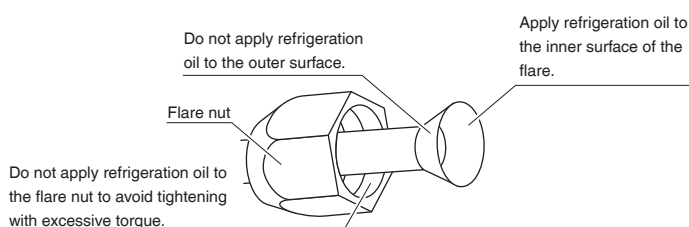

Outdoor Unit Installation

5. Pressure test and evacuating system

⚠ WARNING

- Do not mix any substance other than the specified refrigerant (R410A) into the refrigeration cycle.
- If refrigerant gas leaks should occur, ventilate the room as soon and as much as possible.
- R410A, as well as other refrigerants, should always be recovered and never be released directly into the environment.
- Use a vacuum pump for R410A exclusively. Using the same vacuum pump for different refrigerants may damage the vacuum pump or the unit.

- When piping work is complete, it is necessary to perform a pressure test and evacuate system with a vacuum pump.
- If using additional refrigerant, perform air purging of the refrigerant pipes and indoor unit using a vacuum pump, then charge additional refrigerant.
- Use a hexagonal wrench (3/16 inch (4mm)) to operate the stop valve rod.
- All refrigerant pipe joints should be tightened with a torque wrench to the specified tightening torque.

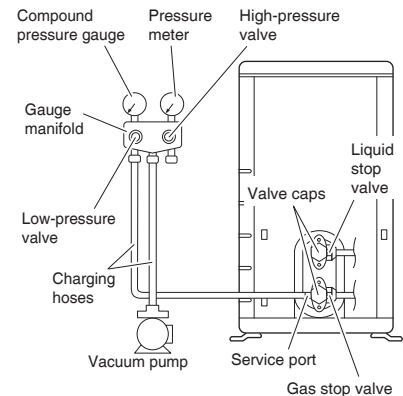

- 1) Pressurize the liquid pipe and gas pipe from the service ports of each stop valve to 550psi (3.8MPa) (do not pressurize more than 550psi (3.8MPa)) for 1 hour minimum, 24 hours recommended. If there is a pressure drop, check for leaks, make repairs and perform the pressure test again.
- 2) Connect projection side of charging hose (which comes from gauge manifold) to gas stop valve's service port.
- 3) Fully open gauge manifold's low-pressure valve (Lo) and completely close its high-pressure valve (Hi).
(High-pressure valve subsequently requires no operation.)
- 4) Evacuate system using vacuum pump to below 500 microns for 1 hour minimum.
- 5) Close gauge manifold's low-pressure valve (Lo) and stop vacuum pump.
(Keep this state for a few minutes to make sure that the compound pressure gauge pointer does not swing back.)*¹
- 6) Remove covers from liquid stop valve and gas stop valve.
- 7) Turn the liquid stop valve's rod 90° counter-clockwise with a hexagonal wrench to open the valve.
Close it after 5 seconds, and check for gas leakage.
Using soapy water, check for gas leakage from indoor unit's flare and outdoor unit's flare and valve rods.
After the check is complete, wipe all soapy water off.
- 8) Disconnect charging hose from gas stop valve's service port, then fully open liquid and gas stop valves.
(Do not attempt to turn valve rod beyond its stop.)
- 9) Tighten valve caps and service port caps for the liquid and gas stop valves with a torque wrench to the specified torques.

*¹ If the compound pressure gauge pointer swings back, refrigerant may have water content or a loose pipe joint may exist. Check all pipe joints and retighten nuts as needed, then repeat steps 3) through 5).

6. Refilling refrigerant

Check the type of refrigerant to be used on the machine nameplate.

Precautions when adding R410A

Fill from the liquid pipe in liquid form.

This is a mixed refrigerant, so adding it in gas form may cause the refrigerant composition to change, preventing normal operation.

- 1) Before filling, check whether the cylinder has a siphon attached or not. (It should have something like "liquid filling siphon attached" displayed on it.)

Filling a cylinder with an attached siphon



Stand the cylinder upright when filling.

(There is a siphon pipe inside, so the cylinder need not be upside-down to fill with liquid.)

Filling other cylinders



Turn the cylinder upside-down when filling.

- Be sure to use the R410A tools to ensure pressure and to prevent foreign objects entering.

7. Refrigerant piping work

7-1. Cautions on pipe handling

- Protect the open end of the pipe against dust and moisture.
- All pipe bends should be as gentle as possible. Use a pipe bender for bending.

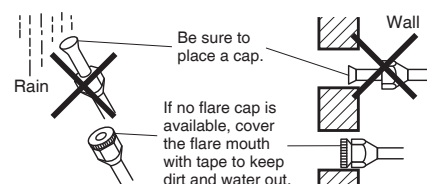

7-2. Selection of copper and heat insulation materials

When using commercial copper pipes and fittings, observe the following:

- Insulation material: Polyethylene foam
Heat transfer rate: 0.041 to 0.052W/mK (0.024 to 0.030Btu/ft^h°F (0.035 to 0.045kcal/mh°C))
Be sure to use insulation that is designed for use with HVAC Systems.
- ACR Copper only.
- Be sure to insulate both the gas and liquid piping and observe the insulation dimensions as below.

	Piping size	Minimum bend radius	Piping thickness	Thermal insulation size	Thermal insulation thickness
Gas side	O.D. 3/8 inch (9.5mm)	1-3/16 inch (30mm) or more	0.031 inch (0.8mm) (C1220T-O)	I.D. 15/32-19/32 inch (12-15mm)	13/32 inch (10mm) Min.
	O.D. 1/2 inch (12.7mm)	1-9/16 inch (40mm) or more		I.D. 9/16-5/8 inch (14-16mm)	
	O.D. 5/8 inch (15.9mm)	1-15/16 inch (50mm) or more	0.039 inch (1.0mm) (C1220T-O)	I.D. 5/8-13/16 inch (16-20mm)	
Liquid side	O.D. 1/4 inch (6.4mm)	1-3/16 inch (30mm) or more	0.031 inch (0.8mm) (C1220T-O)	I.D. 5/16-13/32 inch (8-10mm)	

- Use separate thermal insulation pipes for gas and liquid refrigerant pipes.

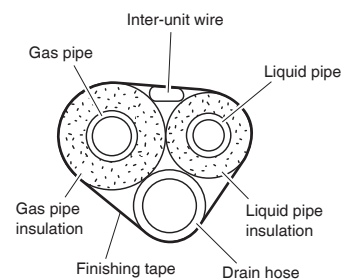

Wiring

⚠ WARNING

- Do not use tapped wires, extension cords, or starburst connections, as they may cause overheating, electrical shock, or fire.
- Do not use locally purchased electrical parts inside the product. (Do not branch the power for the drain pump, etc., from the terminal block.) Doing so may cause electric shock or fire.
- Be sure to install a ground fault circuit interrupter. (One that can handle higher harmonics.)
(This unit uses an inverter, which means that a ground fault circuit interrupter capable of handling harmonics must be used in order to prevent any malfunction of the ground fault circuit interrupter itself.)
- Use an all-pole disconnection type circuit breaker with at least 1/8 inch (3mm) between the contact point gaps.
- When carrying out wiring connection, take care not to pull at the conduit.
- Do not connect the power wire to the indoor unit. Doing so may cause electric shock or fire.

- Do not turn on the circuit breaker until all work is completed.
 - 1) Strip the insulation from the wire (3/4 inch (20mm)).
 - 2) Connect the inter-unit wires between the indoor and outdoor units so that the terminal numbers match. Tighten the terminal screws securely. We recommend a flathead screwdriver be used to tighten the screws. The screws are packed with the terminal block.

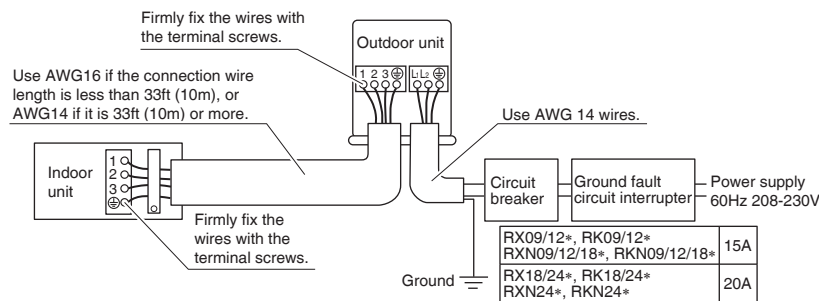

09/12 class

<Method of mounting conduit>

- A protection plate is fixed for protection from the high-voltage section.
- 1) Dismount the stop valve cover by removing the screw.
 - 2) Dismount the protection plate by removing the 2 screws.
 - 3) Dismount the conduit mounting cover by removing the 2 screws.
 - 4) Pass wires through the conduit and secure them with a lock nut.
 - 5) After completing the work, reattach the stop valve cover, the conduit mounting cover, and the protection plate to its original position.

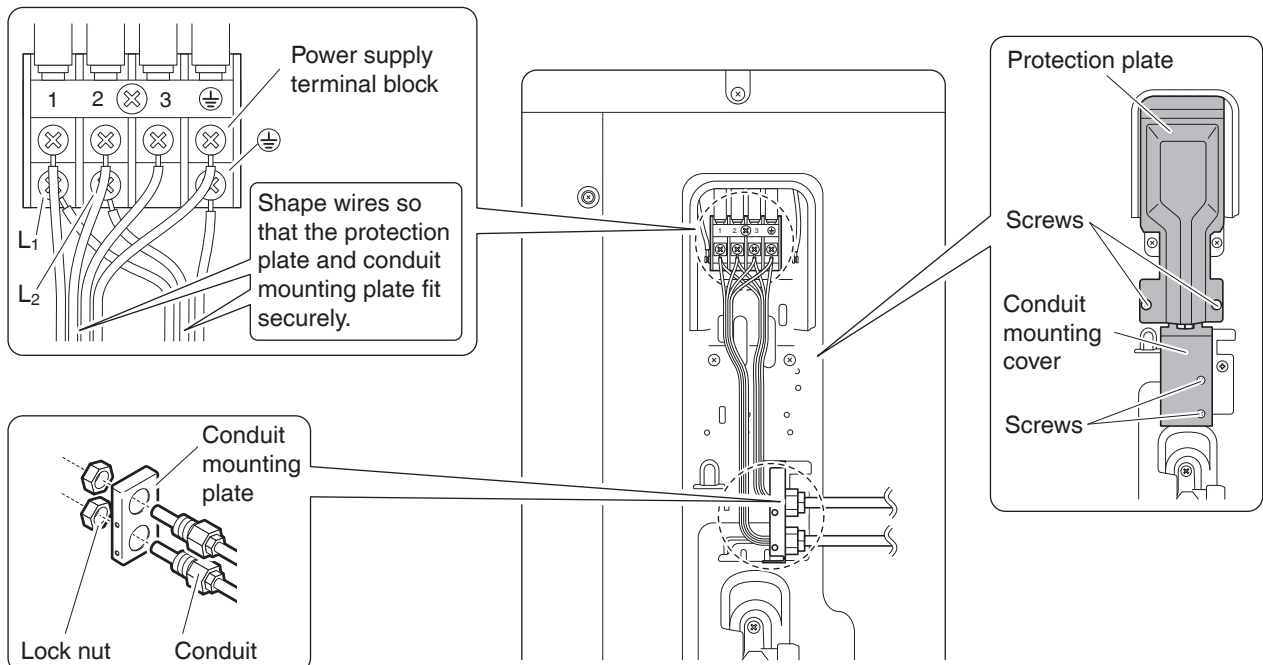

18/24 class

<Method of mounting conduit>

- 1) Dismount the service lid by removing the 2 screws.
- 2) Pass wires through the conduit and secure them with a lock nut.
- 3) After completing the work, reattach the service lid to its original position.

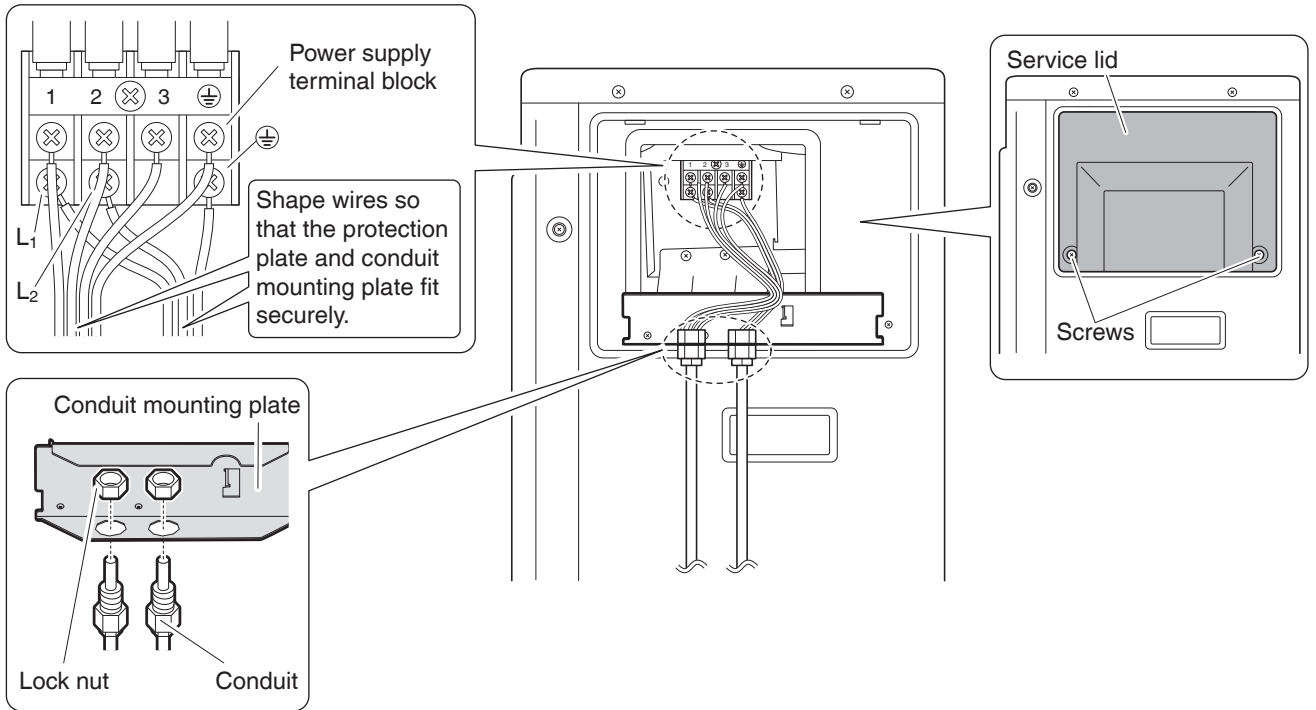

CAUTION

- Precautions to be taken for power supply wiring. When using stranded wires, make sure to use the round crimp-style terminal for connection to the power supply terminal block.

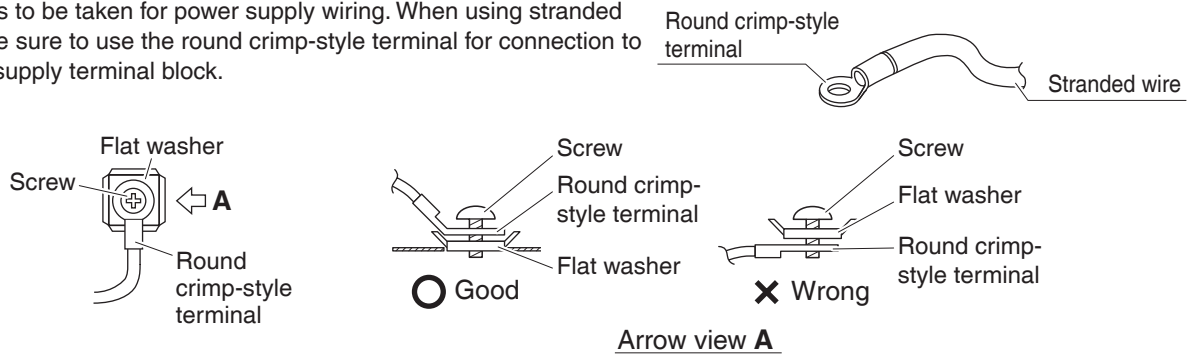

- When connecting the inter-unit wires to the terminal block using a single core wire, be sure to curl the end of the lead. Improper work may cause heat and fires.

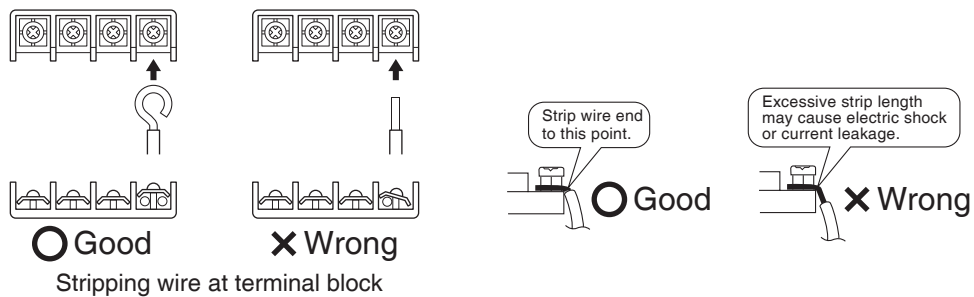

Facility Setting* (cooling at low outdoor temperature)

This function is limited only for facilities (the target of air conditioning is equipment (such as computer)).
Never use it in a residence or office (the space where there is a human).

*Only for RX and RK models.

- Cutting jumper 6 (J6) on the circuit board will expand the operation range down to 5°F (-15°C). However it will stop if the outdoor temperature drops below -4°F (-20°C) and start back up once the temperature rises again.

- 1) Remove the top plate of the outdoor unit. (09/12 class: 3 screws, 18/24 class: 6 screws)
- 2) Remove the front plate. (09/12 class: 4 screws, 18/24 class: 8 screws)
- 3) Cut the jumper (J6) of the PCB inside.

⚠ CAUTION

- If the outdoor unit is installed where the heat exchanger of the unit is exposed to direct wind, provide a windbreak wall.
- Intermittent noises may be produced by the indoor unit due to the outdoor fan turning on and off when using facility settings.
- Do not place humidifiers or other items which might raise the humidity in rooms where facility settings are being used. A humidifier might cause dew jumping from the indoor unit outlet vent.
- Cutting jumper 6 (J6) sets the indoor fan tap to the highest position. Notify the user about this.

Pump Down Operation

In order to protect the environment, be sure to pump down when relocating or disposing of the unit.

- 1) Remove the valve cap from the liquid stop valve and gas stop valve.
- 2) Carry out forced cooling operation.
- 3) After 5 to 10 minutes, close the liquid stop valve with a hexagonal wrench.
- 4) After 2 to 3 minutes, close the gas stop valve and stop forced cooling operation.

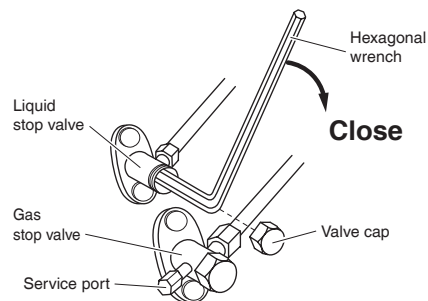

Forced cooling operation

■Using the indoor unit ON/OFF switch

Press the indoor unit ON/OFF switch for at least 5 seconds. (The operation will start.)

- Forced cooling operation will stop automatically after about 15 minutes. To stop the operation, press the indoor unit ON/OFF switch.

■Using the indoor unit's remote controller

- 1) Press **TEMP F/C**, **TEMP F/C** and **OFF** at the same time.
- 2) Press **TEMP F/C**, then select **?**, press **FAN**.
- 3) Press **COOL** to turn on the system.

- Forced cooling operation will stop automatically after about 30 minutes. To stop the operation, press **OFF**.



HEAT PUMP model

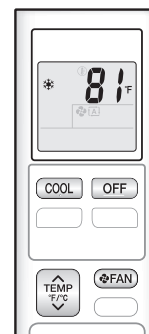

COOLING ONLY model

⚠ CAUTION

- When pressing the switch, do not touch the terminal block. It has a high voltage, and touching it could cause electric shock.
- After closing the liquid stop valve, close the gas stop valve within 3 minutes, then stop the forced operation.

Trial Operation and Testing

1. Trial operation and testing

- Trial operation should be carried out in either COOL or HEAT operation.

1-1. Measure the supply voltage and make sure that it is within the specified range.

1-2. In COOL operation, select the lowest programmable temperature; in HEAT operation, select the highest programmable temperature.



1-3. Carry out the trial operation in accordance with the operation manual to ensure that all functions and parts, such as flap movement, are working properly.

- For protection, the system disables restart operation for 3 minutes after it is turned off.

1-4. After trial operation is complete, set the temperature to a normal level (78°F to 82°F (26°C to 28°C) in COOL operation, 68°F to 75°F (20°C to 24°C) in HEAT operation).

- When operating the air conditioner in COOL operation in winter, or HEAT operation in summer, set it to the trial operation mode using the following method.

1) Press ,  and  at the same time.

2) Press , then select .

3) Press  or  to turn on the system.

- Trial operation will stop automatically after about 30 minutes. To stop the operation, press .
- Some of the functions cannot be used in the trial operation mode.

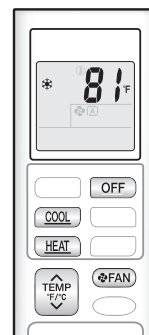

HEAT PUMP model

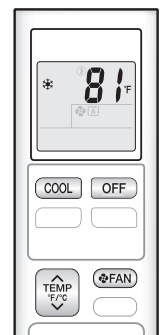

COOLING ONLY model

- The air conditioner draws a small amount of power in its standby mode. If the system is not to be used for some time after installation, shut off the circuit breaker to eliminate unnecessary power consumption.
- If the circuit breaker trips to shut off the power to the air conditioner, the system will restore the original operation mode when the circuit breaker is opened again.

2. Test items

Test items	Symptom	Check
Indoor and outdoor units are installed properly on solid bases.	Fall, vibration, noise	
No refrigerant gas leaks.	Incomplete cooling/heating function	
Refrigerant gas and liquid pipes and indoor drain hose extension are thermally insulated.	Water leakage	
Draining line is properly installed.	Water leakage	
System is properly grounded.	Electrical leakage	
The specified wires are used for inter-unit wiring.	No operation or burn damage	
Indoor or outdoor unit's air inlet or air outlet are unobstructed.	Incomplete cooling/heating function	
Stop valves are opened.	Incomplete cooling/heating function	
Indoor unit properly receives remote control commands.	No operation	