Comfort-Cire®

Century®

IOM & Owner's Manual

VFH-B Series

Inverter Multi Zone Ductless Mini-Split

A-VFH18DB-1

A-VFH24TB-1



www.marsdelivers.com

In line with the MARS policy of continual product improvement, the aesthetic and dimensional characteristics, technical data and accessories of this appliance may be changed without notice.

CONTENTS

GENERAL INFORMATION

GENERAL INFORMATION	Conformity And Range	1
	The Instructions Before Use	2
	Name of Parts	3
	Technical Data	4
	Outdoor Unit Working Temperature Range	4
INSTALLER	Electrical Connections	5
	Installing The Outdoor Unit	6
	Evacuation	6
	Maintenance	7
	Installation Dimension Diagram	7
	Check After Installation	8

The products in this manual may be different the actual product please refer to the your equipment .

This appliance is not intended for use by persons (including children) with reduced physical, sensory or mental capabilities, or lack of experience and knowledge, unless they have been given supervision or instruction concerning use of the appliance by a person responsible for their safety.

Children should be supervised to ensure that they do not play with the appliance.

Explanation of Symbols



Indicates a hazardous situation that, if not avoided, will result in death or serious injury.



Indicates a hazardous situation that, if not avoided, could result in death or serious injury.



Indicates a hazardous situation that, if not avoided, may result in minor or moderate injury.

NOTICE

Indicates important but not hazard-related information, used to indicate risk of property damage.



Indicates a hazard that would be assigned a signal word WARNING or CAUTION.

CONFORMITY AND RANGE

GENERAL INFORMATION

This appliance can be used by children aged 8 years and above and persons with reduced physical, sensory or mental capabilities or lack of experience and knowledge if they have been given supervision or instruction concerning use of the appliance in a safe way and understand the hazards involved.

Children should not play with the appliance.

Cleaning and user maintenance shall not be performed by children without supervision.

 Please read this owner's manual carefully before operating the unit and keep it for reference. Instructions for installation and use of this product are provided by the manufacturer.

 Only use the air conditioner as instructed in this booklet. These instructions are not intended to cover every possible condition and situation. As with any electrical household appliance, common sense and caution are therefore always recommended for installation, operation and maintenance.

THE INSTRUCTIONS BEFORE USE

GENERAL INFORMATION

WARNING

★ If you have a burning smell or smoke, please turn off the power supply and contact your service center.

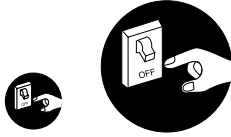

The unit may be damaged, and may cause electric shock or fire.

★ This unit must match the circuit breaker to assure it has enough capacity. The unit will be turned on or off according to your requirement automatically, please do not turn on or turn off the unit frequently, this could damage the unit.

★ Never cut off or damage power cables and control wires. If the power cable and signal control wire are damaged, replacement must be performed by professional.



★ Power must match the circuit to prevent fire.

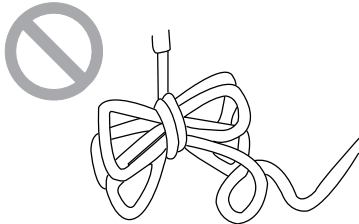

Otherwise, it can cause electric shock or fire.

★ Disconnect the power supply if taking the air conditioner out of use.



Otherwise, the accumulated dust may cause overheating or fire.

★ Never damage the electric wire or use the electric wire which is not sized and matched appropriately.



Otherwise, it will cause overheating or fire.

★ When cleaning, it is necessary to turn unit off and disconnect the power supply.

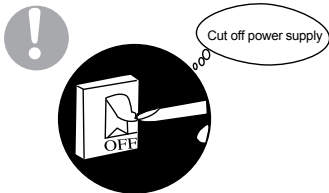

Otherwise, it may cause electric shock or damage.

★ Rated voltage of this air conditioner is 208/230V, 60Hz. The compressor will vibrate sharply if the voltage is too low, or too high. Electrical components are easy to damage if the voltage is too high.

★ Don't attempt to repair the air conditioner by yourself.

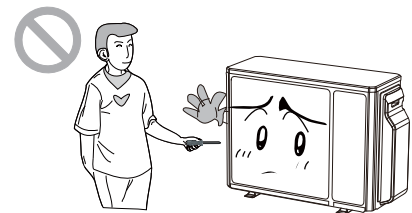

The wrong repair will lead to an electric shock or fire. You should contact your service center to repair.

★ Please insure that the installed stand is strong enough.

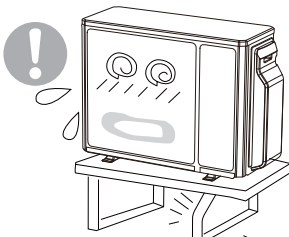

If it is damaged, it may lead to the unit falling and cause injury and damage.

★ Don't step on the top of the outdoor unit or place anything on it.

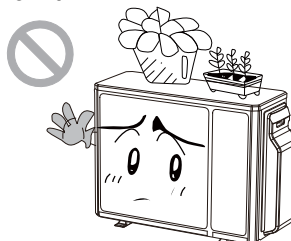

★ Grounding: The unit must be reliably grounded. The grounding cable shall be connected to the special grounding device in the construction.



NAME OF PARTS **GENERAL INFORMATION**

A_VFH18DB-1

WARNING

- Be sure to cut off the power supply before cleaning the air conditioner; otherwise electric shock may happen.
- Spraying your air conditioner with water may cause the risk of electric shock. Make sure not to use a hose on your air conditioner.
- Volatile liquids such as thinner or gasoline will cause damage to the appearance of air conditioner. (Only use soft dry cloth or moist cloth to clean the air conditioner cabinet).
- This product must not be disposed together with the domestic waste.
This product has to be disposed at an authorized facility for recycling of electrical and electronic appliances.
- The temperature of refrigerant circuit will be high, please keep the interconnection cable away from the copper tube.



OUTDOOR UNIT	
No.	Description
1	Air outlet grille
2	Valve

Note: The above figures are only intended as a simple diagram of the appliance and may not correspond to the appearance of the units that have been purchased.

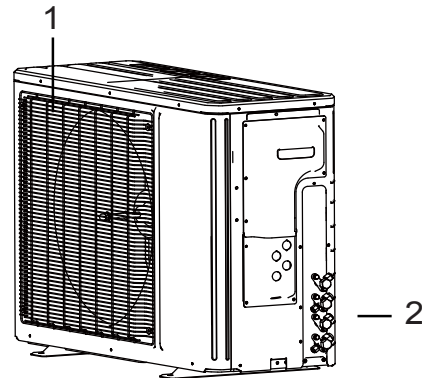

A-VFH24TB-1

WARNING

- If the supply cord is damaged, it must be replaced by the service agent or a similarly qualified person in order to avoid a hazard.
- Be sure to cut off the power supply before cleaning the air conditioner; otherwise electric shock may happen.
- Spraying your air conditioner with water may cause the risk of electric shock. Make sure not to use a hose on your air conditioner.
- Volatile liquids such as thinner or gasoline will cause damage to the appearance of air conditioner. (Only use soft dry cloth moist cloth clean the air conditioner cabinet).
- Do not dispose this product as unsorted municipal waste. Collection of such waste separately for special treatment is necessary.
- The temperature of refrigerant circuit will be high, please keep the interconnection cable away from the copper tube.

OUTDOOR UNIT	
No.	Description
1	Air outlet grille
2	Valve

Note: The above figures are only intended to be a simple diagram of the appliance and may not correspond to the appearance of the units that have been purchased.

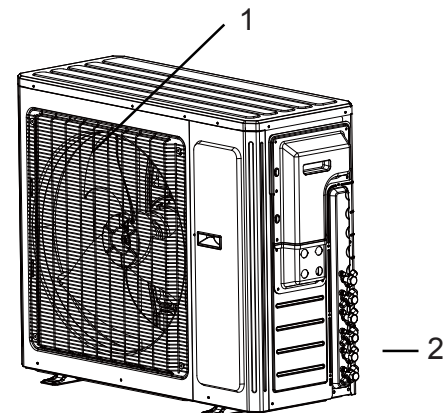

TECHNICAL DATA	GENERAL INFORMATION
-----------------------	----------------------------

MODE	A_VFH18DB-1		
Electrical data			
Electricity supply	208/230V,60HZ		
Fuse or air switch	25		
Minimum power cord section	2.1		mm ²
Size and clearance			
	L	35	in
	P	14-1/4	in
	H	27-1/2	in

TECHNICAL DATA	GENERAL INFORMATION
-----------------------	----------------------------

MODE	A-VFH24TB-1		
Electrical data			
Electricity supply	208/230V,60HZ		
Fuse or air switch	30		
Minimum power cord section	3.3		mm ²
Size and clearance			
	L	36-1/4	in
	P	15	in
	H	31-1/8	in

OUTDOOR UNIT WORKING TEMPERATURE RANGE	GENERAL INFORMATION
---	----------------------------

	OutdoorsideDB/WB(°C)
Maximum cooling	48(118.4°F)-
Maximum heating	27(80.6°F)-

ELECTRICAL CONNECTIONS **INSTALLER**

A-VFH18DB-1
A-VFH24TB-1

1. Remove the handle at the right side plate of the outdoor unit (one screw).
2. Remove the cable clamp, connect the power connection cable with the terminal at the row of connection and affix the connection. The fitting line distributing must be consistent with the indoor unit. Wiring should match that of indoor unit.
3. Affix power connection wire by wire clamp.
4. Ensure wire has been firmly attached.
5. Install the handle.

! Including a circuit breaker with suitable capacity, please note the following table. Circuit breaker should include thermal overload, it can protect the circuit-short and overload. (Caution: please do not use fuse only to protect the circuit)

Air-conditioner	Circuit breaker capacity
A-VFH18DB-1	25A
A-VFH24TB-1	30A

- !** An all-pole disconnection switch having a contact separation of at least 3mm in all pole should be connected in fixed wiring.
- !** Wrong wire connection may cause malfunction or damage to some electric components. After attaching cable, ensure that leads between connection to fixed point have some space.
- !** The connection pipes and the connecting wires of the unit A and unit B must correspond to each other.
- !** The appliance shall be installed in accordance with national wiring regulations.

Note: the above figures are only intended to be a simple diagram of the appliance and may not correspond to the appearance of the units that have been purchased.

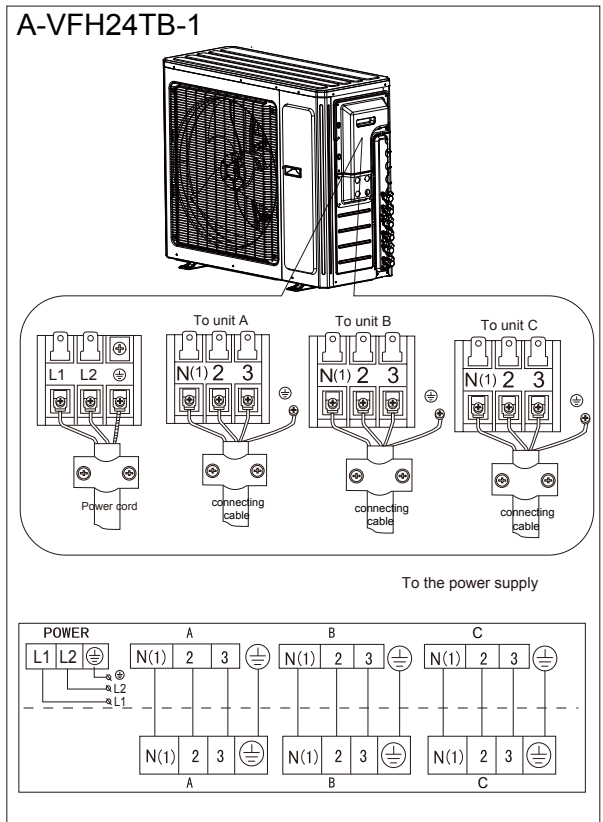
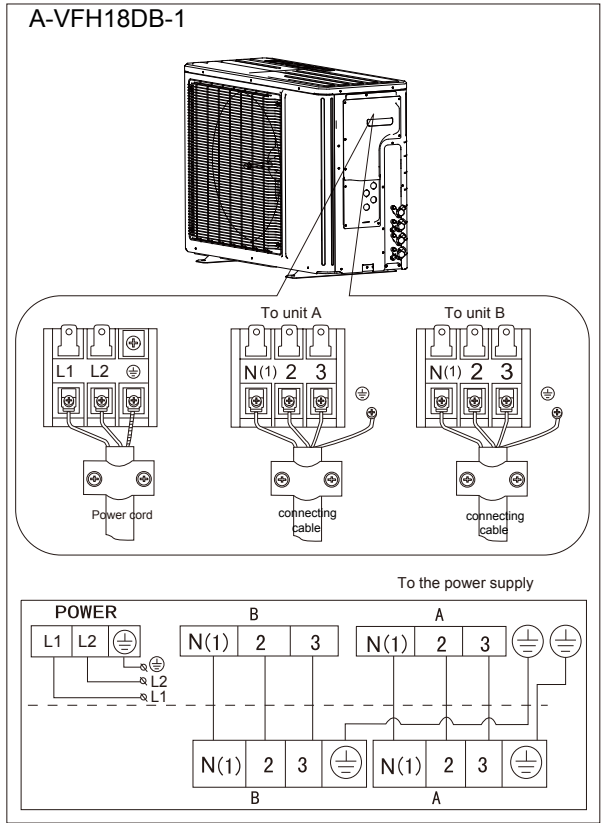

INSTALLING THE OUTDOOR UNIT
INSTALLER
Location

- ⚠ Use bolts to secure the unit to a flat, solid floor. When mounting the unit on a wall or the roof, make sure the support is firmly secured so that it cannot move in the event of intense vibrations or a strong wind.

- Do not install the outdoor unit in pits or air vents

Installing the pipes

- ⚠ Use suitable connecting pipes and equipment for the refrigerant R410A.

Models(m)	18Kx2	24Kx3
Max. connection pipe length	20	60
Max. connection pipe length (Simple one indoor unit)	10	20

- ⚠ The refrigerant pipes must not exceed the maximum heights 10m(18Kx2&24Kx3).
- ⚠ Wrap all the refrigerant pipes and joints.
- ⚠ Tighten the connections using two wrenches working in opposite directions.

Caution: Installation Must be Performed in Accordance with the NEC/CEC by Authorized Personnel Only.

Install the drain fitting and the drain hose (for model with heat pump only)

Condensation is produced and flows from the outdoor unit when the appliance is operating in the heating mode. In order not to disturb neighbours and to respect the environment, install a drain fitting and a drain hose to channel the condensate water. Install the drain fitting and rubber washer on the outdoor unit chassis and connect a drain hose to it as shown in the figure.

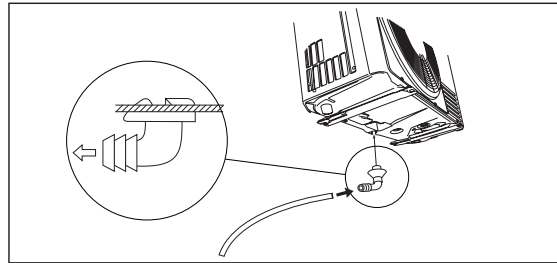

EVACUATION
INSTALLER

Humid air left inside the refrigerant circuit can cause compressor malfunction. After having connected the indoor and outdoor units, bleed the air and humidity from the refrigerant circuit using a vacuum pump.

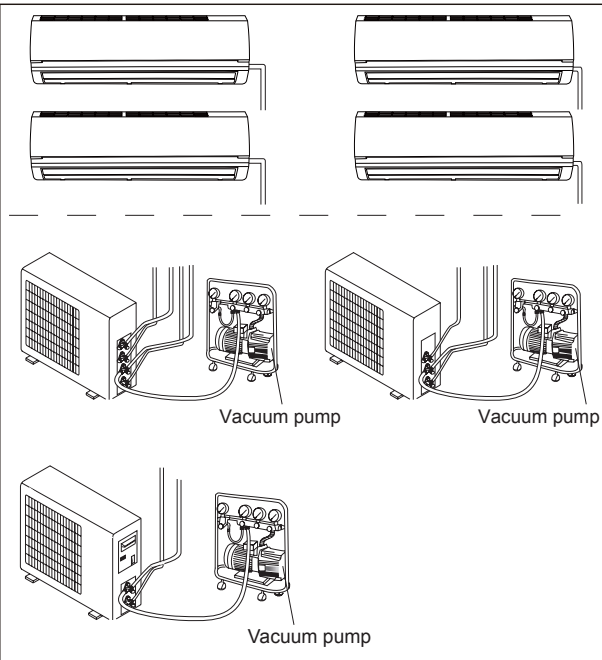
- (1) Unscrew and remove the caps from the 2-way and 3-way valves.
- (2) Unscrew and remove the cap from the service valve.
- (3) Connect the vacuum pump hose to the service valve.
- (4) Operate the vacuum pump for 10-15 minutes until an absolute vacuum of 10 mm Hg has been reached.
- (5) With the vacuum pump still in operation, close the low-pressure knob on the vacuum pump coupling. Stop the vacuum pump.
- (6) Open the 2-way valve by 1/4 turn and then close it after 10 seconds. Check all the joints for leaks using liquid soap or an electronic leak device.
- (7) Turn the body of the 2-way and 3-way valves. Disconnect the vacuum pump hose.
- (8) Replace and tighten all the caps on the valves.

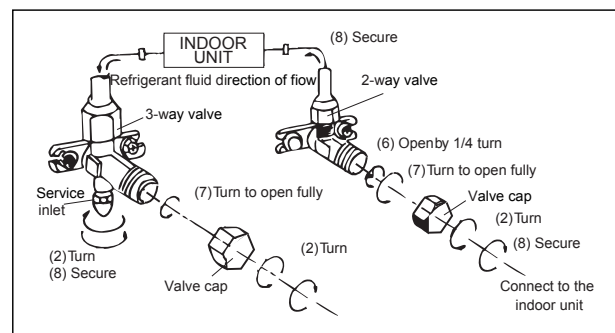
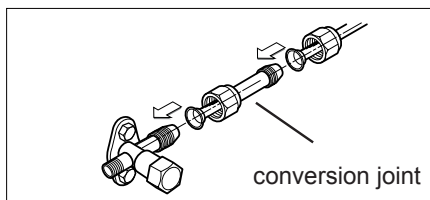

18 and 24K units use adapters that need to be installed at the indoor and outdoor units.



MAINTENANCE

INSTALLER

- ⚠ Use suitable instruments for the refrigerant R410A.
- Do not use any other refrigerant than R410A.
- ⚠ Do not use mineral oils to clean the unit.

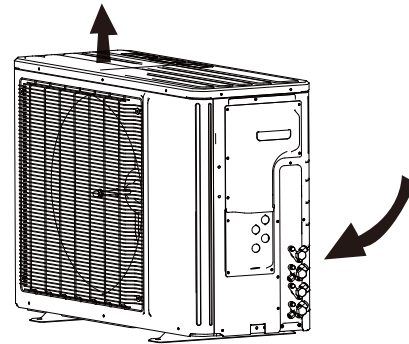

INSTALLATION DIMENSION DIAGRAM

INSTALLER

- ⚠ The installation must be done by trained and qualified service personnel with reliability according to this manual.
- ⚠ Contact service center before installation to avoid the malfunction due to unprofessional installation.
- ⚠ When picking up and moving the units, you must be guided by trained and qualified person.
- ⚠ Ensure that the recommended space is left around the appliance.

A-VFH18DB-1

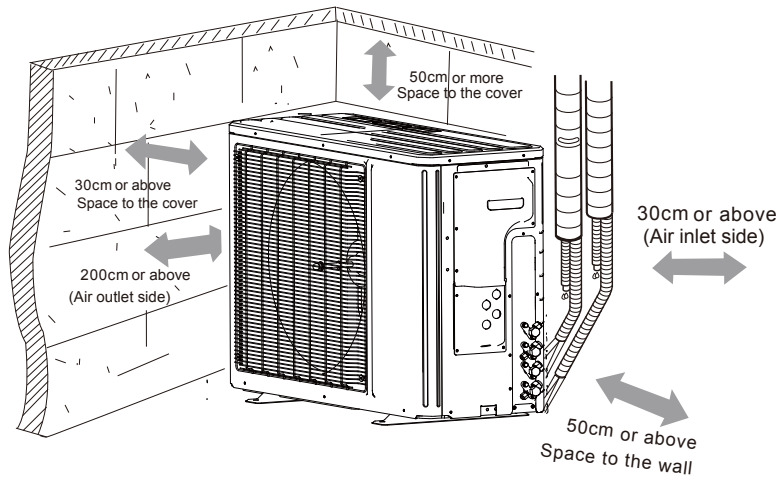

A-VFH24TB-1

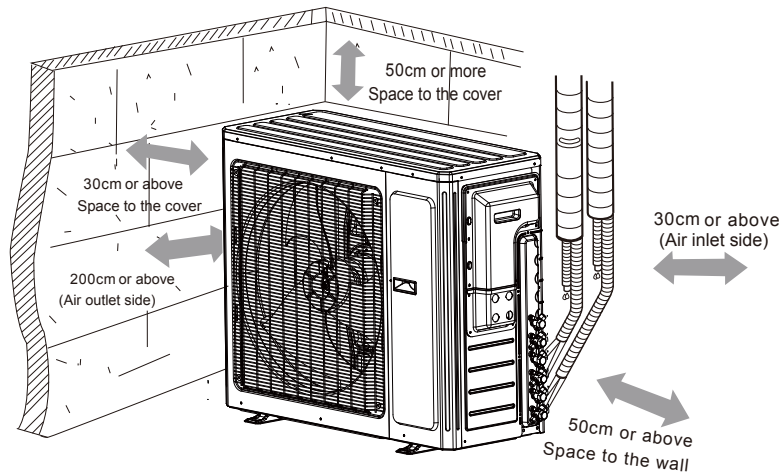

CHECK AFTER INSTALLATION
INSTALLER

Check Items	Problems Owing to Improper Installation
Is the unit firmly mounted?	The unit may drop, vibrate or make noises
Has the gas leakage been checked?	May cause unsatisfactory cooling (heating) effect or damage to compressor
Is the thermal insulation of the unit sufficient?	May cause condensation and water dripping
Is the drainage smooth?	May cause condensation and water dripping
Does the power supply voltage match the rated voltage specified on the nameplate?	The unit may break down or the components may burn out
Are the lines and pipelines correctly installed?	The unit may break down or the components may burn out
Has the unit been safely grounded?	Risk of electrical leakage
Are the models of lines in conformity with requirements?	The unit may break down or the components may burn out
Are there any obstacles near the air inlet and outlet of the indoor and outdoor units?	The unit may break down or the components may burn out
Have the length of refrigerating pipe and refrigerant charge amount been recorded?	This is a critically charged product and excess refrigerant is determined by refrigerant line length.



LIMITED EXPRESS WARRANTY

Congratulations on purchasing your new HVAC equipment. It's been designed for long life and reliable service, and is backed by one of the strongest warranties in the industry. Your unit automatically qualifies for the warranty coverage listed below, providing you keep your proof of purchase (receipt) for the equipment and meet the warranty conditions.

LIMITED ONE (2) YEAR EXPRESS WARRANTY

MARS warrants all parts of the VMH Series Ductless Mini-Split to be free from defects in workmanship and materials for normal use and maintenance for two (2) years from the date of purchase by the original consumer for the original installation. This Express Limited Warranty applies only when the Ductless Mini-Split is installed as a complete matched system: outdoor unit and indoor unit, and only when the system is installed per MARS installation instructions and in accordance with all local, state and national codes for normal use.

LIMITED 3rd to 7th YEAR EXPRESS WARRANTY

The compressor only is warranted to be free from defects in workmanship and materials for normal use and maintenance for five (5) additional years, for a total of seven (7) years from the date of purchase by the original consumer for the original installation. This Express Limited Warranty applies only when the Ductless Mini-Split is installed as a complete matched system: outdoor unit and indoor unit, and only when the system is installed per MARS installation instructions and in accordance with all local, state and national codes for normal use.

EXCEPTIONS

The Limited Express Warranty does not cover normal maintenance—MARS recommends that regular inspection/maintenance be performed at least once a season and proof of maintenance be kept. Additionally, labor charges, transportation charges for replacement parts, replacement of refrigerant or filters, any other service calls/repairs are not covered by this Limited Warranty. It also does not cover any portion or component of the system that is not supplied by MARS, regardless of the cause of failure of such portion or component.

CONDITIONS FOR WARRANTY COVERAGE

- Unit must be operated according to MARS operating instructions included with the unit and cannot have been subjected to accident, alteration, improper repair, neglect or misuse, or an act of God (such as a flood)
- Installation was done by a trained, licensed or otherwise qualified HVAC dealer/contractor
- Performance cannot be impaired by use of any product not authorized by MARS, or by any adjustments or adaptations to components
- Serial numbers and/or rating plate have not been altered or removed
- Damage has not been a result of inadequate wiring or voltage conditions, use during brown-out conditions, or circuit interruptions
- Air flow around any section of the unit has not been restricted
- Unit remains in the original installation
- Unit was not purchased over the internet

DURATION OF WARRANTY & REGISTRATION

The warranty begins on the date of purchase by the original consumer. The consumer must retain a receipted bill of sale as proof of warranty period. Without this proof, the express warranty begins on the date of shipment from the factory.

Please visit www.marsdelivers.com to register your new product

REMEDY PROVIDED BY THE LIMITED EXPRESS WARRANTY

The sole remedy under the Limited Warranty is replacement of the defective part. If replacement parts are required within the period of this warranty, MARS replacement parts shall be used; any warranty on the replacement part(s) shall not affect the applicable original unit warranty. Ready access to the unit for service is the owner's responsibility. Labor to diagnose and replace the defective part is not covered by this Limited Express Warranty. If for any reason the replacement part/product is no longer available during the warranty period, MARS shall have the right to allow a credit in the amount of the current suggested retail price of the part/product instead of providing repair or replacement.

LIMITATION OF LIABILITY

1. There are no other express or implied warranties. MARS makes no warranty of merchantability. We do not warrant that the unit is suitable for any particular purpose or can be used in buildings or rooms of any particular size or condition except as specifically provided in this document. There are no other warranties, express or implied, which extend beyond the description in this document.
2. All warranties implied by law are limited in duration to the seven-year term of the parts warranty. Your exclusive remedy is limited to the replacement of defective parts. **We will not be liable for any consequential or incidental damages caused by any defect in this unit.**
3. This warranty gives you specific legal rights and you may also have other rights which vary from state to state. Some states do not allow limitation on how long an implied warranty lasts or do not allow the exclusion or limitation of incidental or consequential damages, so the above limitations or exclusions may not apply to you.
4. No warranties are made for units sold outside the continental United States and Canada. Your distributor or final seller may provide a warranty on units sold outside these areas.
5. MARS will not be liable for damages if our performance regarding warranty resolution is delayed by events beyond our control including accident, alteration, abuse, war, government restrictions, strikes, fire, flood, or other acts of God.

HOW TO OBTAIN WARRANTY SERVICE OR PARTS

If you have a warranty claim, notify your installer promptly. If the installer does not remedy your claim, write to MARS, 1900 Wellworth Ave., Jackson MI 49203. Enclose a report of inspection by your installer or service person. Include model number, serial number, and date of purchase.

Owner responsibilities are set forth in the instruction manual—read it carefully.



KEEP THIS INFORMATION AS A RECORD OF YOUR PURCHASE	
Outdoor Unit: Model No. _____	Serial No. _____
Indoor Unit 1: Model No. _____	Serial No. _____
Indoor Unit 2: Model No. _____	Serial No. _____
Indoor Unit 3: Model No. _____	Serial No. _____
Indoor Unit 4: Model No. _____	Serial No. _____
Indoor Unit 5: Model No. _____	Serial No. _____
Date of Purchase _____	

Due to ongoing product improvements, specifications and dimensions are subject to change and correction without notice or incurring obligations. Determining the application and suitability for use of any product is the responsibility of the installer. Additionally, the installer is responsible for verifying dimensional data on the actual product prior to beginning any installation preparations.

Incentive and rebate programs have precise requirements as to product performance and certification. All products meet applicable regulations in effect on date of manufacture; however, certifications are not necessarily granted for the life of a product. Therefore, it is the responsibility of the applicant to determine whether a specific model qualifies for these incentive/rebate programs.

Comfort-Cire® 

1900 Wellworth Ave., Jackson, MI 49203 • Ph. 517-787-2100 • www.marsdelivers.com

