



BRADFORD WHITE[®]
W A T E R H E A T E R S

Condensing PV Series
Through-The-Wall Gas Water Heaters

SERVICE MANUAL

Troubleshooting Guide
and Instructions for Service

(To be performed **ONLY** by
qualified service providers)

Models Covered by This Manual:

Through-The-Wall Models:
RC2PV50H*(N,X)
LC2PV50H76*(N,X)
(* Denotes Warranty Years)



As required by the state of California Proposition 65.

The Bradford White

Condensing PV Series

Through-The-Wall Gas Water Heaters

Table of Contents

| | <u>Page</u> | <u>PV Service Procedure</u> |
|---|-------------|-----------------------------|
| Introduction | 4 | --- |
| How to Use This Manual | 5 | --- |
| Tools Required for Service | 5 | --- |
| Specifications | 6 | --- |
| Glossary of Terms | 6 | --- |
| Vent Tables | 7 | --- |
| Control Timings | 9 | --- |
| Sequence of Operation | 10 | --- |
| Troubleshooting | 14 | --- |
| Burner Inspection, Cleaning & Replacement | 16 | I |
| Pilot Inspection Testing, Cleaning & Replacement | 18 | II |
| Pressure Switch Testing & Replacement | 19 | III |
| Blower Testing & Replacement | 21 | IV |
| Blower Temperature Switch Testing & Replacement | 23 | V |
| Gas Control Testing & Replacement | 25 | VI |
| Simulated Resistive Device Testing | 29 | VII |
| Safety Circuit Voltage Trace | 30 | VIII |
| 115 VAC Circuit Trace | 31 | IX |
| Diptube Inspection & Replacement | 32 | X |
| Anode Inspection & Replacement | 33 | XI |
| Flue Baffle Inspection & Replacement | 34 | XII |
| Inner Door/Gasket Removal, Inspection & Replacement | 36 | XIII |
| Condensate Trap Removal, Inspection & Replacement | 39 | XIV |
| Exhaust Collector Removal, Inspection & Replacement | 40 | XV |
| Parts List | 42 | --- |
| Notes | 43 | --- |

Condensing PV Series

WARNING: If the information in these instructions is not followed exactly, a fire or explosion may result causing property damage, personal injury, or death.

FOR YOUR SAFETY

Do not store or use gasoline or other flammable, combustible, or corrosive vapors and liquids in the vicinity of this or any other appliance.

WHAT TO DO IF YOU SMELL GAS!

- Do not try to light any appliance.
- Do not touch any electrical switch; do not use any phone in your building.
- Immediately call your gas supplier from a neighbor's phone. Follow the gas supplier's instructions.
- If you cannot reach your gas supplier, call the fire department.

Installation and service must be performed by a qualified installer, service agency or the gas supplier.

⚠ DANGER

Do not store or use gasoline or other flammable, combustible, or corrosive vapors and liquids in the vicinity of this or any other appliance.

IMPORTANT

Before proceeding, please inspect the water heater and its components for possible damage. DO NOT install any water heater with damaged components. If damage is evident then please contact the supplier where the water heater was purchased or the manufacturer listed on the rating plate for replacement parts.

⚠ WARNING

Water heaters are heat producing appliances. To avoid damage or injury, do not store materials against the water heater or vent-air intake system. Use proper care to avoid unnecessary contact (especially by children) with the water heater and vent-air intake components. **UNDER NO CIRCUMSTANCES MUST FLAMMABLE MATERIALS, SUCH AS GASOLINE OR PAINT THINNER BE USED OR STORED IN THE VICINITY OF THIS WATER HEATER, VENT-AIR INTAKE SYSTEM OR IN ANY LOCATION FROM WHICH FUMES COULD REACH THE WATER HEATER OR VENT-AIR INTAKE SYSTEM**

⚠ CAUTION

If sweat fittings are to be used **DO NOT** apply heat to the nipples on top of the water heater. Sweat the tubing to the adapter before fitting the adapter to the water connections. It is imperative that heat is not applied to the nipples containing a plastic liner.

⚠ WARNING

Hydrogen gas can be produced in an operating water heater that has not had water drawn from the tank for a long period of time (generally two weeks or more). Hydrogen gas is extremely flammable. To prevent the possibility of injury under these conditions, we recommend the hot water faucet to be open for several minutes at the kitchen sink before you use any electrical appliance which is connected to the hot water system. If hydrogen is present, there will be an unusual sound such as air escaping through the pipes as hot water begins to flow. Do not smoke or have open flame near the faucet at the time it is open.

⚠ WARNING

DO NOT ATTEMPT TO LIGHT ANY GAS APPLIANCE IF YOU ARE NOT CERTAIN OF THE FOLLOWING:

- Liquefied petroleum gases/propane gas and natural gas have an odorant added by the gas supplier that aids in the detection of the gas.
- Most people recognize this odor as a "sulfur" or "rotten egg" smell.
- Other conditions, such as "odorant fade" can cause the odorant to diminish in intensity, or "fade", and not be as readily detectable.
- If you have a diminished sense of smell, or are in any way unsure of the presence of gas, immediately contact your gas supplier from a neighbor's telephone.

Gas detectors are available. Contact your gas supplier, or plumbing professional, for more information.

⚠ WARNING

FAILURE TO INSTALL AND MAINTAIN A NEW, LISTED 3/4" X 3/4" TEMPERATURE AND PRESSURE RELIEF VALVE WILL RELEASE THE MANUFACTURER FROM ANY CLAIM THAT MIGHT RESULT FROM EXCESSIVE TEMPERATURE AND PRESSURES.

⚠ CAUTION

Turn off or disconnect the electrical power supply to the water heater before servicing. Label all wires prior to disconnection when servicing controls. Wiring errors can cause improper and dangerous operation. Verify proper operation after servicing.

Condensing PV Series

Introduction

The new Bradford White residential condensing water heaters are designed to provide reliable performance with enhanced standard features. New design features include reliable spark to pilot ignition system, enhanced diagnostics, simplified servicing, significantly quiet operation and additional vent lengths.

Spark to Pilot Ignition System - employing the spark to pilot ignition system promotes reliable and consistent pilot and main burner ignitions to provide hot water on demand.

Integrated Immersion Thermostat/Gas Control Valve with LED - was developed for ease of troubleshooting by providing simple diagnostic codes to pinpoint an installation or component performance issue.

New Powerful Blower - will eliminate problems with difficult venting situations.

Quieter and Cooler Blower Operation - blower noise is significantly reduced for both interior and exterior environments. Cooler operation increases blower life by reducing bearing wear and noise.

Rugged Wiring Connections - receptacle type connections promote error free wiring.

Increased Vent Lengths - increased venting performance is achieved while achieving 90% Thermal Efficiency and enhanced Standby Loss performance.

The residential condensing water heaters use a combustion system where the flue gases are pulled at a low temperature from the water heater directly into the blower. The flue gases are evacuated to the exterior through low temperature vent materials. The gas control maintains water temperature, ignition sequence and regulates gas flow. A safety circuit consisting of a pressure switch and blower temperature switch verifies proper conditions exist for safe and reliable operation. If a situation outside of normal operating parameters exists, the gas control diagnostic LED will flash a code to positively identify an operational issue.

This service manual is designed to facilitate problem diagnosis and enhance service efficiency.

Please read the service manual completely before attempting service on this new series of condensing power vent models.

Condensing PV Series

How to Use This Manual

It is intended for this manual to be used by qualified service personnel for the primary purpose of troubleshooting and repair of the Bradford White Condensing PV Series water heaters. Understanding the sequence of operation section of this manual will contribute greatly to troubleshooting the water heater.

The Honeywell WV4462A Electronic Gas Control will display error codes in the event of abnormal operation. Error codes are listed in the troubleshooting chart of this service manual. The troubleshooting chart will also indicate the probable cause for the error code and direct the service professional to a service procedure to properly diagnose the abnormal operation.

In some difficult to diagnose conditions, it may be necessary to isolate the heater from the vent system to determine the problem.

Contact the Bradford White technical support group immediately if diagnosis cannot be made using the methods described in this service manual.

Tools Required for Service

| | |
|----------------------|--|
| Manometer: | A liquid "U" tube type or a digital (magnahelic) type can be used. This device is used to measure gas and/or air pressure and vacuum. |
| Multi-Meter: | A digital type is strongly recommended. This device is used to measure electrical values. The meter you select must have the capability to measure volts AC, volts DC, Amps, micro-amps and ohms. |
| Electronic Probes: | In some cases, standard multi-meter probes will damage or simply not be effective to obtain certain voltage and ohm readings. It will be necessary to have special electronic "pin" type multi-meter probes. These probes are available at most electronic wholesale outlets. |
| Thermometer: | Used to measure water temperature. An accurate thermometer is recommended. |
| Water Pressure Gage: | Used to measure water supply pressure. Also used to determine tank pressure by adapting to the drain valve of the heater. |
| Various Hand Tools: | Pipe wrench, channel locks, open end wrenches (3/8", 7/16", 1/2"), 12" crescent wrench, allen wrench set, screw drivers (common & Phillip's), 1/4" & 5/16" nut driver, pliers (common & needle nose), socket set, side cutters, wire cutters, wire strippers, wire crimpers, torpedo level, small shop vac, step ladder, flashlight and 5-gallon pail. |

Condensing PV Series

Specifications

| | |
|---|--|
| Power supply | Dedicated 115 VAC, 60 Hz, 15A. |
| Gas Supply Pipe | Minimum 1/2" NPT (schedule 40 black iron pipe recommended). |
| Approved Gas Type | Natural Gas or Propane, unit must match gas type supplied. |
| Gas Pressure | 5.0" w.c. min. for Natural Gas, 11.0" w.c. min. for Propane, 14.0" w.c. maximum (Natural Gas & Propane). |
| Venting System | Power vent through the wall or vertical through the roof. |
| Approved Vent Materials | PVC, CPVC or ABS. |
| Minimum Clearance for Servicing | 18" from top, 24" from front, 4" sides and rear. |
| Water Supply Pressure | 150 psi maximum allowable working pressure. Check local codes for supply pressure. |
| Gas Control ECO Limit | Residential 188°F (87°C), Commercial 199°F (93°C). |
| Residential Temperature Set Point Range | 60°F (16°C) to 160°F (71°C) (approximate temperatures). |
| Commercial Temperature Set Point Range | 80°F (27°C) to 180°F (82°C) (approximate temperatures). |
| Blower Temperature Switch | Normally closed, opens @ 155°F (68°C), auto reset @ approximately 135°F (57°C). |
| Pressure Switch | Normally open Closes on vacuum increase @ -1.73" w.c. |
| Blower | 115 VAC, 60 Hz, 3.3 amps, 3000 RPM @ 1.5" w.c. |

Glossary of Terms

| | |
|-------|---------------------------|
| BTU | British Thermal Units |
| GPM | Gallons per Minute |
| Hz | Hertz |
| kWhr | Kilowatt Hour |
| LED | Light Emitting Diode |
| NPT | National Pipe Thread |
| Ohms | Ohms of resistance |
| psi | Pounds per Square Inch |
| RPM | Revolutions per minute |
| ECO | Energy Cut Out |
| VAC | Volts Alternating Current |
| "w.c. | Inches of Water Column |
| °C | Degrees Centigrade |
| °F | Degrees Fahrenheit |

Vent Tables

| 2" Diameter (5.1 cm) Vent Connector Lengths | | | |
|---|-------------|---------------------------------|---------------------------------|
| Terminating | # of Elbows | Maximum Straight Length ft. (m) | Minimum Straight Length ft. (m) |
| Through the Wall | 1 | 45 (13.7) | 2 (.6) |
| Through the Wall | 2 | 40 (12.2) | 2 (.6) |
| Through the Wall | 3 | 35 (10.7) | 2 (.6) |
| Through the Wall | 4 | 30 (9.2) | 2 (.6) |
| Through the Roof | 0 | 50 (15.2) | 7 (2.1) |
| Through the Roof | 1 | 45 (13.7) | 7 (2.1) |
| Through the Roof | 2 | 40 (12.2) | 7 (2.1) |
| Through the Roof | 3 | 35 (10.7) | 7 (2.1) |
| Through the Roof | 4 | 30 (9.2) | 7 (2.1) |

| 3" Diameter (10.2 cm) Vent Connector Lengths | | | |
|--|-------------|---------------------------------|---------------------------------|
| Terminating | # of Elbows | Maximum Straight Length ft. (m) | Minimum Straight Length ft. (m) |
| Through the Wall | 1 | 115 (35.0) | 10 (3.1) |
| Through the Wall | 2 | 110 (33.5) | 10 (3.1) |
| Through the Wall | 3 | 105 (32.0) | 10 (3.1) |
| Through the Wall | 4 | 100 (30.5) | 10 (3.1) |
| Through the Wall | 5 | 95 (29.0) | 10 (3.1) |
| Through the Roof | 0 | 120 (36.6) | 15 (4.6) |
| Through the Roof | 1 | 115 (35.0) | 15 (4.6) |
| Through the Roof | 2 | 110 (33.5) | 15 (4.6) |
| Through the Roof | 3 | 105 (32.0) | 15 (4.6) |
| Through the Roof | 4 | 100 (30.5) | 15 (4.6) |

Vent Tables

| 4" Diameter (10.2 cm) Vent Connector Lengths | | | |
|--|-------------|---------------------------------|---------------------------------|
| Terminating | # of Elbows | Maximum Straight Length ft. (m) | Minimum Straight Length ft. (m) |
| Through the Wall | 1 | 180 (54.9) | 10 (3.1) |
| Through the Wall | 2 | 175 (53.3) | 10 (3.1) |
| Through the Wall | 3 | 170 (51.8) | 10 (3.1) |
| Through the Wall | 4 | 165 (50.3) | 10 (3.1) |
| Through the Wall | 5 | 160 (48.8) | 10 (3.1) |
| Through the Roof | 0 | 180 (54.9) | 15 (4.6) |
| Through the Roof | 1 | 175 (53.3) | 15 (4.6) |
| Through the Roof | 2 | 170 (51.8) | 15 (4.6) |
| Through the Roof | 3 | 165 (50.3) | 15 (4.6) |
| Through the Roof | 4 | 160 (48.8) | 15 (4.6) |

Control Timings

| <u>Ignition State</u> | <u>Timing</u> |
|------------------------------------|--|
| Pre-purge | 2 Seconds |
| Trial for Ignition | 90 Seconds |
| Flame Stabilization Period | 3 Seconds |
| Inter-purge | 15 Seconds |
| Flame Failure Response Time | 1.5 Seconds (2 second maximum; 1 second minimum.) |
| Post-purge | 15 Seconds |
| PS Fault Delay (failed open/close) | Retry after 2 minutes |
| Soft Lockout | Retry after 5 minutes |
| ECO Limit Lockout | Indefinite (see PV SERVICE PROCEDURE VI; page 26) |
| Verify Resistive Delay | Retry after 2 minutes (repeats 5 times) |
| Simulated Resistive Load Lockout | Indefinite (cycle power to restart) |
| Hardware Error Lockout | Indefinite (self clears if fault clears for at least 15 seconds) |

WIRING DIAGRAM

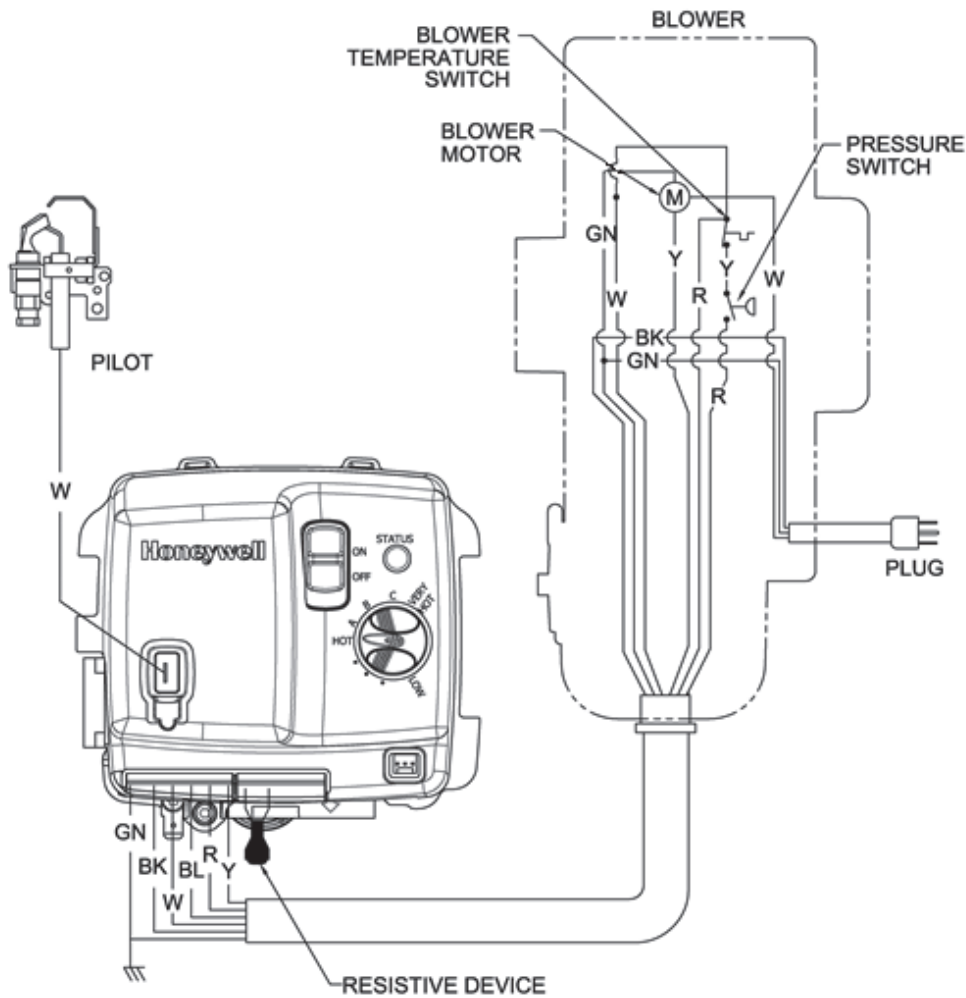

Power Up Sequence

1. Start Up.

Upon power up, the control runs a safe-start check with a typical start-up delay of 5 seconds.

2. Flammable Vapor.

To assure no outputs are energized if the “Simulated Resistive Device” is out of range, the control will test the “Simulated Resistive Device” for proper operating range. If “Simulated Resistive Device” is out of range, the control LED immediately flashes 7 times with a 3 second pause.

Normal Heating Sequence

1. Thermostat calls for heat.

Prior to energizing the blower, the gas control checks the safety circuit to ensure that the circuit is open. Normal switch positions in the safety circuit are as follows:

- a) Pressure switch normally open.
- b) Blower temperature switch normally closed.

If the safety circuit is closed, the control waits 4 seconds, then the gas control LED flashes 2 times with a 3 second pause. The gas control waits 2 minutes and then the blower runs for 30 seconds. This cycle repeats until the safety circuit opens.

2. Blower energizes.

3. Pressure switch proves blower/vent system operation.

If the pressure switch does not close within 30 seconds, the control LED flashes 3 times with 3 second pause. The blower runs for 30 seconds every 2 minutes trying to get the pressure switch or blower temperature switch to close. This cycle repeats as long as there is a call for heat.

4. Blower pre-purge period (2 seconds).

5. Trial for pilot ignition (90 seconds).

- a. The gas control lights the pilot by activating the spark igniter and gas flow to the pilot burner.
- b. If the flame is not sensed within 90 seconds, the igniter and gas flow are deactivated, the blower will post purge and the control LED flashes 6 times with a 3 second pause.

6. Main burner ignition.

After the pilot flame is sensed, the gas control activates the main valve for main burner ignition. The gas control will ignore the flame and pressure switch signals for 3 seconds allowing for the main burner to stabilize.

Normal Heating Sequence (cont.)

7. Steady state operation.

During steady state operation, the control monitors:

Thermostat temperature sensor-when the set point temperature is satisfied, the gas valve is shut down and the blower will post purge for 15 seconds. The control LED flashes a short flash once every 4 seconds (idle) status code.

Pressure switch / blower temperature switch-if either switch opens, the pilot valve and the main valve are both shut down. The blower continues to run for 30 seconds attempting to close the circuit. The control LED flashes 3 times with a 3 second pause.

Flame sensor-if flame is lost, the pilot & main valves are shut down and the blower runs for 15 seconds. The control attempts to re-light the pilot 4 times. If unsuccessful, the blower is shut down and the control proceeds to a 5 minute lockout. The control re-attempts to light pilot starting at normal heating sequence #2.

8. Thermostat satisfies. (Control LED flashing once every 4 seconds).

9. Burner off.

10. Blower post purges (15 seconds).

Abnormal Operation

1. Simulated Resistive Device Fault:

a. **If the resistance is greater than 70,000 Ohms**-the gas control immediately turns off all outputs. The control waits and monitors the resistance for 30 seconds. If the resistance is greater than 65,000 ohms after 30 seconds, the gas control proceeds to verify resistive delay for 2 minutes and flashes 7 times, then once with a three second pause. This process is repeated 5 times until the control either returns to normal operation or proceeds to flammable vapor lockout.

b. **If the resistance is below 3000 Ohms**-The gas control immediately turns off all outputs and proceeds to flash 8 times, then once with a three second pause. The error self clears if the resistance returns to normal range for at least 15 seconds.

2. Temperature Sensor Fault:

a. **Temperature sensor detected open circuit**-The gas control immediately turns off all outputs and proceeds to flash 8 times, then 3 times with a 3 second pause. The error self clears if the fault clears for at least 15 seconds.

b. **Thermal well sensor not reading the same temperature within $\pm 5.5^{\circ}\text{F}$** – The gas control immediately turns off all outputs and proceeds to flash 8

Abnormal Operation (cont.)

- times, then 3 times twice with 3 second pauses. The error self clears if the fault clears for at least 15 seconds.
- c. **Water temperature in excess of ECO (Energy Cut Out) limit** -The gas control immediately turns off the pilot & main valves and proceeds to flash 4 times with a 3 second pause. The blower continues to run until the gas control is reset. To reset the control, rotate the temperature control knob to the minimum setting for at least 6 seconds before returning to the desired temperature setting.
3. Pressure Switch/Blower Temperature Fault:
 - a. **Pressure switch closed at start of call for heat**-the gas control waits 4 seconds, then proceeds to flash 2 times a with 3 second pause. The control waits 2 minutes and then turns on the blower for 30 seconds. The blower turns off after 30 seconds and the control waits for the pressure switch to open. Any time the pressure switch opens, the blower turns on (or stays on) and the control proceeds to wait for the pressure switch to close.
 - b. **Pressure switch or blower temperature switch failed to close**-the gas control runs the blower for 30 seconds waiting for the pressure switch and/or blower temperature switch to close. If either switch does not close in 30 seconds, the blower turns off and the control flashes 3 times with a 3 second pause. The gas control waits 2 minutes before turning on the blower for another 30 seconds to check if the circuit will close. This cycle repeats as long as there is a call for heat or until the circuit closes.
 - c. **Pressure switch or blower temperature switch opens during burner operation**-the gas control turns off the pilot and main valve and runs the blower for 15 seconds (inter-purge), waiting for the pressure switch and/or blower temperature switch to close. If either switch fails to close, the control proceeds as described in 3b above. If the circuit closes again by the end of the inter-purge, the recycle counter is incremented, if the recycle count has not reached its limit (4), another trial for ignition begins. If the recycle count has been reached, the gas control turns off the blower and flashes 6 times, then 2 times with a 3 second pause. The gas control waits 5 minutes before repeating ignition sequence.
 4. Trial for Ignition Fault:
 - a. **Pressure switch opens during trial**-the gas control turns off the igniter and pilot valve. The gas control proceeds as described in 3b above. If the pressure switch closes within 30 seconds, the gas control will continue with trial for ignition starting at blower pre-purge.
 - b. **Flame not sensed**-the gas control energizes the spark igniter attempting to light the pilot and prove flame. If the flame is not sensed within 90 seconds, the igniter turns off, the pilot valve is closed and the gas control runs the

Abnormal Operation (cont.)

blower through post purge and flashes 6 times, then, a one time 3 second pause. The control waits 5 minutes before repeating the ignition sequence.

5. Flame sensing fault:

- a. **Flame lost during run**-the gas control turns off the pilot and main valves and runs blower for 15 seconds (inter-purge). The gas control increments the recycle count. If the recycle count has not reached its limit (4), another trial for ignition begins. If the recycle count limit has been reached, the gas control turns off the blower and flashes 6 times, then 3 times with a 3 second pause. The gas control waits 5 minutes before repeating the ignition sequence.
- b. **Flame sensed out of sequence**-the gas control only looks for pilot flame when the blower is running. If the flame is present when the pilot valve is not open, the gas control proceeds to wait for flame loss and flashes 5 times with a 3 second pause. This continues until flame signal is lost. Once the flame signal is lost, the control flashes 6 times, then 4 times with a 3 second pause. The control waits 5 minutes before repeating the ignition sequence.

Condensing PV Series

Troubleshooting

Observe green LED indicator on electronic gas control. Error flash codes are displayed with a three second pause before repeating. Check and repair the system as noted in the troubleshooting table below.

| <u>LED Status</u> | <u>Control Status</u> | <u>Probable Cause</u> | <u>Service Procedure</u> |
|--------------------------------------|--|---|---|
| None, control LED not on or flashing | No electrical Power. | Control power switch in "OFF" position. Supply voltage interrupted. | Turn power on |
| Short flash once every four seconds | Stand-by mode, waiting for call for heat (no fault). | Temperature demand is satisfied. | Normal operation. Adjust thermostat to temperature level. |
| "Heartbeat" alternates bright/dim | Thermostat calling for heat (no fault). | Tank temperature below set point of thermostat. | Normal operation. Adjust thermostat to temperature level. |
| Short flash once per second | Weak pilot signal on last call for heat. | <ol style="list-style-type: none"> 1. Unstable pilot. 2. Pilot tube blocked or restricted. 3. Oxidation build up on pilot electrode. 4. Wire damage to pilot assembly or bad connection at gas valve. 5. Low gas pressure. | Page 18 Procedure II |
| Two flash, three second pause | Pressure switch not working-closed position. | <ol style="list-style-type: none"> 1. Pressure switch tubing kinked or blocked. 2. Blocked pressure tap on switch or blower. 3. Faulty pressure switch. | Page 19 Procedure III |
| Three flash, three second pause | Pressure switch or blower temp. switch not working -open position. | <ol style="list-style-type: none"> 1. Vent blockage or improper vent configuration. 2. Pressure switch tubing kinked or blocked. 3. Faulty pressure switch. 4. Blower not spinning up to speed. 5. Blower temp or exhaust temp too high. 6. Faulty blower temperature switch. | <ol style="list-style-type: none"> 1. Check vent or vent tables. 2. & 3. Page 19 4. Page 21 5. & 6. Page 23 |
| Four flash, three second pause | Excessive tank temperature. System must be reset. | <ol style="list-style-type: none"> 1. Temperature sensor out of calibration. 2. Faulty gas control. 3. Plumbing leak. | <ol style="list-style-type: none"> 1. Page 23 2. Replace gas control, page 27 |
| Five flash, three second pause | Undesired-false pilot flame present. | <ol style="list-style-type: none"> 1. Pilot valve stuck in open position. | Replace gas control, page 27 |

Condensing PV Series

Troubleshooting

| <u>LED Status</u> | <u>Control Status</u> | <u>Probable Cause</u> | <u>Service Procedure</u> |
|---------------------------------------|--|---|--|
| Six-one flash, three second pause | Failed to light pilot. System auto resets. | <ol style="list-style-type: none"> 1. Unstable pilot. 2. Pilot tube blocked or restricted. 3. Oxidation build up on pilot electrode. 4. Wire damage to pilot assembly or bad connection at gas valve. 5. Low gas pressure. | Page 18 |
| Six-two flash, three second pause | Pressure switch or blower temp switch opened during burner operation. System auto resets. | <ol style="list-style-type: none"> 1. Vent blockage or improper vent configuration. 2. Pressure switch tubing kinked or blocked. 3. Faulty pressure switch. 4. Vent termination being affected by wind. 5. Blower not spinning up to speed. 6. Blower temp or exhaust temp too high. 7. Faulty blower temperature switch. 8. Blocked condensate trap. | <ol style="list-style-type: none"> 1. Check vent or vent tables. 2. & 3. Page 19 4. Refer to venting section of installation manual. 5. Page 21 6. & 7. Page 23 8. Page 39 |
| Six-three flash, three second pause | Pilot flame extinguished. System auto resets. | <ol style="list-style-type: none"> 1. Unstable pilot. 2. Pilot tube blocked or restricted. 3. Oxidation build up on pilot electrode. 4. Wire damage to pilot assembly or bad connection at gas valve. 5. Insufficient combustion air. 6. Gas pressure is out of specification. | <ol style="list-style-type: none"> 1.-4. Page 18 5. Refer to installation manual 6. Page 25 |
| Six-four flash, three second pause | Undesired-false pilot flame sensed. System auto resets. | Pilot valve stuck in open position. | Replace gas control, page 27 |
| Seven flash, three second pause | Simulated Resistive Device fault detected. | Simulated resistance device harness out of specification or disconnected. | Page 29 |
| Eight-one flash, three second pause | Simulated Resistive Device out of specification. | Simulated resistive device out of specification. Possible short. | Page 29 |
| Eight-two flash, three second pause | Temperature sensor fault. | <ol style="list-style-type: none"> 1. Damage to temperature sensor wire. 2. Temperature sensor resistance out of range. | Page 27 |
| Eight-three flash, three second pause | Gas valve electronics fault detected. | <ol style="list-style-type: none"> 1. Control needs to be reset. 2. Control is wet or physically damaged. | <ol style="list-style-type: none"> 1. Interrupt power supply. 2. Replace gas control, page 27 |
| Eight-four flash, three second pause | Gas valve fault detected. | <ol style="list-style-type: none"> 1. Control needs to be reset. 2. Control is wet or physically damaged. | <ol style="list-style-type: none"> 1. Interrupt power supply. 2. Replace gas control, page 27 |

Burner Inspection

At periodic intervals (every 6 months) a visual inspection should be made of the pilot and main burner for proper operation and to ensure no debris is accumulating.

The pilot flame should be stable. Some causes for an unstable pilot flame are:

- a) The water heater vent is less than the allowable vent length.
- b) The gas pressure is out of specification.
- c) The pilot flame is not fully engulfing the spark/flame sensor.

The main burner should light smoothly from the pilot and burn with a blue flame and a minimum of yellow tips.

The main burner must be free from any debris accumulation that may affect burner operation (see burner cleaning procedure on page 17).

Burner Cleaning

- Step 1. Position the gas control power switch to the "OFF" position and unplug the water heater from wall outlet.
- Step 2. Turn off the gas supply to the water heater.
- Step 3. Remove the outer jacket door and inner door per Service Procedure XIII on page 36.
- Step 4. Disconnect the pilot tube (7/16" wrench) and feedline (3/4" wrench) from the gas control.
- Step 5. Disconnect the igniter/flame sensor wire from the gas control.
- Step 6. Remove the burner assembly from the combustion chamber.
- Step 7. Thoroughly inspect the burner surface area and burner port area and remove any loose debris.
- Step 8. Unscrew the burner from the main burner orifice.

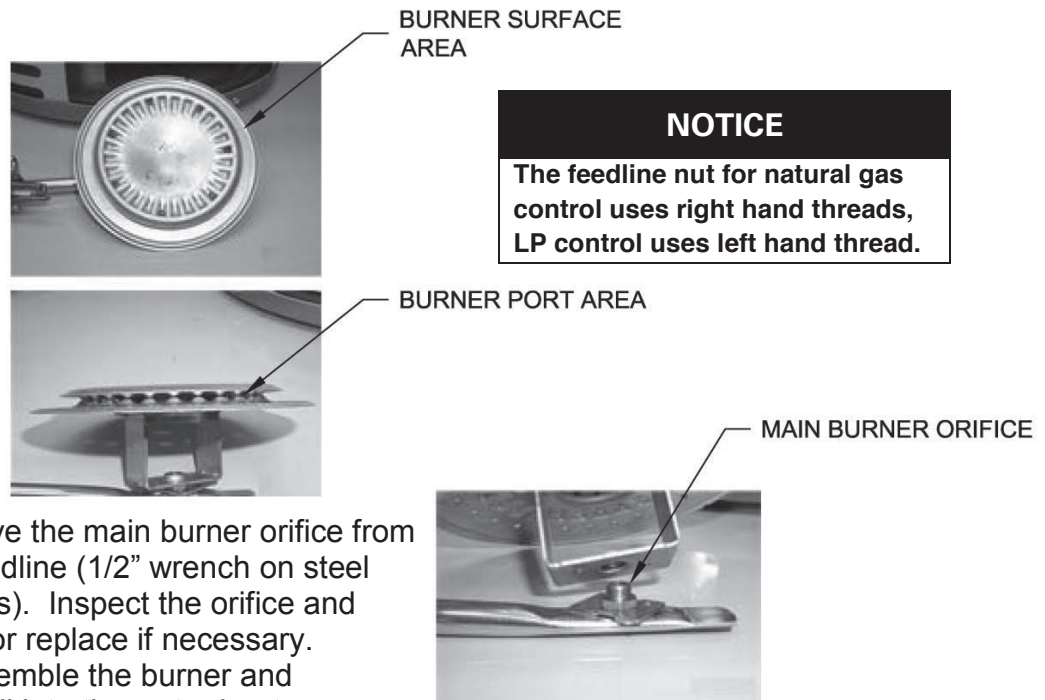

- Step 9. Remove the main burner orifice from the feedline (1/2" wrench on steel burners). Inspect the orifice and clean or replace if necessary.
- Step 10. Reassemble the burner and reinstall into the water heater. Restore the gas supply and check for gas leaks.
- Step 11. To resume operation, follow the instructions located on the lighting instruction label or the lighting instructions located in the Installation and Operation manual.

Pilot Inspection, Cleaning & Replacement

- Step 1. Position the gas control power switch to the "OFF" position and unplug the water heater from wall outlet.
- Step 2. Turn off the gas supply to the water heater.
- Step 3. Remove the outer jacket door and inner door per Service Procedure XIII on page 36.
- Step 4. Disconnect the pilot tubing nut (7/16" wrench) and feedline nut (3/4" wrench) from the gas control.
- Step 5. Disconnect the igniter/flame sense wire from the gas control.
- Step 6. Remove the burner assembly from the combustion chamber.
- Step 7. Remove the pilot assembly from the feedline (1/4" nut driver).
- Step 8. Visually inspect the igniter/flame sense wire for damage. Replace the pilot if damage is found.
- Step 9. With a multi-meter set to the ohms setting, check the continuity through the igniter/flame sense wire. Replace the pilot if there is no continuity.
- Step 10. Visually inspect the igniter/flame sense electrode for deterioration. Replace the pilot as necessary. The electrode should not be in contact with the pilot hood. If so, carefully adjust the electrode to a gap distance of 3/32" (.094") from the pilot hood.
- Step 11. Visually inspect the igniter/flame sense electrode for oxidation build up. Carefully clean any oxidation using a very fine emery cloth.
- Step 12. Visually inspect the pilot tubing for kinks or cracks. If damage is found, replace the pilot.
- Step 13. Inspect the pilot tubing and pilot orifice for blockage:
 - a. Remove the ferrule nut from the bottom of the pilot assembly (7/16" wrench).
 - b. Remove the pilot tube and pilot orifice.
 - c. Inspect the pilot tubing and pilot orifice for blockage. Clean or replace as necessary.
- Step 14. Reassemble pilot and install on feedline. Reinstall burner assembly to water heater. Restore gas supply and check for gas leaks.
- Step 15. To resume operation, follow the instructions located on the lighting instruction label or the lighting instructions located in the installation and operation manual.

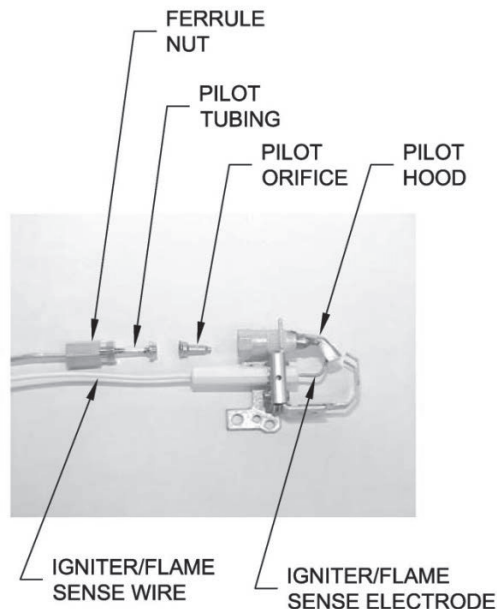

Condensing PV Series

PV SERVICE PROCEDURE III
Pressure Switch Testing & Replacement

Pressure Switch Testing & Replacement

⚠ WARNING

115 volt potential exposure. Use caution to avoid personal injury.

- Step 1. Position the power switch on the gas control to the "OFF" position.
- Step 2. Remove the three screws (Phillips screw driver) from the control access cover on the blower assembly and remove the cover. Do not disconnect the blower harness from the cover (see photo 1).
- Step 3. Remove the 2 screws (Phillips screw driver) and carefully remove the pressure switch to gain access to the wire lead connections (see photo 2).



Remove 3 Phillips screws to remove cover.



Remove 2 Phillips screws to pressure switch.

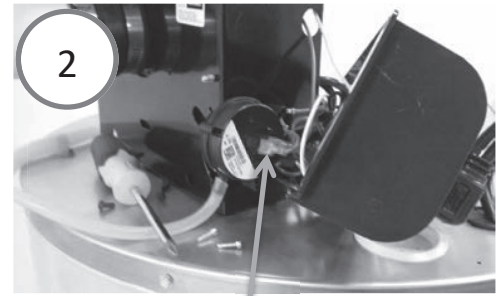

Pressure switch wire leads.

With steps 1,2 & 3 complete, disconnect wire leads from pressure switch.

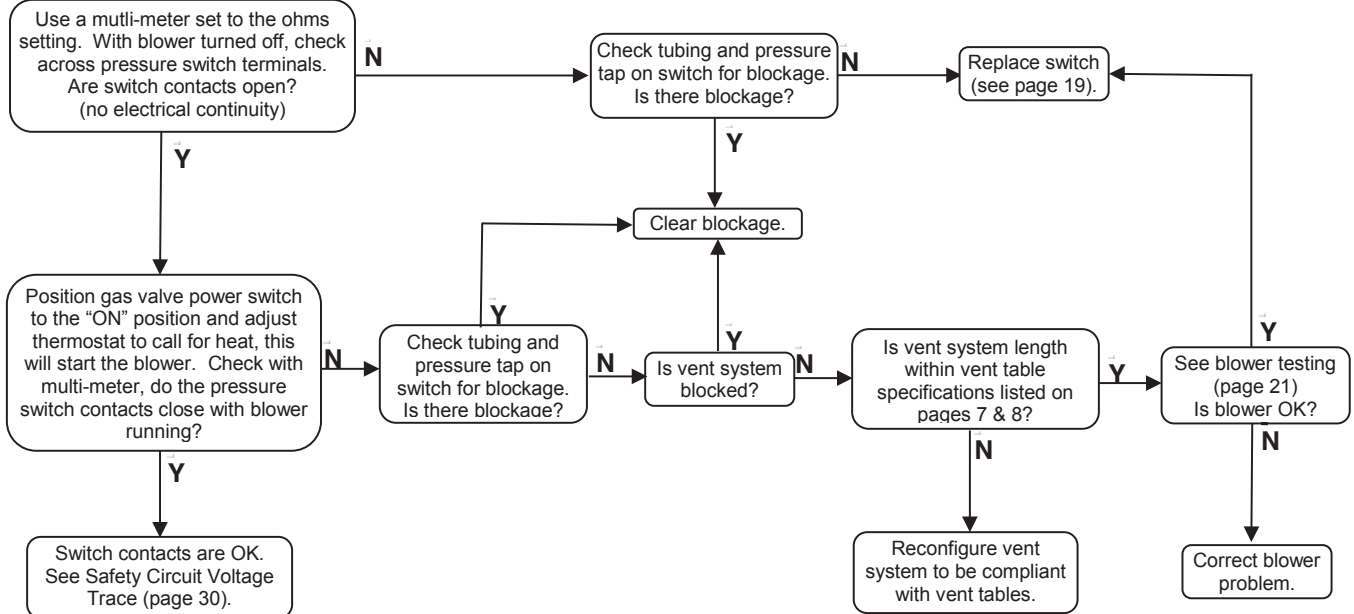

Pressure Switch Replacement

⚠ WARNING

115 volt potential exposure. Use caution to avoid personal injury.

- Step 1. Position the gas control power switch to the "OFF" position.
- Step 2. Disconnect the tubing from the pressure switch (see photo 3).
- Step 3. Remove three screws (Phillip's screw driver) from the control access cover on the blower assembly and remove the cover (see photo 4).
- Step 4. Remove two screws (Phillips screw driver) from the blower housing and carefully remove the pressure switch (see photo 5).
- Step 5. Disconnect the wire leads from the pressure switch (see photo 6).
- Step 6. Reconnect the wires from Step 5 to the new pressure switch.
- Step 7. Carefully position the pressure switch into the blower housing and replace the screws from Step 4.
- Step 8. Replace the control access cover from Step 3 and fasten in place with the three screws.
- Step 9. Reconnect the tubing to the new pressure switch.
- Step 10. Position the gas control power switch to the "ON" position and verify proper heater operation.

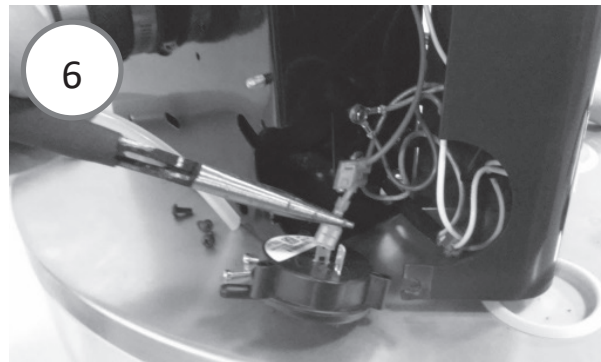
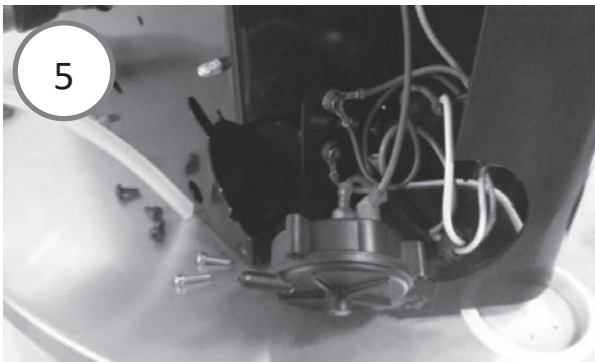
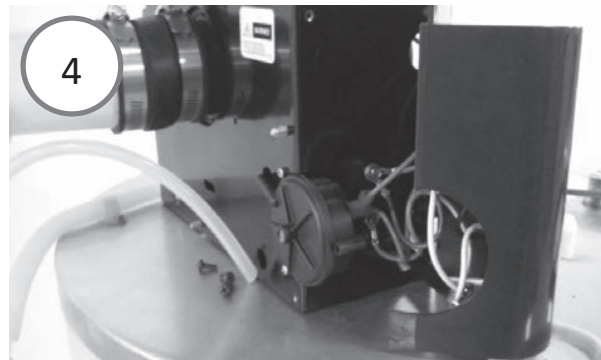

Blower Testing & Replacement

⚠ WARNING
115 volt potential exposure. Use caution to avoid personal injury.

- Step 1. Position gas control power switch to the "ON" position and adjust control to call for heat.
- Step 2. Remove the three screws (Phillip's screw driver) from control access cover on blower assembly and remove cover (see photo 7).

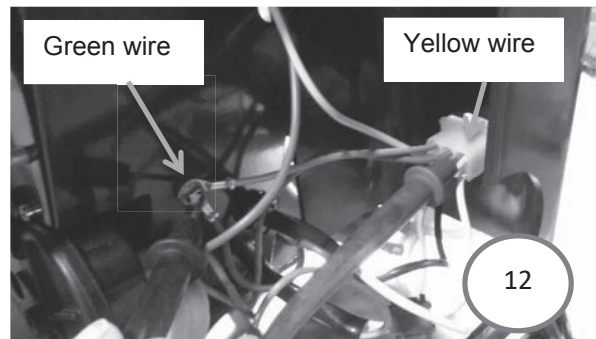
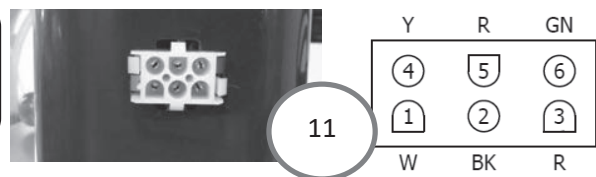
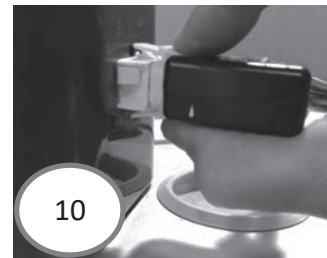
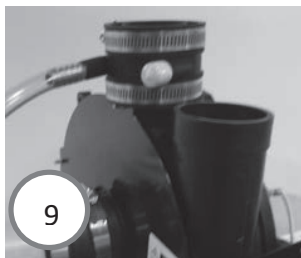
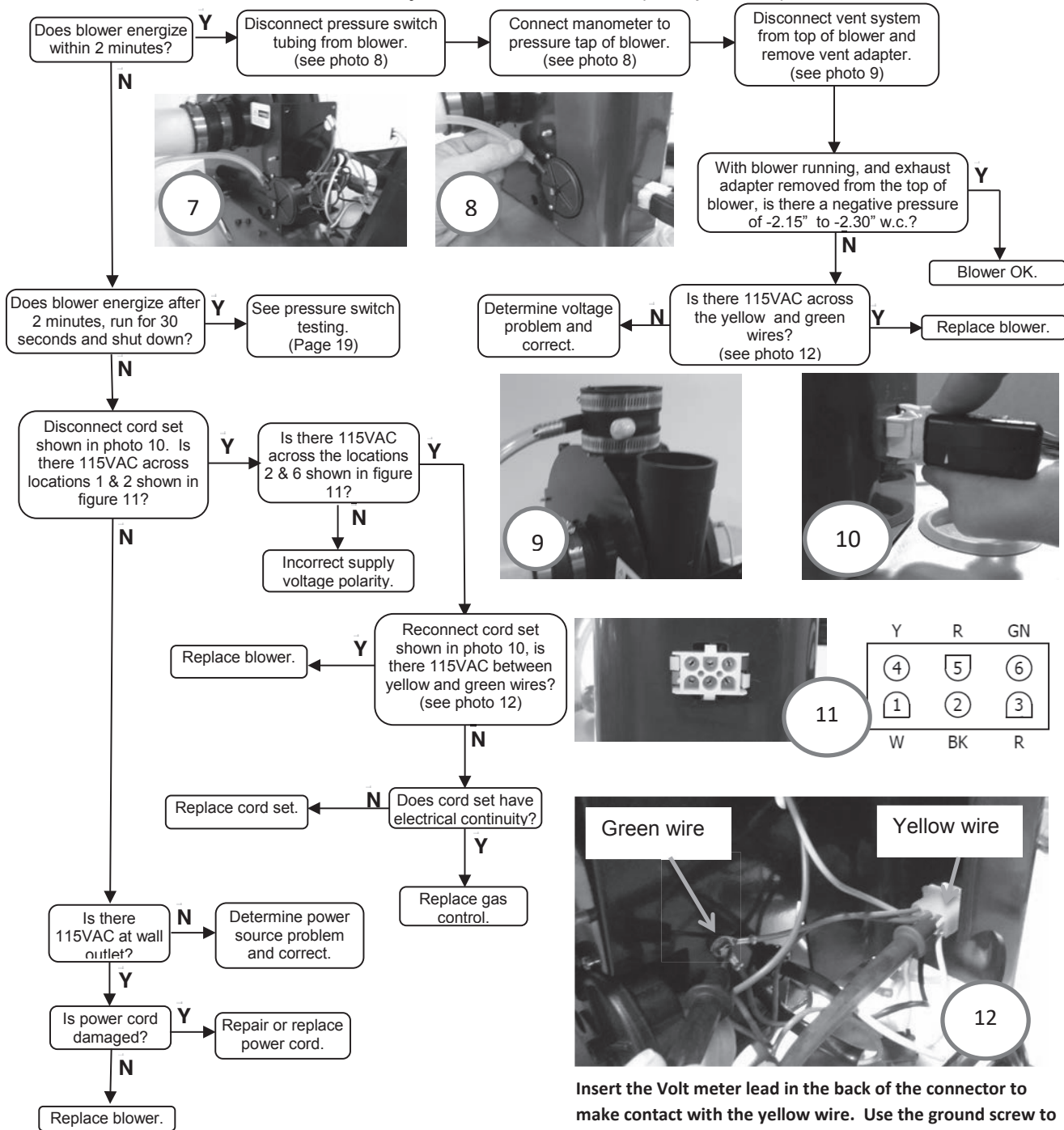

Insert the Volt meter lead in the back of the connector to make contact with the yellow wire. Use the ground screw to make contact with the green wire.

Blower Removal

- Step 1. Position the gas control power switch to the “OFF” position and adjust the control to call for heat.
- Step 2. Unplug the blower power cord from the wall outlet.
- Step 3. Disconnect the vent system from the exhaust adapter on top of the blower.
- Step 4. Remove the brass coupling from the exhaust adapter on the blower and retain for use on the new blower.
- Step 5. Unplug the harness from the blower.
- Step 6. Remove the drain hose from the blower housing.
- Step 7. Remove the hose from the pressure switch.
- Step 8. Remove the vent pipe from the blower intake (slotted screwdriver).
- Step 9. Remove the two blower mounting screws (1/4” nut driver).
- Step 10. Remove the blower from the water heater.

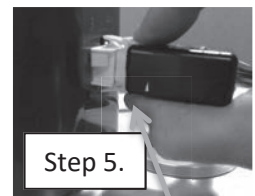
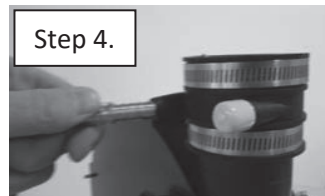

Unclip to remove wire harness.



Loosen hose clamp

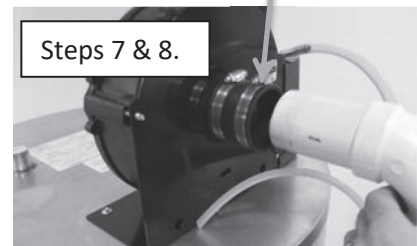

Blower Installation

- Step 11. Clean any debris from the jacket head of water heater.
- Step 12. Set new blower with gasket in place using locating pins on blower flange to line up with location holes in jacket head.
- Step 13. Secure blower in place using mounting screws from step 9.
- Step 14. Re-install vent pipe from step 8 into the blower intake and tighten hose clamp.
- Step 15. Reconnect the hose into the pressure switch from step 7.
- Step 16. Reconnect the drain hose from step 6 into the blower housing.
- Step 17. Plug the harness into the mating connection from step 5. Make sure the connector latches.
- Step 18. Reconnect the brass coupling into the exhaust adapter from step 4.
- Step 19. Reconnect vent system to exhaust adapter.
- Step 20. Plug blower power cord into wall outlet.
- Step 21. Position gas control power switch to the “ON” position.
- Step 22. Verify proper blower operation.

Condensing PV Series

PV SERVICE PROCEDURE V
Blower Temperature Switch Testing & Replacement

Blower Temperature Switch Testing

Step 1. Position power switch on gas control to the "OFF" position.

Step 2. Locate blower temperature switch (see photo 13).

▲ WARNING

115 volt potential exposure. Use caution to avoid personal injury.

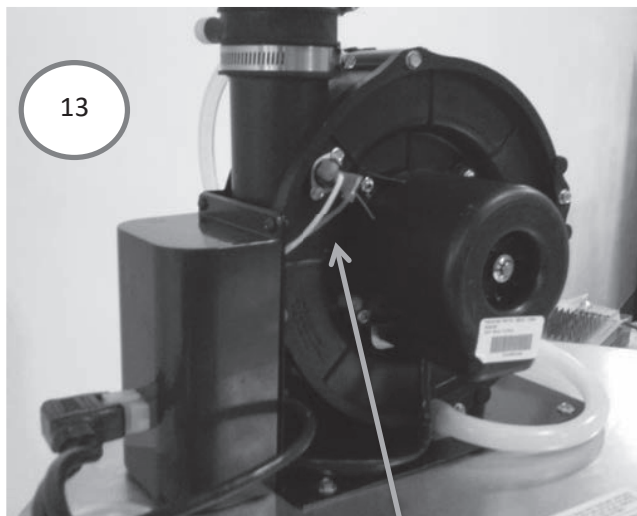

Blower temperature switch

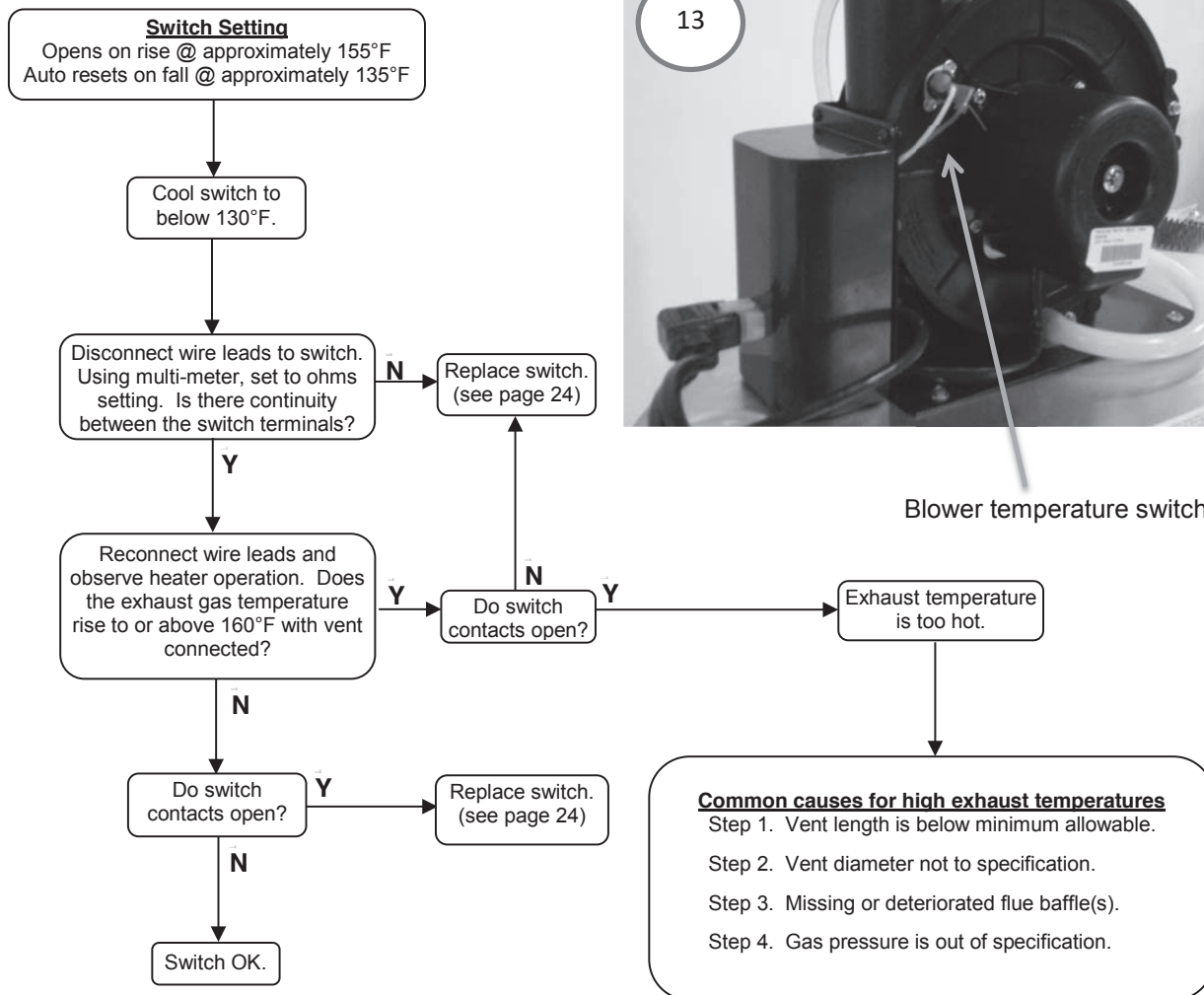

Condensing PV Series

PV SERVICE PROCEDURE V
Blower Temperature Switch Testing & Replacement

Blower Temperature Switch Replacement

⚠ WARNING

115 volt potential exposure. Use caution to avoid personal injury.

- Step 1. Position the gas control power switch to the “OFF” position and unplug the water heater from the wall outlet.
- Step 2. Locate blower temperature switch (see photo 14).
- Step 3. Disconnect red and yellow wire leads from switch.
- Step 4. Remove the two screws (1/4” nutdriver) that locate and hold the temperature switch to the blower housing (see photo 14).
- Step 5. Remove the temperature switch from the blower housing.
- Step 6. Install the new temperature switch. Be sure the temperature switch is properly seated in the mounting area.
- Step 7. Reconnect the red and yellow wires to the new temperature switch. The wires are interchangeable with either terminal.
- Step 8. Plug the water heater into the wall outlet.
- Step 9. Position the gas control power switch to the “ON” position and verify proper heater operation.

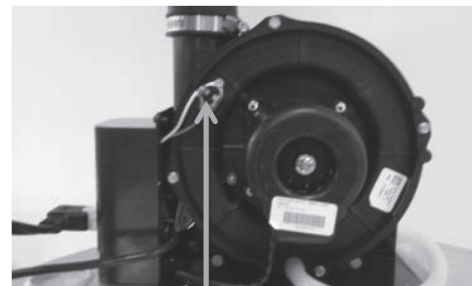

Blower Temperature Switch

Two screws (1/4” slotted head)

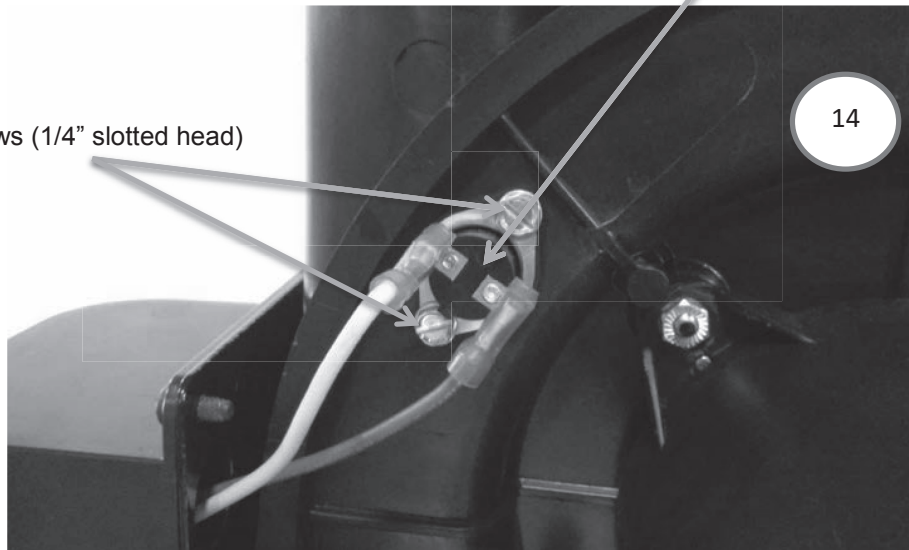

14

Line Pressure

The gas control is designed for a maximum line pressure of 14.0" w.c. and a minimum line pressure of 1.0" w.c. over the water heater's rated manifold pressure (check rating plate). The line pressure must be checked with the main burner both on AND off to assure proper readings.

Manifold Pressure Testing

(this procedure presumes a maximum line pressure of 14.0" w.c.)

- Step 1. Set the Gas Control to the "OFF" position.
- Step 2. Remove the pressure tap plug and install 1/8" NPT pipe, coupling & pressure tap.
- Step 3. Connect a manometer to the pressure tap.
- Step 4. Follow instructions located on the lighting instructions label and proceed to light the main burner and observe manometer reading.
- Step 5. Proper operating range for Natural Gas is 4.0" \pm 0.5" w.c. Proper operating range for Propane gas is 10.0" \pm 0.5" w.c.
- Step 6. If the pressure is within the range specified in the previous step, set the gas control knob to the "OFF" position. Remove the manometer and pressure tap, and replace the pressure tap plug. Check for gas leaks prior to placing the water heater back into operation by following the instructions located on the lighting label, or the lighting instructions located in the installation and operation manual.
- Step 7. If the gas pressure is outside the specification noted above, refer to the Gas Control Testing & Replacement section on page 27 to replace the gas control or valve body.

GAS CONTROL
SHOWN IN THE
"OFF" POSITION



3/16"
ALLEN
WRENCH



PRESSURE TAP
SHOWN INSTALLED

ECO (Energy Cut Out)

The Honeywell gas control is designed with an ECO device that will reset.

If the control has gone into lockout due to excessive tank temperature (four flash, three second pause), reset the control by turning the gas control to the "LOW" position and wait a minimum of (6) seconds. Then rotate the gas control knob to the desired setpoint (at least a 45° rotation) and follow the lighting instructions to return to normal operation.

Observe the Green LED indication.
Does the error code 4 (four flash with a three second pause) continue?

N

Resume normal operation.

Y

Confirm that the water temperature inside the tank has cooled.
Draw approximately 4 gallons of water from the drain valve into a container and discard. Draw an additional gallon and immediately measure the temperature using an accurate thermometer.

If it is confirmed that the water temperature has cooled down below the setpoint level and you are still observing an error code 4 as above, replace the gas control.

Gas Control Removal From The Water Heater

- Step 1. Position the gas control power switch to the “OFF” position and unplug the water heater from the wall outlet.
- Step 2. Drain the water heater to a point below the gas control level.
- Step 3. Turn off the gas supply to the water heater and disconnect gas piping from the gas control.
- Step 4. Disconnect the wire harnesses from the gas control.
- Step 5. Remove the outer jacket burner access door.
- Step 6. Right side inner door removal.
 - a. Remove (2) hex drive screws from RIGHT side inner door.
 - b. Remove (2) hex drive screws from FLANGE SECTION of inner door.
 - c. Remove right side inner door and set aside. Be careful not to damage gasket material in inner door.
- Step 7. Removal of gas control
 - a. Disconnect main burner feedline and pilot tube.
 - b. Remove the gas control from water heater by rotating counter clockwise. DO NOT use a wrench on the gas control body as damage to the gas control may occur. If necessary, use a length of ½” NPT pipe threaded into the gas inlet of the gas control.

¼” HEX DRIVE
SCREWS AT FLANGE
AREA OF INNER DOOR
(STEP 6b).

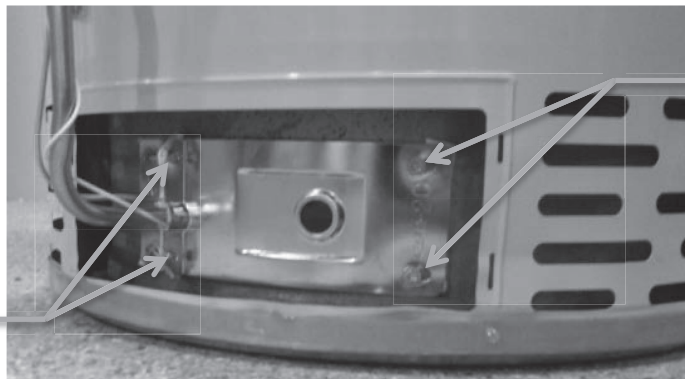

¼” HEX DRIVE SCREWS
ON RIGHT SIDE INNER
DOOR (STEP 6a).

- Step 8. Install the new gas control into the water heater.
 - a. Install new gas control into water heater by rotating clockwise. DO NOT use a wrench on the gas control body as damage to the gas control may occur. If necessary, use a length of ½” NPT pipe threaded into the gas inlet of the gas control.
 - b. Reattach the main burner feedline , pilot tube and pilot wire. The main burner feedline end should rest in the support bracket opening inside the combustion chamber.

Reinstallation of Inner Door Assembly

- c. Prior to reinstallation of inner door, fully inspect for the following:
- Tears
 - Missing material
 - Cracks
 - Dirt or debris
 - Other imperfections that will inhibit proper seal
 - Gasket adhesion to inner door
 - Material left on combustion chamber (around opening)

If the gasket is not affected by any of the above, the gasket replacement may not be required. If a replacement is required, replace using the new gasket kit, following the instructions provided with it.

- d. Clean any gasket residue or other debris from the combustion chamber surface before installing the inner door/gasket assembly.
- e. Position the spark igniter wire and pilot tube against the left side inner door flange gasket. **DO NOT ROUTE THE IGNITER WIRE AND PILOT TUBE THROUGH THE RADIUS CHANNEL WITH THE FEEDLINE.** Be sure that the spark igniter wire and pilot tube are not in a position to interfere with the outer jacket burner access door when reinstalled.
- f. Firmly place right side inner door flange against the left side inner door flange and secure with (2) hex drive screws from step 6b. **DO NOT OVER TIGHTEN SCREWS.**
- g. Align right side inner door to the combustion chamber and verify the fastener holes of the combustion chamber are aligned with the right side inner door slotted openings. Verify seal integrity around combustion chamber opening. Secure right side inner door using (2) hex drive screws from step 6a. **DO NOT OVER TIGHTEN SCREWS.** Verify both left and right sides of the inner door are properly positioned and sealed against the combustion chamber.

⚠ CAUTION

A seal breach may result in a fire or explosion causing property damage, personal injury or death.

- Step 9. Reinstall the outer jacket burner access door.
- Step 10. Reconnect the gas supply to the gas control.
- Step 11. Resume water supply to the water heater. Be sure the tank is full of water before resuming operation.
- Step 12. To resume operation, follow the instructions located on the lighting instruction label or the lighting instructions located in the installation and operation manual.

Simulated Resistive Device Testing

- Step 1. Position the power switch on the gas control to the "OFF" position.
- Step 2. Disconnect flammable vapor sensor or simulated resistive device from the gas control (model dependant).
- Step 3. Using a multi-meter set to the ohms setting, check resistance of the flammable vapor sensor or simulated resistive device. Resistance must be between 3,000 ohms and 48,000 ohms. If outside of this range, replace the simulated resistive device.

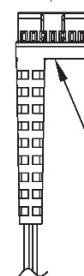
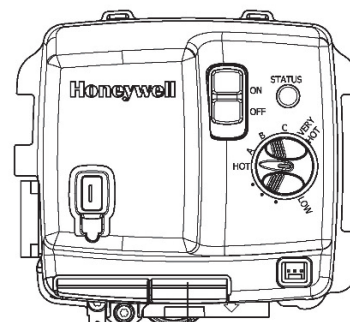

SIMULATED
RESISTIVE
DEVICE HARNESS

CAUTION

DO NOT use a standard multi-meter probe for this test. Doing so will damage connector. Use special pin type electronic probes or small diameter wire pins inserted into connector.

MULTI-METER
SET TO OHMS
SETTING



ELECTRONIC "PIN
TYPE" METER
PROBES

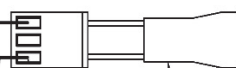

SIMULATED
RESISTIVE
DEVICE

Safety Circuit Voltage Trace

NOTE: This procedure assumes a cool tank. Remove three screws (Phillips Screw driver) from the control access cover on the blower and remove the cover (see photo 17).

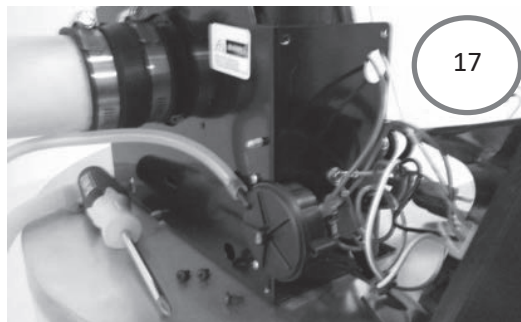

⚠ WARNING
115 volt potential exposure. Use caution to avoid personal injury.

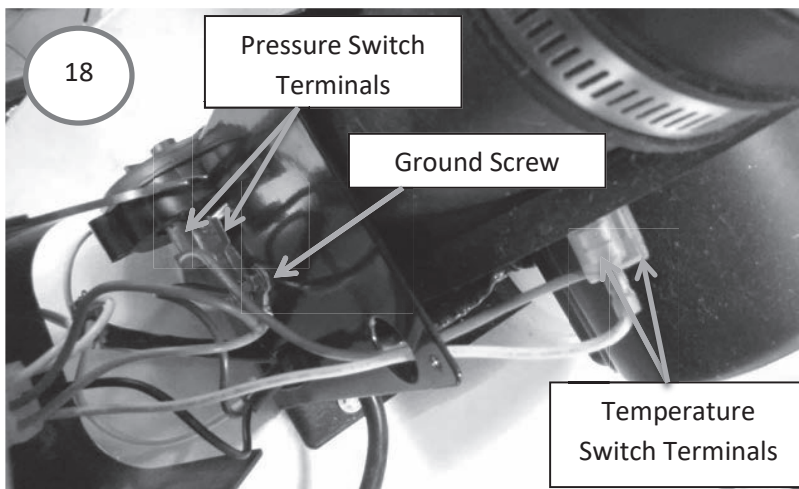
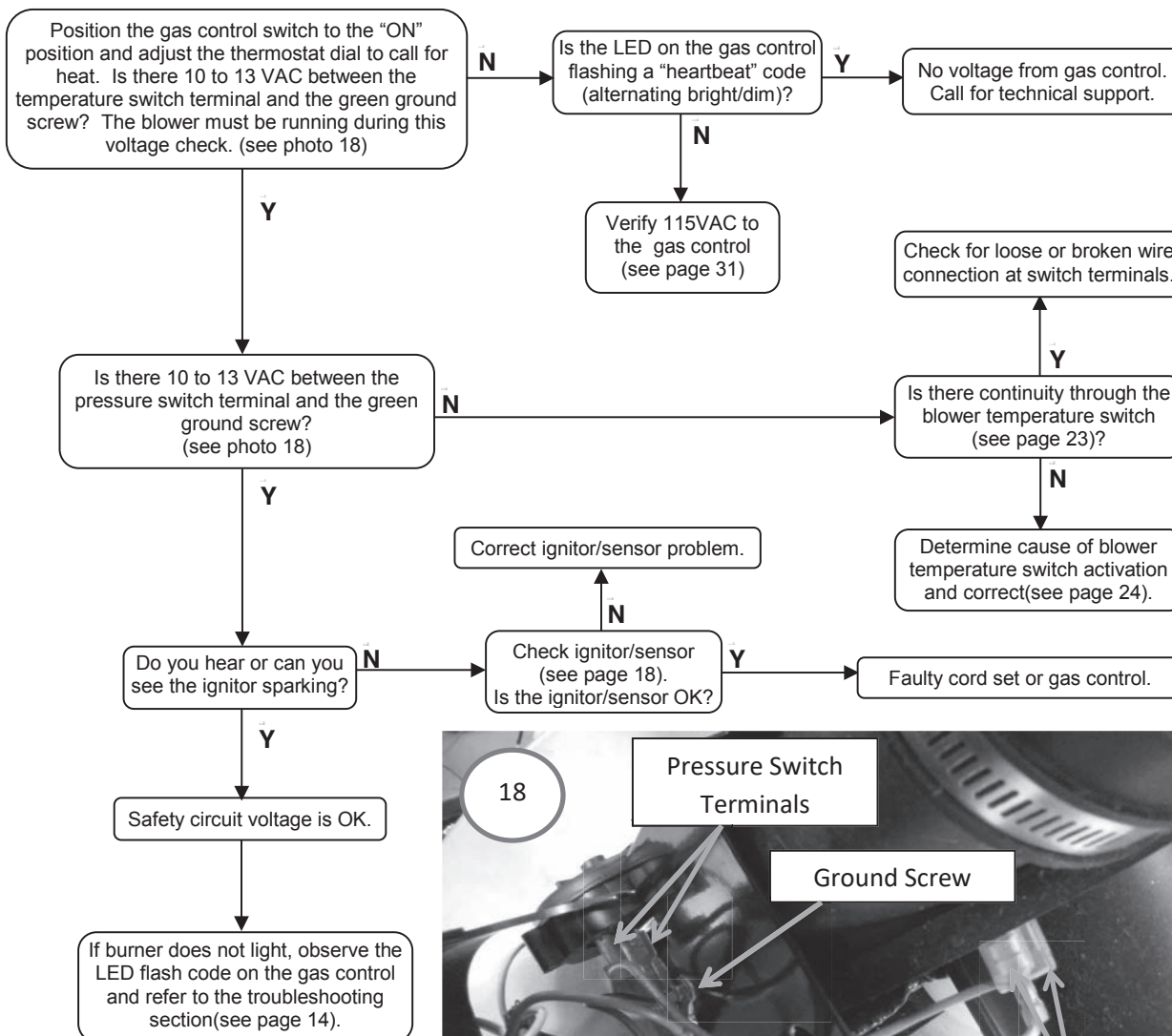

Condensing PV Series

PV SERVICE PROCEDURE IX
115 VAC Trace

115 VAC Circuit Trace

Step 1. Verify 115 VAC and proper polarity at wall outlet.

Step 2. With unit plugged in and control power switch in the "ON" position verify LED status.

⚠ WARNING
115 volt potential exposure. Use caution to avoid personal injury.

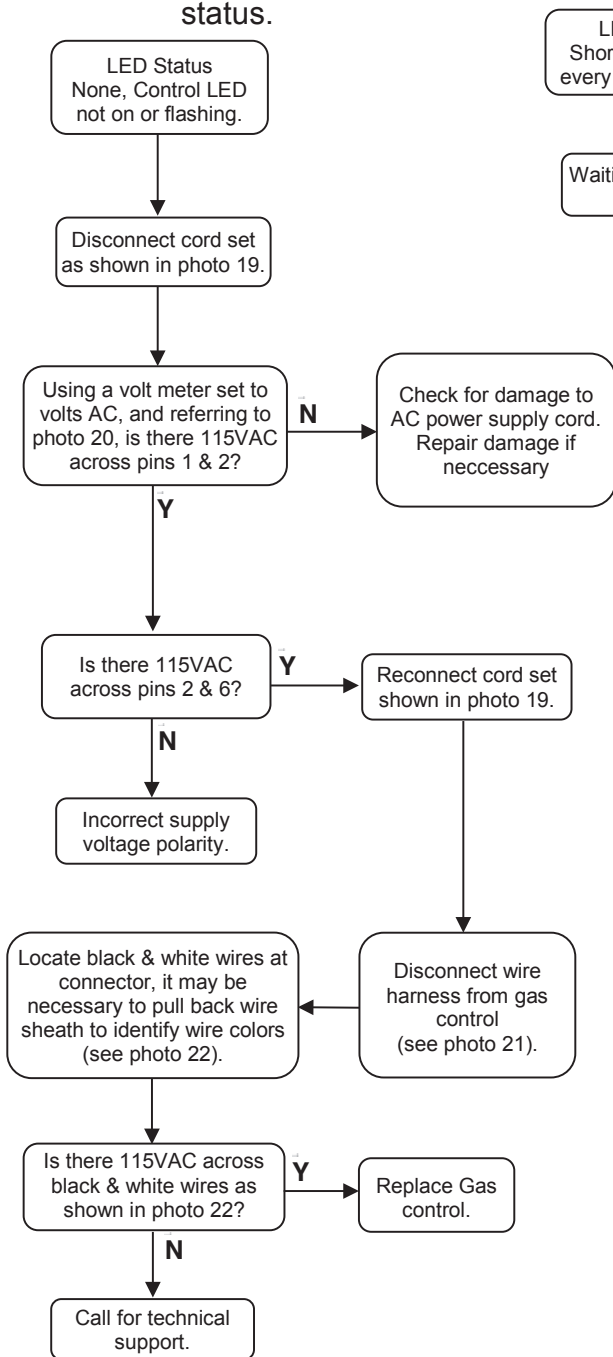

LED Status
Short Flash, once every four seconds.

Waiting for call to heat.

LED Status
"Heartbeat", alternates bright/dim.

Thermostat calling for heat.

LED Status
Other error codes flashing.

Verify error code as listed on page 14.

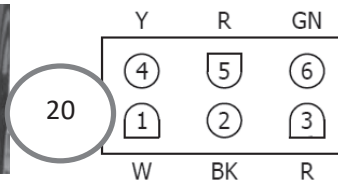
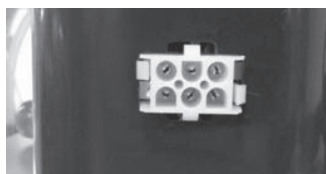
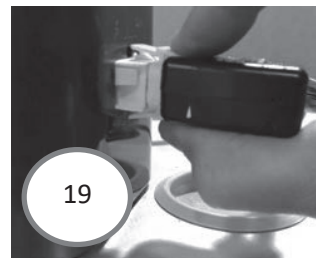

Wire Harness



22

Check for 115VAC between black & white wires.
-NOTE-
Electronic meter probes required. Use care not to damage connector during this check.



Diptube Inspection & Replacement

⚠ WARNING

Water heater components and stored water may be **HOT** when performing the following steps in this procedure. Take necessary precaution to prevent personal injury.

- Step 1. Position the on/off switch of the gas control valve to the “OFF” position and unplug the water heater from the wall outlet.
- Step 2. Turn off the cold water supply to the water heater. Connect a hose to the drain valve of the water heater and route to an open drain. Open a nearby hot water faucet to vent the water heater for draining. Open the drain valve of the water heater and allow the water heater to drain to a point below the inlet connection nipple.
- Step 3. Disconnect the inlet nipple from the plumbing system.
- Step 4. With an appropriate tool such as a pipe wrench, remove the inlet nipple/diptube from the water heater. Use caution not to damage the pipe threads.
- Step 5. Visually inspect the inlet nipple/diptube. The inlet nipple/diptube should be free of cracks and any blockage. The HydroJet slots should be open and free of any blockage. Any damage such as cracks, restriction due to deformation or unintentional holes are not field repairable and the inlet nipple/diptube must be replaced.
- Step 6. Upon completion of inspection or subsequent replacement, reinstall the inlet nipple/diptube into the water heater. Apply Teflon tape or pipe dope to the threads and connect the nipple to the plumbing system, resume the water supply and refill with water.
- Step 7. To resume water heater operation, plug the water heater back into the wall outlet and follow the instructions located on the lighting instruction label or the lighting instructions located in the Installation and Operation manual.

Anode Inspection & Replacement

This water heater has 2 anodes installed. Both anodes require inspection.

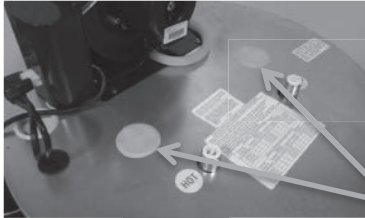

Anodes are located under caps.

⚠ WARNING

Water Heater components and stored water may be **HOT** when performing the following steps in this procedure. Take necessary precaution to prevent personal injury.

- Step 1. Position the on/off switch of the gas control valve to the “OFF” position and unplug the water heater from the wall outlet.
- Step 2. Turn off the cold water supply to the water heater. Connect a hose to the drain valve of the water heater and route to an open drain. Open a nearby hot water faucet to vent the water heater for draining. Open the drain valve of the water heater and allow the water heater to drain to a point below the outlet connection nipple.
- Step 3. Remove the caps with a slotted screwdriver or similar tool.
- Step 4. Remove the insulation to gain access to the hex head anode.
- Step 5. The hex head anode is approximately 4-1/4” below the jacket head. An extension and a deep 1-1/16” socket is necessary to loosen the anode.
- Step 6. Remove the anode and visually inspect the anode.
- Step 7. If the anode does show signs of depletion, this is normal.
 - a. If depletion is 1/2 of the original anode diameter (approximately 3/4” diameter), replacement is recommended.
 - b. If any of the steel core of the anode is exposed, replacement is recommended.
- Step 8. Upon completion of inspection or subsequent replacement, apply plumber’s tape to the threads and reinstall the hex head anode into the water heater. Put in place the insulation as best as possible to reduce heat loss and reapply the hole closure.
- Step 9. Repeat steps 4 through 8 for the second anode.
- Step 10. Resume the water supply and refill with water.
- Step 11. To resume operation, follow the instructions located on the lighting instruction label or the lighting instructions located in the Installation and Operation manual.



Flue Baffle Inspection & Replacement

Step 1. Position the gas control power switch to the "OFF" position and unplug the blower from the wall outlet.

Loosen hose clamps with 5/16" nutdriver

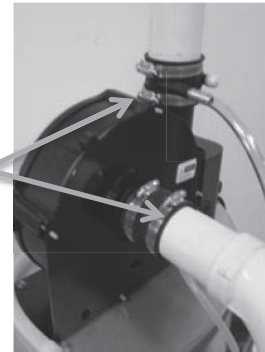

Step 2. Use a slotted screwdriver or 5/16" nutdriver to loosen the hose clamps connecting the venting to both the top and back of the blower. Disconnect tubing and both sets of venting from the blower.

Step 3. Disconnect the blower harness from the blower.

Step 4. Remove the two blower mounting screws with a 1/4" nut driver.

Disconnect blower harness

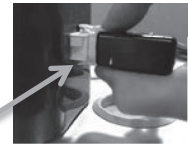

Step 5. Remove the blower from the water heater.

Step 6. Remove the two blower mounting screws with a 1/4" nut driver.

Step 7. Remove the blower from the water heater.

Step 8. Remove the jacket head screws with a 1/4" nutdriver. Remove the jacket head. This may require assistance with a slotted screwdriver as shown below.

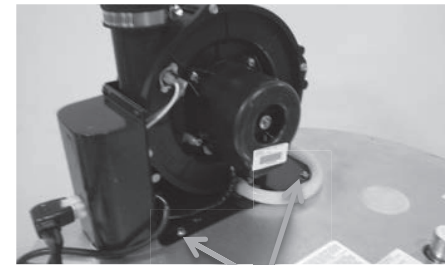

Unscrew 2 blower mounting screws with a 1/4" nutdriver.



Remove all 1/4" hex head screws around the jacket head flange.



Inserting slotted end of a screwdriver and applying force upward can assist in removing the jacket head.

Step 9. With the jacket head removed, cut the perimeter of the top piece of fiberglass insulation to peel back or remove and gain access to the flue collector.

Step 10. Remove the 11 screws sealing the top lid of the flue collector with a 1/4" nutdriver. Remove the flue collector lid to gain access to the flue core and baffles.



With the fiberglass insulation perimeter cut, it can be pulled back or taken off to provide access to 1/4" screws on the flue collector.

Condensing PV Series

PV SERVICE PROCEDURE XII Flue Baffle Inspection & Replacement

- Step 11. Remove the flue baffles and flue core from the water heater.
- Step 12. Inspect the baffles and flue core for deterioration. Clean any scale or debris build up. Replace with new baffles or flue core as necessary.
- Step 13. Reinstall the flue core into the water heater. Be sure that when reinstalling the baffles, they are oriented as shown below such that the top flat portion will form a small arc if connected. A slight reduction in efficiency will result otherwise.



Flat sections of baffles oriented to provide an arc when reinstalled properly.

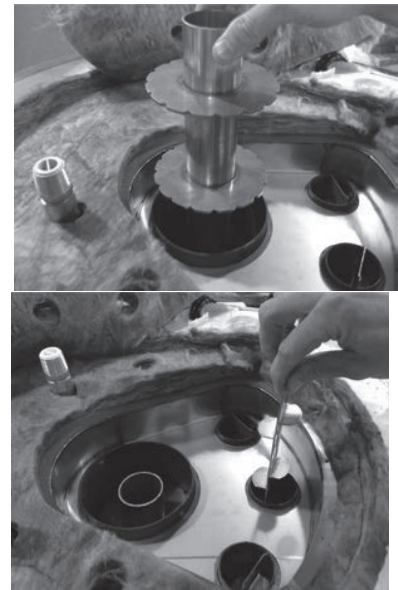

- Step 14. Review the seals around the flues to verify that the flue collector is in good working order.
- Step 15. Place the flue collector lid back on and screw in securely all 11 of the 1/4" head head screws. Refer to Step 9.
- Step 16. Return the insulation above the flue collector and apply the jacket head. Secure the jacket head in place by screwing in the 1/4" screws removed in Step 7.
- Step 17. Reinstall the blower on the jacket head. There are holes in the jacket head to accept locating pins on the underside of the blower housing. Screw the blower securely in place with the 2 screws removed in Step 5.
- Step 18. Connect the blower harness to the blower connector.
- Step 19. Connect the vertical vent pipe assembly to the side of the blower, securing it in place by tightening the hose clamp with a 5/16" nutdriver.
- Step 20. Connect the exhaust venting to the blower top, securing it in place by tightening the hose clamp with a 5/16" nutdriver.
- Step 21. Connect the tubing from the vertical vent pipe to the blower.
- Step 22. Verify all hose clamp connections are secure and tubing is connected.
- Step 23. Plug the water heater into the wall outlet.
- Step 24. To resume operation follow the lighting instruction located on the lighting instruction label or the lighting instruction located in the Installation & Operation manual.

Inner Door Removal Procedure

- Step 1. Position gas control power switch to the "OFF" position.
- Step 2. Remove outer jacket burner access door.
- Step 3. Inner Door removal.
- Remove (2) ¼" hex drive screws from right side inner door.
 - Remove (2) ¼" drive screws from flange section of inner door.
 - Remove (2) ¼" drive screws from left side inner door.
 - Remove inner door and inspect per step 4.

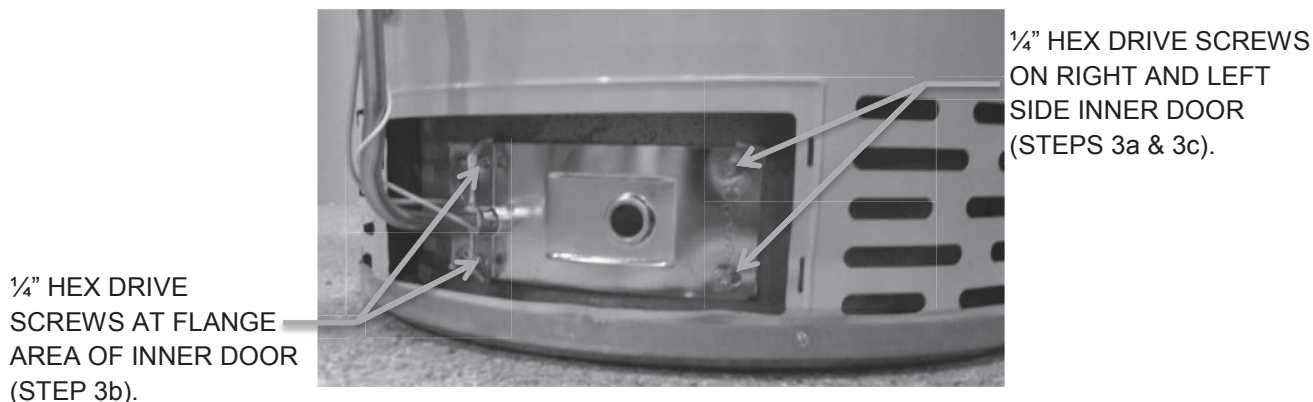

- Step 4. Fully inspect inner door gaskets for the following:
- Tears
 - Other imperfections that will inhibit proper seal
 - Missing Material
 - Gasket adhesion to inner door
 - Cracks
 - Material left on combustion chamber (around opening)
 - Dirt or debris

If the gasket is not affected by any of the above, gasket replacement is not required. If replacement is required, proceed to **Inner Door Gasket Replacement Procedure**.

Inner Door Gasket Replacement Procedure

⚠ WARNING

If the information in these instructions is not followed exactly, a fire or explosion may result causing property damage, personal injury or death.

- Step 5. After inspection of the inner door as noted in step 4, completely remove the gasket and adhesive residue from the right and left side inner doors as needed.
- Step 6. Use RTV sealant (recommended bead size 1/8") to secure the inner door gasket to the inner door sections (right & left). Refer to illustration on the next page for proper application. Note the overlap configuration in the flange area of the inner door. Set the flange section first. This will help to achieve the proper overlap position.

Installation of Inner Door With Gasket

- Step 7. Clean any residual gasket residue or other debris from the combustion chamber surface before installing the inner door/gasket assembly.
- Step 8. Place the left side inner door into position first. Firmly position the radiused channel of the inner door around the feedline. Using the ¼" hex drive screws from step 3c, secure the left side inner door in place. **DO NOT OVER TIGHTEN SCREWS.**
- Step 9. Position pilot tube and igniter/sensor wire against left side inner door flange gasket. **DO NOT ROUTE PILOT TUBE AND IGNITER/SENSOR WIRE THROUGH RADIUSED CHANNEL WITH THE FEEDLINE.**

⚠ WARNING

Stripped fastener connections may allow for seal breach of inner door. A seal breach may result in a fire or explosion causing property damage, personal injury or death. Do not over tighten screws in steps 8, 10 and 11.

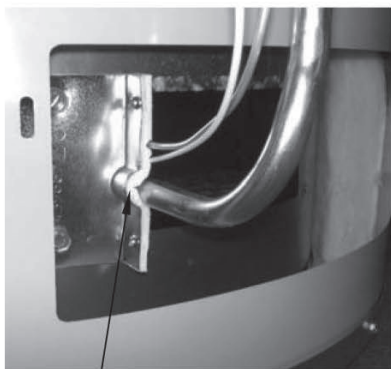

RADIUSED CHANNEL FOR FEEDLINE

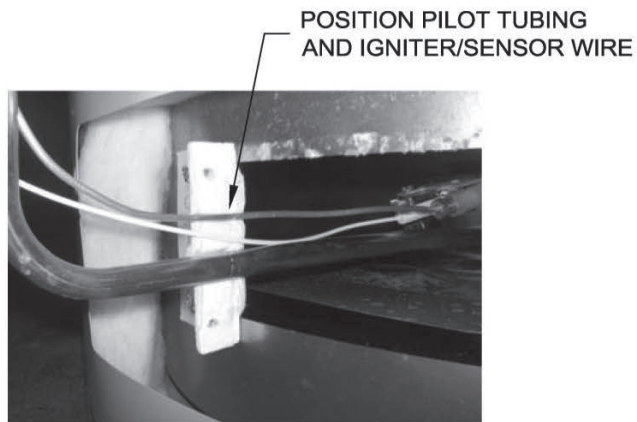

POSITION PILOT TUBING AND IGNITER/SENSOR WIRE

Installation of Inner Door With Gasket (cont.)

- Step 10. Firmly place right side inner door flange against the left side inner door flange and secure with (2) ¼" hex drive screws from step 3b. **DO NOT OVER TIGHTEN SCREWS.**
- Step 11. Align right side inner door to combustion chamber and verify the fastener holes of the combustion chamber are aligned with right side inner door slotted opening. Verify seal integrity around combustion opening. Secure right side inner door using ¼" hex drive screws from step 3a. **DO NOT OVER TIGHTEN SCREWS.** Verify both left and right sides of inner door are properly positioned and sealed against the combustion chamber.
- Step 12. Replace outer jacket burner access door.
- Step 13. To resume operation follow the instructions located on the lighting instruction label or the lighting instructions located in the Installation & Operation manual.

Condensate Trap Removal, Inspection & Replacement

The condensate trap has a self-priming trap that safely removes condensate from the water heater. If the condensate is not removed from the water heater, it will accumulate and eventually produce an error code. This condensate trap is field serviceable and can be removed for inspection if this condition exists.

- Step 1. Disconnect the clear tube that allows the condensate to come into the condensate tee from the exhaust and blower assembly.
- Step 2. Disconnect the mate to the condensate trap discharge. Note if water can flow through the condensate line attached to the condensate tee. If water cannot flow through the line, remove obstruction.
- Step 3. Loosen the hose clamps connecting the condensate tee to the back cover and the vertical vent pipe.
- Step 4. Remove the condensate tee. Be aware that condensate is in the tee and take appropriate measures.
- Step 5. Remove the bottom cap of the condensate tee and verify that there is no obstruction in the trap.
- Step 6. Return the trap into service. Secure the bottom cap by screwing it in place.
- Step 7. Position the condensate back in place, securing the hose clamps on the cover neck and the vertical vent pipe assembly.
- Step 8. Connect the condensate discharge to the trap.
- Step 9. Connect the clear tube from the exhaust and blower assembly to the condensate trap.
- Step 10. Return the water heater into operation, following the instructions located on the lighting instruction label or the lighting instructions located in the Installation and Operation manual.

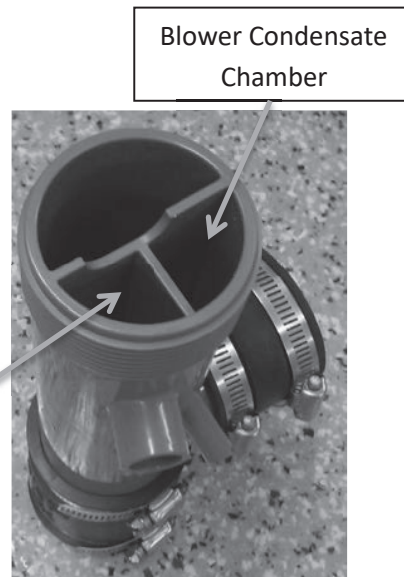
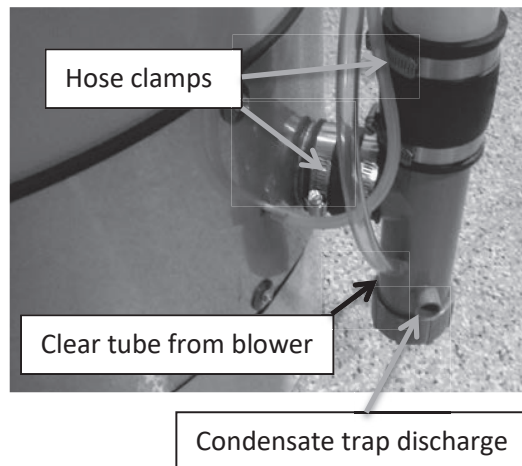

Verify no debris is obstructing condensate from entering Condensate Discharge Chamber

Exhaust Collector Removal, Inspection & Replacement

The Exhaust Collector Gasket seals around the secondary flue tubes and between the jacket and the collector cover. This seal allows the exhaust to be concentrated into a single exhaust port and allows a passageway for the condensate to flow into the trap.

If condensate is dripping from the seal or if a measured reduction in blower pressure is observed, the gasket may need inspection. To do this, follow the steps listed below.

1. Loosen the hose clamp connecting the condensate tee to the exhaust cover.
2. Remove the ¼" clear hose from the port on the exhaust cover.
3. With a 5/16" socket or wrench, loosen the 8 screws sealing the cover to the gasket.
4. Remove the cover and inspect the seal bead on the gasket flange as well as the seal around the secondary flue tubes. Inspect the gasket to make sure there are no cuts or openings in the balance of the gasket body.

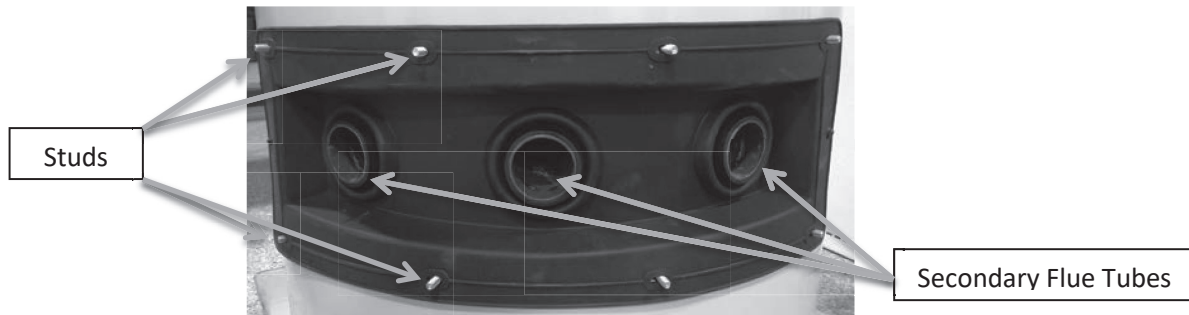
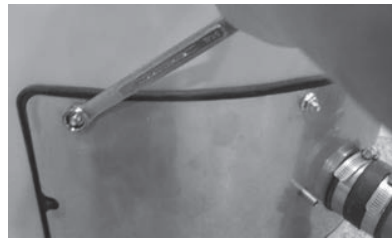

5. If the gasket requires replacement, follow the steps below:
 - a. Remove the gasket from the studs extending through the jacket. The gasket flange should be aligned such that the studs extend through the flange holes.
 - b. Pull the gasket off the secondary flue tubes.
 - c. Replace the gasket with the new gasket by first pushing the gasket over the secondary flue tubes. This can be done by hand and should be pushed over the secondary flue discharge such that the neck of the opening should be flush with the end of the secondary flue tube.



Condensing PV Series

PV SERVICE PROCEDURE XV Exhaust Collector Removal, Inspection & Replacement

- d. Align the gasket flange holes to go over the studs extending through the jacket. After verifying that the studs are through the flange holes and that the gasket is sealed around the secondary flue tubes, return the cover such that the studs extend through the openings.



- e. Hand start the nuts that were removed in step 3 onto the studs on all 8 locations to ensure a proper fit. Begin securing the 5/16" nuts with a wrench or a socket. This process should be done following the diagram below. Each flange nut should be tightened to 25 in*lbs.

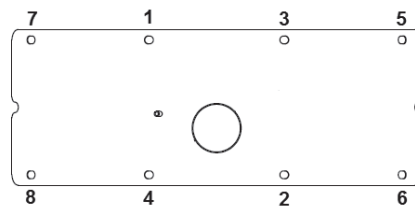

6. Once all the flange nuts are back in place, reconnect the 1/4" clear tubing onto the port on the cover.
7. Connect the condensate tee and coupler to the neck provided on the cover and secure by tightening the hose clamp.

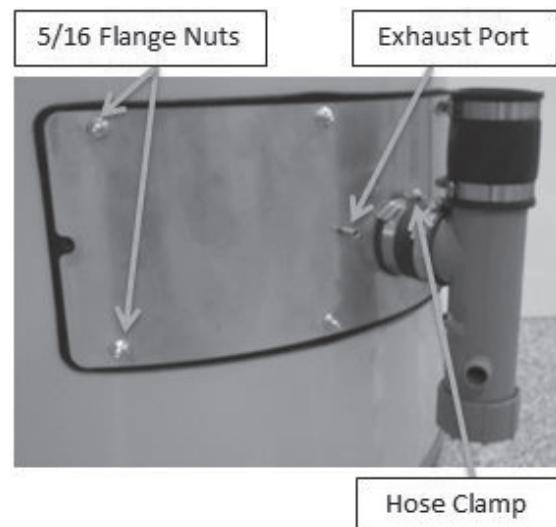

Condensing PV Series

PARTS LIST

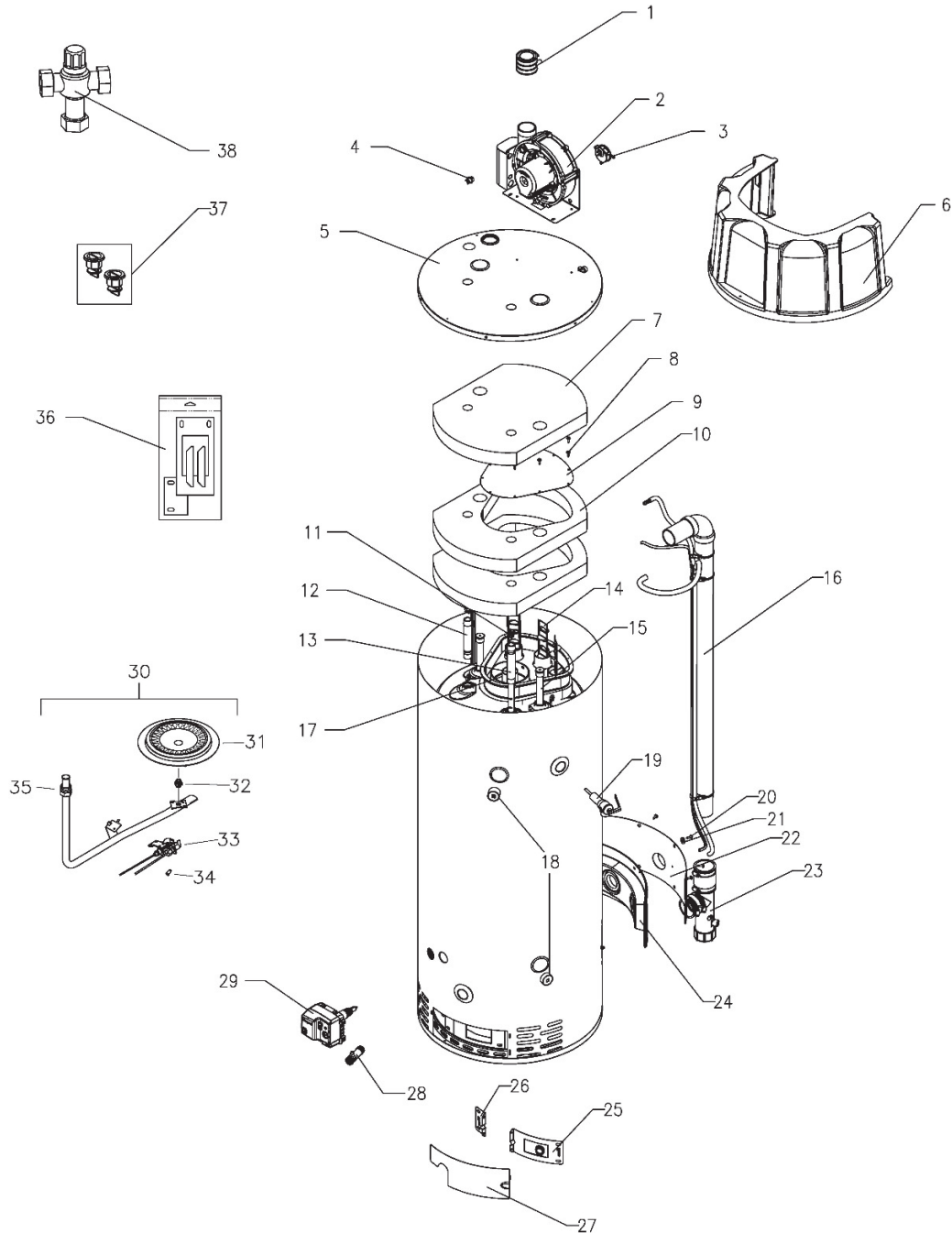

- | | | | |
|---------------------------|------------------------|---------------------------|--------------------------------|
| 1. Exhaust Adapter | 11. Heat Trap Insert | 21. Washer | 31. Burner |
| 2. Blower | 12. Hot Water Outlet | 22. Exhaust Cover | 32. Orifice |
| 3. Pressure Switch | 13. Inlet Diptube | 23. Condensate Tee | 33. Pilot |
| 4. Blower Temp. Switch | 14. Flue Baffle | 24. Exhaust Gasket | 34. Screw |
| 5. Jacket Head | 15. Hex Head Anode | 25. Right Side Inner Door | 35. Feedline |
| 6. Surround | 16. Vertical Vent Pipe | 26. Left Side Inner Door | 36. Inner Door Gasket |
| 7. Jacket Head Insulation | 17. Flue Core | 27. Outer Door | 37. Heat Trap Kit |
| 8. Collector Screw | 18. 3/4 NPT Plug | 28. Drain Valve | 38. ASSE Approved Mixing Valve |
| 9. Flue Collector Cover | 19. T & P Valve | 29. Gas Valve | |
| 10. Collector Insulation | 20. Screw | 30. Burner Assembly | |



BRADFORD WHITE®

W A T E R H E A T E R S

Ambler, PA

For U.S. and Canada field service,
contact your professional installer or
local Bradford White sales representative.

Sales/800-523-2931

Technical Support/800-334-3393
Email/techserv@bradfordwhite.com

Warranty/800-531-2111
Email/warranty@bradfordwhite.com

Service Parts/800-538-2020
Email/Parts@bradfordwhite.com

International:
international@bradfordwhite.com



BRADFORD WHITE™

CANADA

Halton Hills, Ontario, Canada

Sales & Technical Support/866-690-0961
905-203-0600

Fax/905-636-0666

Email

Warranty/bwccwarranty@bradfordwhite.com
Technical Support/BWCCTech@bradfordwhite.com
Parts/orders@bradfordwhitecanada.com
Orders/ca.orders@bradfordwhite.com

www.bradfordwhite.com