

ELECTRIC WATER HEATER

INSTALLATION & OPERATING INSTRUCTION MANUAL

THE MANUFACTURER OF THIS HEATER WILL NOT BE LIABLE FOR ANY DAMAGE RESULTING FROM FAILURE TO COMPLY WITH THESE INSTRUCTIONS. READ THESE INSTRUCTIONS THOROUGHLY BEFORE STARTING.

For safety, convenience, and best performance, we recommend this water heater be installed and serviced by a plumbing professional.

TABLE OF CONTENTS

General Information	3
Installation	4
Locating The Water Heater	4
Water Connections	6
Electrical Connections	11
Amperage Chart	12
GPH Recovery Capacities	12
General Operation	13
Thermostat Adjustment	14
Maintenance	15
Notes	18

CONGRATULATIONS!

You have just purchased one of the finest water heaters on the market today!

This installation, operation and instruction manual will explain in detail the installation and maintenance of your new Electric Water Heater. We strongly recommend that you contact a plumbing professional for the installation of this water heater.

We require that you carefully read this manual, as well as the enclosed warranty, and refer to it when questions arise. If you have any specific questions concerning your warranty, please consult the plumbing professional from whom your water heater was purchased. For your records we recommend that you write the model, serial number and installation date of your water heater in the maintenance section in the back of this manual.

This manual should be kept with the water heater.

GENERAL INFORMATION

This water heater must be installed in accordance with local codes. In the absence of local codes, install this water heater in accordance with national or regional requirements.

The best efficiency and longest product life is obtained only when the water heater is installed, adjusted and operated in accordance with these Installation and Operating Instructions. The manufacturer will not be held liable for damage resulting from alteration and/or failure to comply with these instructions.

This water heater has been designed and listed for the purpose of heating potable water. The installation and use of this water heater for any purpose other than the heating of potable water may cause damage to the water heater and create a hazardous condition.

CAUTION

Incorrect operation of this appliance may create a hazard to life and property and may impair and shorten heater life.

Do not use this appliance if any part has been under water. Immediately call a qualified service technician to inspect the appliance and to replace any part of the control system which has been under water. Depending upon individual circumstances, it may be necessary to replace the entire water heater.

Make sure that the voltage being supplied to the water heater is according to the voltage printed on the product rating plate.

DANGER

Do not store or use gasoline or other flammable, combustible or corrosive vapors and liquids in the vicinity of this or any other appliance.

IMPORTANT

Before proceeding, please inspect the water heater and its components for possible damage. DO NOT install any damaged components. If damage is evident, please contact the supplier where the water heater was purchased or the manufacturer listed on the rating plate for replacement parts.

General Information continued-

A sacrificial anode(s) is used to extend tank life. Removal of any anode, for any reason, will shorten the products useful life. In areas where water is unusually active, an odor may occur at the hot water faucet due to a reaction between the sacrificial anode and impurities in the water. If this should happen, an alternative anode(s) may be purchased from the supplier that installed this water heater. This will minimize the odor while protecting the tank. Additionally, the water heater should be flushed with appropriate dissolvers to eliminate any bacteria.

INSTALLATION

Locating The Water Heater

▲ WARNING

Water heaters are heat-producing appliances. To avoid damage or injury, there must be no materials stored against the water heater and proper care must be taken to avoid unnecessary contact (especially by children) with the water heater. **UNDER NO CIRCUMSTANCES SHALL FLAMMABLE MATERIALS, SUCH AS GASOLINE OR PAINT THINNER BE USED OR STORED IN THE VICINITY OF THIS WATER HEATER OR ANY LOCATION FROM WHICH FUMES COULD REACH THE WATER HEATER.**

This water heater must NOT be installed in any location where gasoline or flammable vapors are likely to be present, unless the installation is such to eliminate the ignition of gasoline or flammable vapors.

The location where this water heater is to be installed will be of utmost importance. Before installing this water heater, consult the installation section of these instructions. After reading these installation and operating instructions, select a location for the water heater where the floor is level and where the power supply and water connections are easily accessible. It is recommended that the water heater be located near the center of greatest hot water usage to reduce heat loss from the pipes.

DO NOT locate the water heater where water lines could be subjected to freezing temperatures. Locate the water heater so that access panels and drain valves are accessible.

Locating The Water Heater continued-

Water heater corrosion and component failure can be caused by the heating and breakdown of airborne chemical vapors. Examples of some typical compounds that are potentially corrosive are: spray can propellants, cleaning solvents, refrigerator and air conditioning refrigerants, swimming pool chemicals, calcium or sodium chloride, waxes and process chemicals. These materials are corrosive at very low concentration levels with little or no odor to reveal their presence.

NOTE: THE MANUFACTURER OF THIS WATER HEATER WILL NOT ACCEPT RESPONSIBILITY FOR DAMAGE TO THE WATER HEATER CAUSED BY EXPOSURE TO CORROSIVE VAPORS. DO NOT OPERATE THE WATER HEATER IF EXPOSURE HAS OR WILL OCCUR. DO NOT STORE ANY POTENTIALLY CORROSIVE COMPOUNDS IN THE VICINITY OF THE WATER HEATER.

This water heater must be located in an area where leakage of the tank or water line connections and the combination temperature and pressure relief valve will not result in damage to the area adjacent to the water heater or to lower floors of the structure. When such locations cannot be avoided, a suitable drain pan must be installed under the water heater. The drain pan must have a minimum length and width of at least 4 in. (10.2 cm) greater than the diameter of the water heater. The drain pan, as described above, can be purchased from your plumbing professional. The drain pan must be piped to an adequate drain. The piping must be pitched for proper drainage.

This water heater MUST be installed indoors out of the wind and weather.

Note: For California installation this water heater must be braced, anchored, or strapped to avoid falling or moving during an earthquake. See instructions for correct installation procedures. Instructions may be obtained from the DSA Headquarters Office, 1102 Q Street, Suite 5100, Sacramento, CA 95811.

Water Connections

NOTE: BEFORE PROCEEDING WITH THE INSTALLATION, CLOSE THE MAIN WATER SUPPLY VALVE.

After shutting the main water supply valve, open a faucet to relieve the water line pressure to prevent any water from leaking out of the pipes while making the water connections to the water heater. After the pressure has been relieved, close the faucet. The cold water inlet line connects to the inlet nipple at the base of the water heater. The hot water outlet line connects to the nipple on top of the water heater. The fittings at the cold water inlet and hot water outlet are dielectric waterway fittings with tapered male threads. Make the proper plumbing connections between the water heater and the plumbing system in the structure. Install a shut-off valve in the cold water supply line.

CAUTION

If sweat fittings are to be used, **DO NOT** apply heat to the nipples on top of the water heater. Sweat the tubing to the adapter before fitting the adapter to the water connections. It is imperative that heat is not applied to the nipples containing a plastic liner.

IMPORTANT

FAILURE TO INSTALL AND MAINTAIN A NEW, LISTED TEMPERATURE-PRESSURE RELIEF VALVE WILL RELEASE THE MANUFACTURER FROM ANY CLAIM, WHICH MIGHT RESULT FROM EXCESSIVE TEMPERATURE AND PRESSURES.

If this water heater is installed in a closed water supply system, such as one having a back-flow preventer in the cold water supply, provisions shall be made to control thermal expansion. **DO NOT** operate this water heater in a closed system without provisions for controlling thermal expansion. Your water supplier or local plumbing inspector should be contacted about how to control this situation.

After installation of the water lines, open the main water supply valve and fill the water heater. While the water heater is filling, open several hot water faucets to allow air to escape from the water system. After a steady stream of water flows from the faucets, close them and check all water connections for possible leaks. **NEVER OPERATE THE WATER HEATER WITHOUT FIRST BEING CERTAIN IT IS FILLED WITH WATER.**

▲ WARNING

For protection against excessive temperatures and pressure, install temperature and pressure protective equipment required by local codes, but not less than a combination temperature and pressure relief valve certified by a nationally recognized testing laboratory that maintains periodic inspection of production of listed equipment or materials, as meeting the Requirements for *Relief Valves and Automatic Gas Shutoff Devices for Hot Water Supply Systems, ANSI Z21.22*, and the Standard *CAN1-4.4 Temperature, Pressure, Temperature and Pressure Relief Valves and Vacuum Relief Valves*. The combination temperature and pressure relief valve must be marked with a maximum set pressure, not to exceed the maximum working pressure of the water heater. The combination temperature and pressure relief valve shall also have an hourly rated temperature steam BTU discharge capacity not less than the hourly input rating of the water heater.

Install the combination temperature and pressure relief valve into the opening provided and marked for this purpose on the water heater

Note: Some models may already be equipped or supplied with a combination temperature and pressure relief valve. Verify that the combination temperature and pressure relief valve complies with local codes. If the combination temperature and pressure relief valve does not comply with local codes, replace it with one that does. Follow the installation instructions above on this page.

Install a discharge line so that water discharged from the combination temperature and pressure relief valve will exit within six (6) inches (15.3 cm) above, or any distance below the structural floor and cannot contact any live electrical part. The discharge line is to be installed to allow for complete drainage of both the temperature and pressure relief valve and the discharge line. The discharge opening must not be subjected to blockage or freezing. **DO NOT** thread, plug or cap the discharge line. It is recommended that a minimum of four (4) inches (10.2 cm) be provided on the side of the water heater for servicing and maintenance of the combination temperature and pressure relief valve.

Do not place a valve between the combination temperature and pressure relief valve and the tank.

⚠ WARNING

Hydrogen gas can be produced in a hot water system served by this water heater that has not been used for a long period of time (generally two weeks or more). Hydrogen gas is extremely flammable. To reduce the risk of injury under these conditions, it is recommended that the hot water faucet be opened for several minutes at the kitchen sink before using any electrical appliance connected to the hot water system. If hydrogen is present, there will probably be an unusual sound such as air escaping through the pipe as the water begins to flow. There should be no smoking or open flame near the faucet at the time it is open.

⚠ CAUTION

INCREASING THE THERMOSTAT SETTING ABOVE THE PRESET TEMPERATURE MAY CAUSE SEVERE BURNS AND CONSUME EXCESSIVE ENERGY. HOTTER WATER INCREASES THE RISK OF SCALD INJURY.

This water heater can deliver scalding temperature water at any faucet in the system. Be careful whenever using hot water to avoid scalding injury. Certain appliances, such as dishwashers and automatic clothes washers, may require increased temperature water. By setting the thermostat on this water heater to obtain increased temperature water required by these appliances, you might create the potential for scald injury. To protect against injury, you should install an ASSE approved mixing valve in the water system. This valve will reduce point of discharge temperature by mixing cold and hot water in branch supply lines. Such valves are available from the manufacturer of this water heater or a local plumbing supplier. Please consult with a plumbing professional.

Water Connections continued-

	<p>Water temperature over 125°F (52°C) can cause severe burns instantly or death from scalds.</p> <p>Children, disabled and elderly are at highest risk of being scalded.</p> <p>Review this instruction manual before setting temperature at water heater.</p> <p>Feel water before bathing or showering.</p> <p>Temperature limiting valves are available.</p>
---	--

APPROXIMATE TIME/TEMPERATURE RELATIONSHIPS IN SCALDS	
120°F (49°C)	More than 5 minutes
125°F (52°C)	1½ to 2 minutes
130°F (54°C)	About 30 seconds
135°F (57°C)	About 10 seconds
140°F (60°C)	Less than 5 seconds
145°F (63°C)	Less than 3 seconds
150°F (66°C)	About 1½ seconds
155°F (68°C)	About 1 second

Water Connections continued-

The hot and cold water connections are identified on the top of the water heater. Connect the hot and cold water lines to the installed nipples using unions. Install a listed temperature-pressure relief valve in the opening on the top of the water heater.

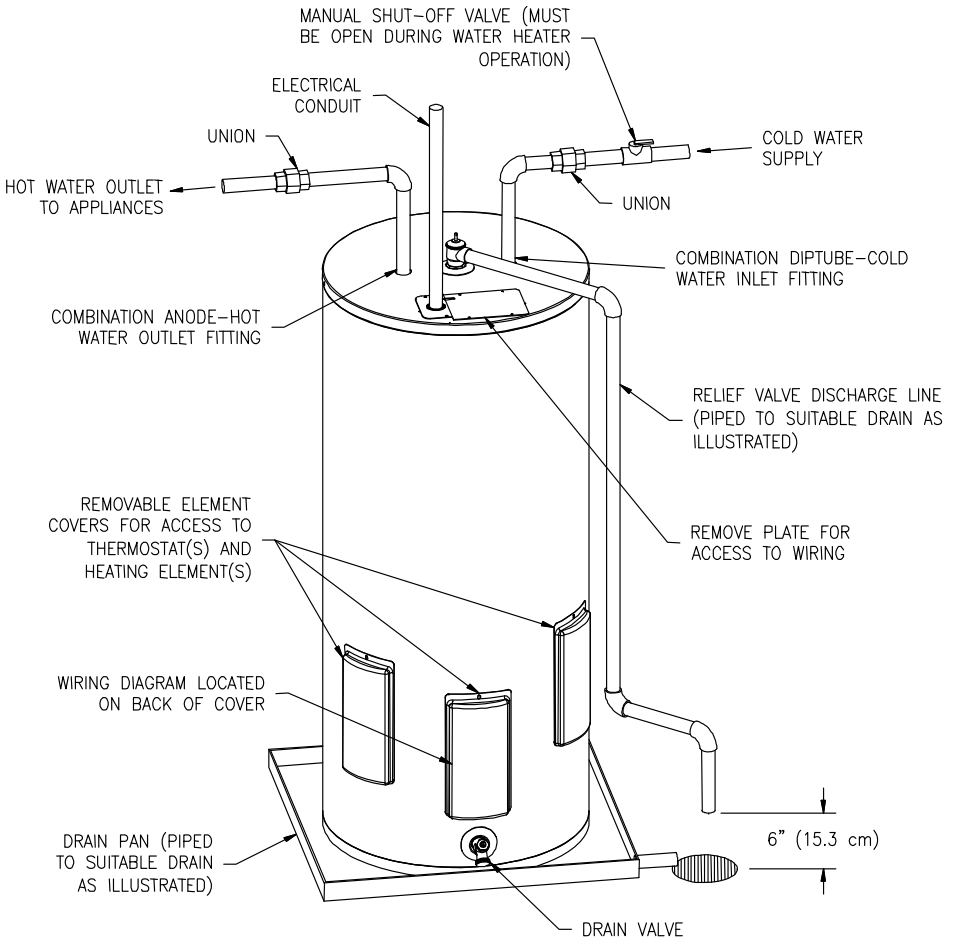

Figure 1

Electrical Connections

Before any electrical connections are made, be sure the water heater is full of water and the manual shut-off valve located in the cold water supply line is open. If the heating elements are not completely immersed in water at all times, they will be damaged (burned-out) if energized for even a short period of time. There is no warranty for burned-out heating elements. Before proceeding verify a correct electrical connection has been made by checking the rating plate and wiring diagram. The temperature-limiting device is of the manual reset, trip-free type and has been factory installed to interrupt all ungrounded power supply conductors in the event of thermostat failure.

The plumbing supplier in your area ordered this water heater wired at the factory to comply with existing area codes, but local utility codes may require or allow other circuitry. Consult your local power company to determine the correct electrical hook-up in order to meet local utility and building codes and in order to obtain the most economical rates. All electrical connections to elements, thermostats, and terminal block have been made at the factory. **DO NOT** alter any of the internal wiring. Wiring connections may loosen during shipment. Check all connections for tightness.

To make the wiring connections to a power supply, follow the steps below.

- A) Remove the control box cover panel.
- B) Bring the power leads from an adequately sized fused disconnect switch (not furnished with the water heater due to varying state and local codes) and connect to the terminal block. Consult your local code and/or utility authority about the correct wire size for the length of the wire required in this installation. Longer wire lengths will usually require larger wire size.
- C) This water heater must be properly grounded. A ground connection is provided for connection to a properly sized ground. (See wiring diagram for minimum required ground size. Wiring diagram is located on the inside of the element cover)
- D) Replace the control box cover panel.

Heating Elements

To replace heating elements, disconnect power to the water heater, drain tank and replace element. To remove a heating element, use a 1 1/2" screw type element wrench that is usually available at places where plumbing supplies can be obtained. **Do not** over-tighten the new element, as this will cause distortion in the new element gasket. Once the element has been replaced, follow the instructions "To Fill The Water Heater". It is imperative that the water heater is filled with water before the power is restored to the heating elements.

Amperage Chart

kW Input	Amperage			Fuse Size			Ground Wire Size		
	220V	380V	415V	220V	380V	415V	(AWG)		
	1Ø	3Ø	3Ø	1Ø	3Ø	3Ø	220V	380V	415V
6	27	9	8	35	12	10	10	14	14
9	41	14	13	60	20	20	10	14	14
12	55	18	17	70	25	25	8	12	12
13.5	61	21	19	80	30	25	8	10	12
15	68	23	21	90	30	30	8	10	10
16.5	75	25	23	100	35	30	8	10	10
18	82	27	25	110	35	35	8	10	10

GPH Recovery Capacities

kW Input	Temperature Rise									
	40°F	50°F	60°F	70°F	80°F	90°F	100°F	120°F	130°F	140°F
6	62	50	41	35	31	28	25	21	19	18
9	93	74	62	53	47	41	37	31	29	27
12	124	99	83	71	62	55	50	41	38	35
13.5	140	112	93	80	70	62	56	47	43	40
15	155	125	103	89	78	69	62	52	48	44
16.5	171	137	114	98	86	76	68	57	53	49
18	186	149	124	106	93	83	74	62	57	53

Multiply kW input by 3,412 to determine BTU input:

Example: 54kW x 3412 = 184,248 BTU's

Recovery Computation Formula

$$GPH = (\text{watts} \times 3.412) / (8.25 \times \text{°Temp. Rise})$$

GENERAL OPERATION

Before closing the switch to allow electric current to flow to the water heater, make certain that the water heater is full of water and that the cold water inlet valve is open. Complete failure of the heating element(s) will result if they are not totally immersed in water at all times. Failure of the element(s) due to dry-firing is not covered by warranty.

When the switch is closed, the operation of this electric water heater is automatic. The water heater thermostat(s) are preset to the "HOT" setting to provide a water temperature of approximately 140°F (60°C) or below in order to reduce the risk of scald injury. Care must be taken whenever using hot water to avoid scalding injury. Certain appliances require high temperature hot water (such as dishwashers and automatic clothes washers).

CAUTION

Scalding may occur within five (5) seconds at a temperature setting of 140°F (60°C).

TO FILL THE WATER HEATER

1. Close the water heater drain valve by turning the knob clockwise.
2. Open the cold water supply shut-off valve.
3. Open several hot water faucets to allow air to escape from the system.
4. When a steady stream of water flows from the faucets, the water heater is filled. Close the faucets and check for water leaks at the water heater drain valve, combination temperature and pressure relief valve and the hot and cold water connections.
5. Reconnect power supply to water heater.

TO DRAIN THE HEATER

Should it become necessary to completely drain the water heater, make sure you follow the steps below:

1. Disconnect the power supply to the heater. Consult the plumbing professional or electric company in your area for service.
2. Close the cold water supply shut-off valve.
3. Open the drain valve on the water heater by turning the knob counter-clockwise. The drain valve has threads on the end that will allow connection of a standard hose coupling.
4. Open a hot water faucet to allow air to enter the system.

To refill the water heater, refer to "TO FILL THE WATER HEATER."

Thermostat Adjustment

⚠ CAUTION

Before adjusting thermostat(s), turn off power supply to the water heater.

The temperature of the water can be changed by adjusting the thermostat(s). Before any work is done on the water heater, disconnect all power to the water heater by opening the switch at the main electrical circuit breaker or fuse box. Remove the access panels and fold the insulation outward away from the controls. Set the thermostat(s) to the desired water temperature by using a screwdriver to move the thermostat dial. The thermostat has been factory preset to approximately 140°F (60°C) or below. Rotate the temperature dial clockwise to increase water temperature. Replace the insulation making sure the controls are well covered and the plastic terminal shield has not been displaced; replace the access panel. The water heater is now ready for operation and the main switch can be closed.

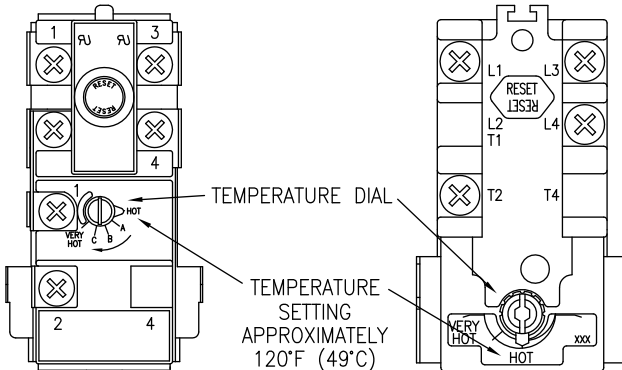

Figure 2

⚠ DANGER

Hotter water increases the risk of scald injury. Scalding may occur within five (5) seconds at a temperature setting of 140°F (60°C). To protect against hot water injury, install an ASSE approved mixing valve in the water system. This valve will reduce point of discharge water temperatures by mixing cold and hot water in branch water lines. A licensed plumbing professional or local plumbing authority should be consulted.

Note: This water heater is equipped with an energy cut out device to prevent overheating. Should overheating occur, turn off the electrical supply to the water heater and contact a qualified service technician.

MAINTENANCE

IMPORTANT

The water heater should be inspected at a minimum of annually by a qualified service technician for damaged components. **DO NOT** operate this water heater if any part is found damaged.

Shut off the electric power whenever the water supply to the water heater is off. Shut off the electric power and water supply, drain the heater completely to prevent freezing whenever the building is left unoccupied during the cold weather months. In order to insure efficient operation and long tank life, drain the water heater at least once a month through the drain valve until the water runs clear. Failure to do this may result in noisy operation and lime and sediment buildup in the bottom of the tank. Check the temperature-pressure relief valve to insure that the valve has not become encrusted with lime. Lift the lever at the top of the valve several times until the valve operates freely and seats properly without leaking.

WARNING

When lifting lever of temperature-pressure relief valve, hot water will be released under pressure. Be certain that any released water does not result in bodily injury or property damage. The magnesium anode rod should be inspected periodically and replaced when necessary to prolong tank life.

The following, maintenance should be performed by a qualified service technician at the minimum periodic intervals suggested below. In some installations, the maintenance interval may be more frequent depending on the amount of use and the operating conditions of the water heater. Regular inspection and maintenance of the water heater will help to insure safe and reliable operation.

1. Annually, check the operation of the thermostat(s).
2. Bi-annually, check the seal around the heating elements for leaks. If there is any sign of leaking, disconnect the power supply to the water heater and contact the plumbing professional that installed this water heater or a qualified service technician.

Maintenance continued-

3. At least once a year, check the combination temperature and pressure relief valve to insure that the valve has not become encrusted with lime. Lift the lever at the top of the temperature-pressure relief valve several times until the valve seats properly without leaking and operates freely.

▲ WARNING

When lifting lever of temperature-pressure relief valve, hot water will be released under pressure. Be certain that any released water does not result in bodily injury or property damage.

4. If the combination temperature and pressure relief valve on the appliance discharges periodically, this may be due to thermal expansion in a closed water supply system. Contact the water supplier or local plumbing inspector on how to correct this situation. **Do not plug the combination temperature and pressure relief valve outlet for any reason.**
5. Monthly, drain off a gallon of water from the water heater to remove silt and sediment.

▲ WARNING! THIS WATER MAY BE HOT.

6. A combination sacrificial anode rod/hot water outlet nipple has been installed to extend tank life. The anode rod should be inspected periodically (every 2 years) and replaced when necessary to prolong tank life. Water conditions in your area will influence the time interval for inspection and replacement of the anode rod. Contact the plumbing professional who installed the water heater or the manufacturer listed on the rating plate for anode replacement information. The use of a water softener may increase the speed of anode consumption. More frequent inspection of the anode is needed when using softened (or phosphate treated) water.

▲ CAUTION

FOR YOUR SAFETY, **DO NOT** ATTEMPT TO REPAIR THERMOSTAT(S), HEATING ELEMENTS, OR ELECTRICAL WIRING. REFER SUCH REPAIRS TO A QUALIFIED SERVICE TECHNICIAN.

Maintenance continued-

Contact your local plumbing supplier or plumbing professional for replacement parts or contact the company at the address displayed on the rating plate of the water heater.

For faster and better service, please provide the part name, model, and serial number(s) of the water heater(s) when ordering parts.

Manufactured under one or more of the following U.S. Patents: RE.34,534; B1 5,341,770; 4,416,222; 4,628,184; 4,669,448; 4,672,919; 4,808,356; 4,829,983; 4,861,968; 4,904,428; 5,000,893; 5,023,031; 5,052,346; 5,081,696; 5,092,519; 5,115,767; 5,199,385; 5,277,171; 5,372,185; 5,485,879; 5,574,822; 5,596,952; 5,660,165; 5,682,666; 5,761,379; 5,943,984; 5,954,492; 5,988,117; 6,142,216; 6,684,821; 7,063,132; 7,007,748; Other U.S. and Foreign patent applications pending. Current Canadian Patents: 1,272,914; 1,280,043; 1,289,832; 2,045,862; 2,092,105; 2,107,012; 2,108,186; 2,112,515.

Complete the following information and retain for future reference:

Model No: _____

Serial No: _____

Service Phone
Days: _____ Nights: _____

Address: _____

Supplier: _____

Supplier Phone No: _____

NOTES



**COMMERCIAL ELECTRIC ENERGY SAVER
MEDIUM DUTY E32 SERIES MODELS**

**SERVICE
MANUAL**

**Troubleshooting Guide
and Instructions for Service**
(To be performed ONLY by qualified service providers)

**For Bradford White
Model Series:**

Commercial Electric Energy Saver:
E32-50S
E32-80R
E32-120R

Table of Contents

	<u>Page</u>	<u>Service Procedure</u>
Introduction	2	---
Tools.....	2	---
General Information	3	---
Sequence of Operation	5	---
Field Conversion of kW, Voltage and Phase.....	6	---
Troubleshooting	9	---
Heating Element Testing	11	E32-I
Line Voltage Testing.....	12	E32-II
Fuse and ECO Testing.....	13	E32-III
Thermostat Operation Testing	14	E32-IV
Thermostat Removal and Replacement	15	E32-V
Heating Element Removal and Replacement	16	E32-VI
Dip Tube and Anode Inspection and Replacement	17	E32-VII
Generic Parts List	18	---

Introduction

This service manual is designed to aid service and maintenance professionals on the function, proper diagnosis and repair of Bradford White medium duty commercial electric water heaters.

The text and illustrations in this manual provide step by step instructions to facilitate proper operation and troubleshooting procedures. Contact the Bradford White Technical Support Group immediately if diagnosis can not be made using the methods described in this service manual.

Tools

- Multi Meter.
 - Phillips Head Screw Driver.
 - 1-½ Deep Well Socket (element removal).
 - Thermometer.
 - ¼" Nut Driver.
 - Drain Hose.
- Various Hand Tools: Pipe Wrench, Channel Locks, Pliers (common & needle nose), Wire cutters, Wire Strippers, Flash Light.

Commonly Used Formulas

Amps = $\frac{\text{Watts}}{\text{Volts}}$ (for single phase units) Example $4500\text{W}/240\text{V} = 18.75\text{A}$

Amps = $\frac{\text{Watts}}{\text{Volts} \times 1.732}$ (for balanced 3 phase units) Example $4500\text{W}/240\text{V} \times 1.732 = 10.82\text{A}$

Watts = Amps x Volts Example $18.75\text{A} \times 240\text{V} = 4500\text{W}$

Ohms = $\frac{\text{Volts}^2}{\text{Watts}}$ Example $(240\text{V})^2 / 4500\text{W} = 12.8 \text{ Ohms}$

Common Service Wire Configurations 240 VOLT

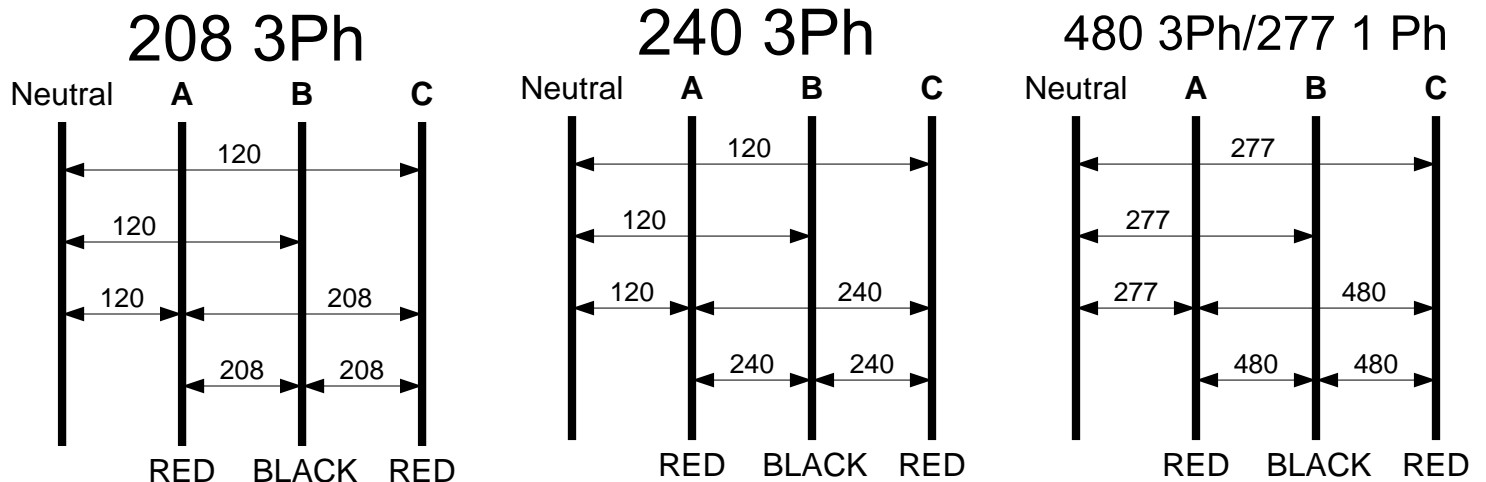
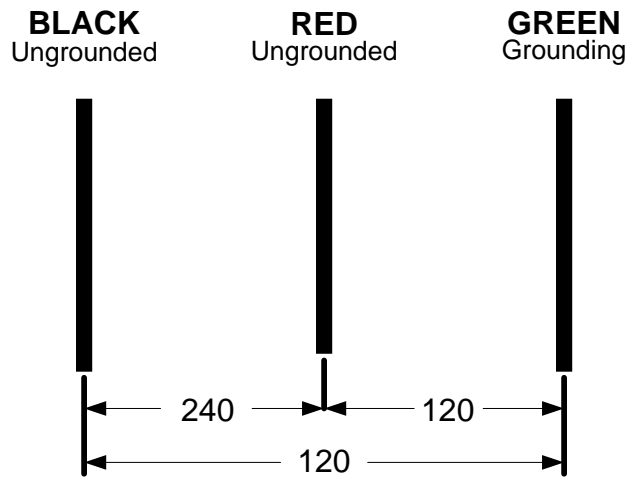

Full Load Amperes-(Phase 1/Phase 3)

<u>Input Kw</u>	<u>208V</u>	<u>240V</u>	<u>277V</u>	<u>380V</u>	<u>415V</u>	<u>480V</u>
6	28.8/16.6	25/14.4	21.6	10	8.3	12.5/7.2
9	43.2/25	37.5/21.6	32.4	14	12.5	18.7/10.8
12	57.6/33.3	50/28.9	43.3	19	16.7	25/14.4
13.5	64.9/37.5	56.2/32.5	48.7	21	18.8	28.1/16.2
15	72.1/37.5	62.5/36.1	54.1	23	20.9	31.2/18
18	86.5/50	75/43.4	64	28	25	37.5/21.6

Surface Mounted Thermostats

E32 series medium duty commercial water heaters use only surface mounted thermostats. Surface mounted thermostats are mounted into a bracket which holds the thermostat against the side of the tank. Surface mounted thermostats respond to tank surface temperatures to sense a call for heat, set point temperature settings and high limit (ECO) activation. It is important that the entire back surface of the thermostat is in full contact or flush with the tank. An improperly mounted thermostat will lead to improper heater operation.

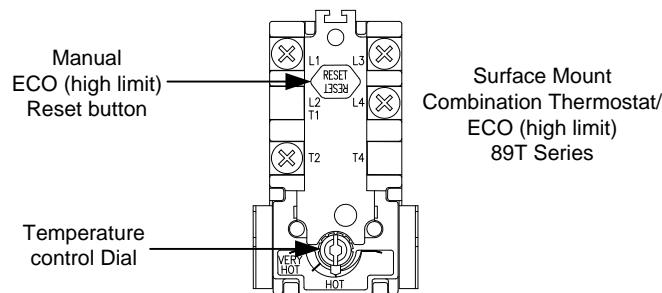

Direct Immersion “Screw-in” Type Heating Element

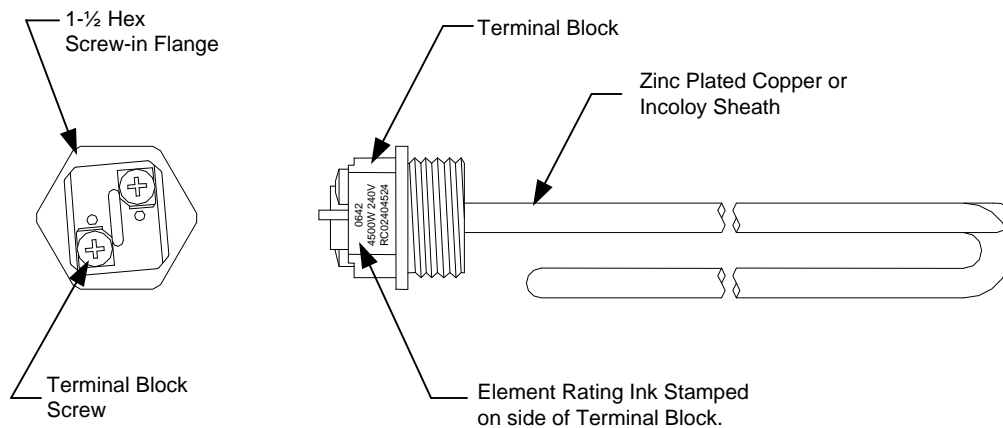

E32 series medium duty, field convertible commercial electric water heaters are designed to operate using single phase or three phase service connections. One size fits all Internal fusing is factory installed for all units. When field conversions are required, no fuse change is necessary. Three surface mounted thermostats operating independently are used to control a corresponding heating element.

Sequence of Operation.

- 1 **Single phase** line voltage is applied across terminals L1 and L2 of terminal block. Or **Three phase** line voltage is applied to terminals L1 through L3 of terminal block. Line voltage continues through terminal block and fuse blocks and connects to thermostats at terminals L1 & L3.

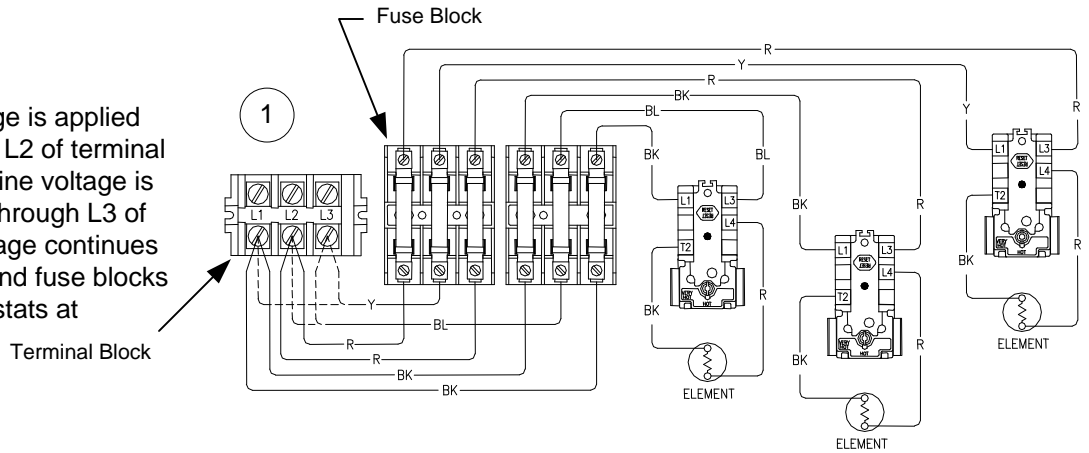

- 2 ECO (high limit) in thermostat is closed, so there is line voltage present at terminal L4 of thermostats and to one side of each element.

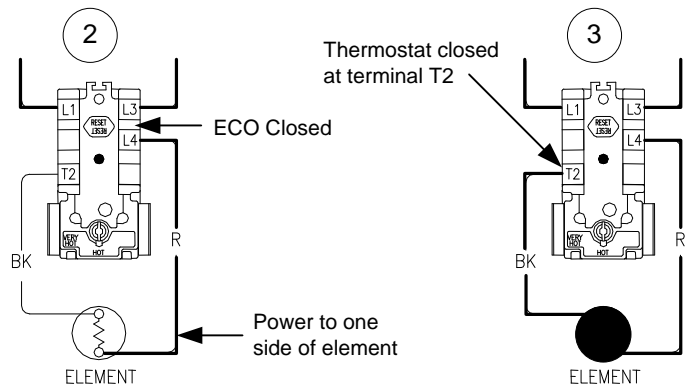

- 3 Water in tank is cold, so all thermostats are closed at terminal T2 (calling For heat). This completes the circuit and allows current to flow through heating element.

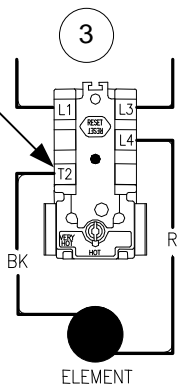

- 4 As each thermostat is satisfied, it opens at terminal T2 interrupting current flow through the respective element. The system is now in stand-by mode, waiting for the next call for heat.

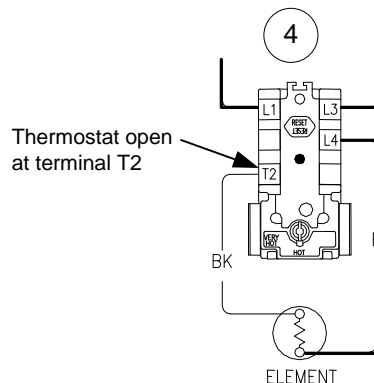

The E32 series medium duty commercial electric water heaters are field convertible. This allows Qualified Service Providers the ability to convert wattage, voltage and phase using a factory supplied conversion kit as required per the installation. Underwriters Laboratories Inc. recognizes this procedure as herein presented and no deviation from these instructions are allowed.

KW Conversion

All E32 series medium duty commercial water heaters are factory wired to the maximum electrical duty for which they have been designed. Therefore, internal electrical components satisfy the maximum voltage and maximum electrical current conditions.

These instructions do not allow for a modification that adds or deletes the number of heating elements originally supplied with the heater; therefore such a modification must not be attempted.

Special factory prepared "Conversion Kits" must be used for these conversions. These kits contain the heating elements, element gaskets and product labeling overlays related to the newly created electrical parameters.

18 KW heaters suitable for operation with 208vac cannot be created by conversion since there are no "kits" established for this electrical system. These heaters can be obtained by ordering directly from the factory.

**Conversion Kit Available
Required**

Total Heater KW	Element Wattage	----- Kit Part Numbers -----		
		208 volts	240 volts	480 volts
6	2000	265-43942-13	265-43942-07	265-43942-01
9	3000	265-43942-14	265-43942-08	265-43942-02
12	4000	265-43942-15	265-43942-09	265-43942-03
13.5	4500	265-43942-16	265-43942-10	265-43942-04
15	5000	265-43942-17	265-43942-11	265-43942-05
18	6000	265-43942-18*	265-43942-12	265-43942-06

*265-43942-18 will require control box replacement (included in kit).

Following the heating element removal and replacement instruction on page 16, remove elements and replace with elements from appropriate kit listed above.

The heaters rating plate will need to be modified because the conversion altered the electrical characteristics of the heater. This rating plate is placed on every Commercial Electric water heater produced by Bradford White Corporation. Element kits above contain rating plate label overlays related to the newly created electrical parameters. Follow the instruction on page 8 For placement of overlays.

Voltage Conversion

1. Voltage conversion is accomplished by replacing the existing elements with elements that are rated at the required voltage.
2. To accomplish this conversion refer to the above procedure for KW Conversion ---- Element Changes.

Control Box Conversion

1. Open front panel of control box installed on water heater and disconnect the (6) load wires from fuse blocks.
2. Remove (4) screws joining control box to water heater and remove control box.
3. Install new control box onto the water heater by feeding the wires through the back of the control box and reinstall (4) mounting screws.
4. Reconnect wires to new fuse blocks. Be certain to match wire colors to Line side of fuse blocks.

NOTICE
Control box conversion is **ONLY** required when converting water heater to 18kw 208v (Kit# 265-43942-18)

 **CAUTION**
Use caution to not damage any of the wire insulation when removing control box.

Electrical Phase Conversion

Electrical phase conversion will require a change from single-phase to three-phase or an opposite conversion change from three-phase to single-phase. Each of these conversions will be explained separately as follows:

Three-Phase to Single-Phase

1. Disconnect blue and yellow wires from terminal L-3 of the terminal block
2. Connect yellow wire to terminal L-1 of the terminal block. The black wires should remain connected to L-1 of the terminal block as it was originally manufactured.
3. Connect blue wire to terminal L-2 of the terminal block. The red wires should remain connected to L-2 of the terminal block as it was originally manufactured.
4. Field wiring for the heater power supply will eventually be connected to terminals L-1 and L-2 of the terminal block when the product is installed.

Single-Phase to Three-Phase

1. Disconnect yellow wire from terminal L-1 of the terminal block
2. Disconnect blue wire from terminal L-2 of the terminal block
3. Connect blue and yellow wires to L-3 of the terminal block
4. Field wiring for the heater power supply will eventually be connected to terminals L-1, L-2, and L-3 of the terminal block when the product is installed.

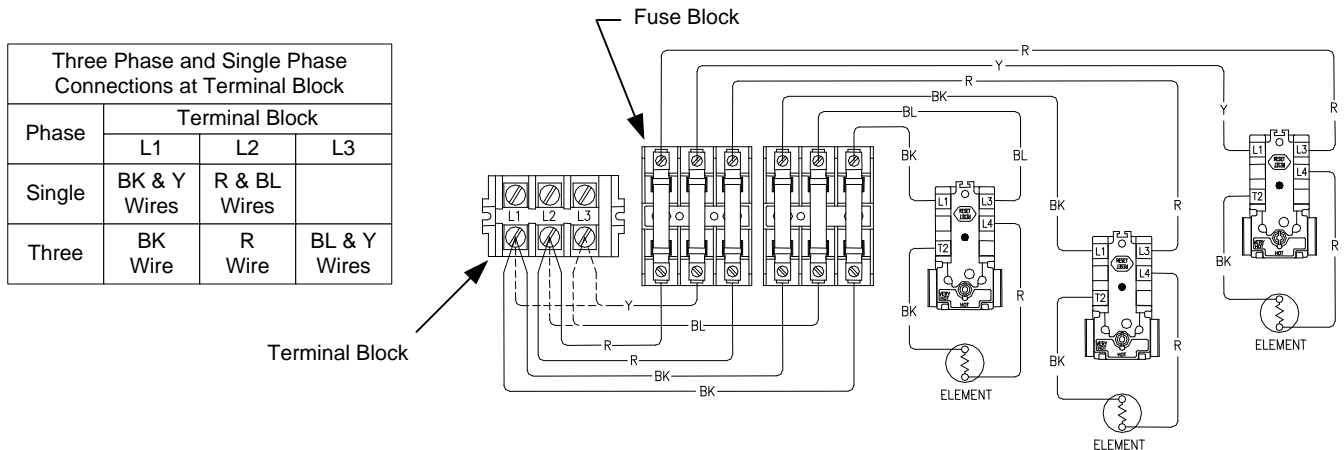

E32 Series Phase Conversion Rating Plate Overlay Kits

6KW	
Volt	Conversion Kit
208	265-45246-13
240	265-45246-07
480	265-45246-01

9KW	
Volt	Conversion Kit
208	265-45246-14
240	265-45246-08
480	265-45246-02

12KW	
Volt	Conversion Kit
208	265-45246-15
240	265-45246-09
480	265-45246-03

13.5KW	
Volt	Conversion Kit
208	265-45246-16
240	265-45246-10
480	265-45246-04

15KW	
Volt	Conversion Kit
208	265-45246-17
240	265-45246-11
480	265-45246-05

18KW	
Volt	Conversion Kit
208	265-45246-18
240	265-45246-12
480	265-45246-06

The heaters rating plate will need to be modified because the conversion altered the electrical characteristics of the heater. This rating plate is placed on every Commercial Electric water heater produced by Bradford White Corporation. Phase conversion kits above contain rating plate overlays related to the newly created electrical parameters. Follow the instruction on page 8 For placement of overlays.

Rating Plate Modification

The heaters rating plate will need to be modified because the conversion altered the electrical characteristics of the heater. Refer to the illustration below that displays a typical commercial electric rating plate that is to be altered. This rating plate is placed on every Commercial Electric water heater produced by Bradford White Corporation. Locate this rating plate on the heater you have just converted.

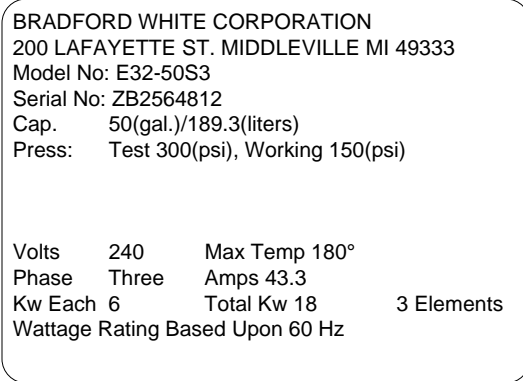

Locate the adhesive backed label (marked as part # 238-43990-00) (see illustration below) that was provided inside the kit. It is marked with the new electrical data that is accurate for the conversion just executed. The kit will contain two labels for this voltage and KW. One for three phase and one for single phase. Select the correct label for the electrical phase in this conversion.

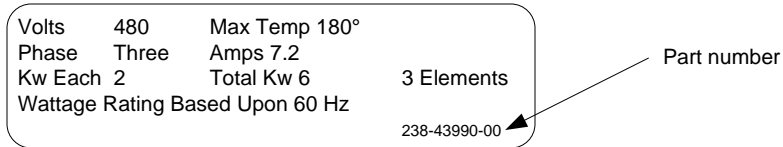

Remove the adhesive peel strip and place this label onto the rating plate in such a manner that the new electrical data will appear in place of the data originally marked. Refer to the illustration below that displays the rating plate revision.

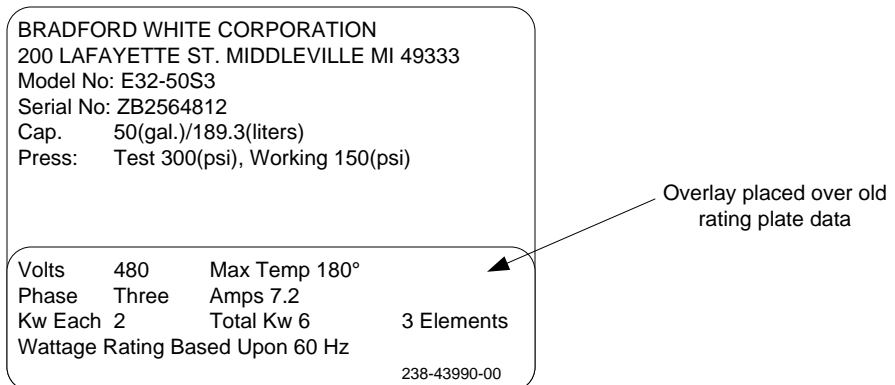

Most common cause for improper electric water heater operation can be linked to heating element failure.

When troubleshooting an electric water heater with the incidence of “No Hot Water” or “Insufficient Amount of Hot Water” It is always a good idea to check the heating elements first following the procedure on page 11.

Common Heating Element Failures Are:

1. **Dry Firing.** Element may be partially submerged in water or most likely, completely exposed with no water in tank. In some cases sediment or lime build up around an element can eventually cause an air pocket, and within seconds, result in a dry fired element. At this point the element becomes inoperative. When element replacement is required, be sure tank is full of water prior to energizing the water heater.
2. **Grounded Element.** An element with a short circuit to ground will in most cases cause the circuit breaker in the service panel to open or shut off. In some cases there may not be enough current draw for the circuit breaker to open. This will allow the heating element to be in continuous operation resulting in over heated water, limited only by the ECO or Energy Cut Off located in the thermostat. Repeated actuation of the ECO reset button on the thermostat usually is the result of a grounded element.
3. **Sediment build up.** Slow hot water recovery can usually be traced back to sediment or lime build up around heating element. Sediment build up can also over time cause a dry fired element.

The illustration below shows a common “Screw-In” type heating element identifying certain features commonly referred to throughout this manual.

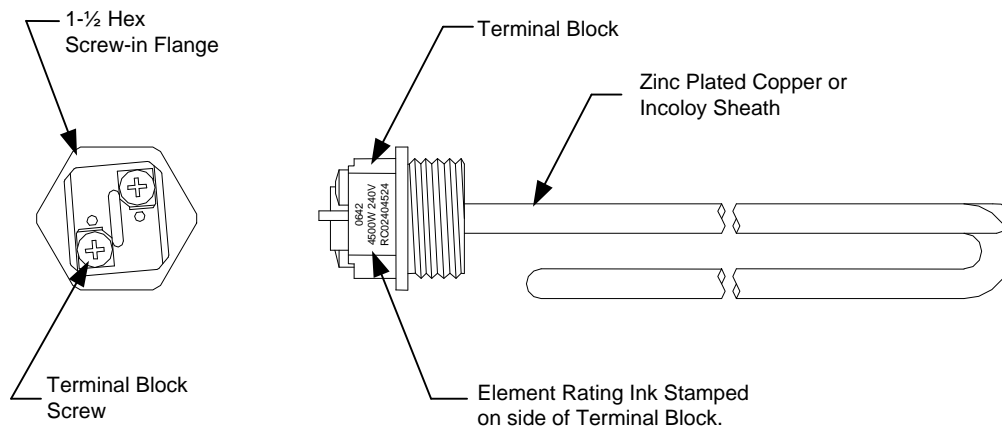

**Typical Direct Immersion “Screw-In”
Type Heating Element**

Quick Step Plan to Hot Water

1. TURN OFF power to water heater and check all wire connections to insure they are tight and corrosion free.
2. Turn power "ON" and determine that line voltage is present (see pg 12), and the high limit (ECO) has not actuated (see pg 13).
3. Check for blown fuse (see pg 13).
4. Check for inoperative heating element (see procedure on page 11).
5. Check for proper thermostat operation (see pg 14). NOTE: Thermostat testing procedures assume items 2, 3 and 4 above are in working order.

⚠ WARNING
High voltage exposure. Use caution when making voltage checks to avoid personal injury.

<u>SYMPTOM</u>	<u>PROBABLE CAUSE</u>	<u>CORRECTIVE ACTION</u>	<u>SERVICE PROCEDURE</u>
No Hot Water	<ol style="list-style-type: none"> 1. No Power to heater. 2. Blown water heater fuses. 3. Loose wire connections. 4. Inoperative heating elements. 5. Inoperative thermostat. 6. Open ECO. 	<ol style="list-style-type: none"> 1. Check fuses or circuit breakers at service panel. 2. Check water heater fuses. 3. Check all wire connections. 4. Check heating element(s). Replace as needed. 5. Check thermostat(s) operation. Replace as needed. 6. Check ECO. Reset or replace thermostat(s) as needed. 	<ol style="list-style-type: none"> 2. See Service Procedure E32-III, Page 13 4. See Service Procedure E32-I, Page 11. 5. See Service Procedure E32-IV, Page 14. 6. See Service Procedure E32-III, Page 13
Not Enough Hot Water	<ol style="list-style-type: none"> 1. Inoperative heating element. 2. Thermostat(s) set to low. 3. Inoperative thermostat(s). 4. Loose wire connection. 5. Sediment or lime build up on element(s). 6. High demand period. 7. Undersized heater. 8. Very cold inlet water to heater. 9. Plumbing connections reversed. 10. Damaged dip tube. 	<ol style="list-style-type: none"> 1. Check heating element(s), replace as needed. 2. Increase thermostat setting. 3. Check thermostat(s), replace as needed. 4. Check all wire connection. 5. Remove heating element(s) and check for lime build up. 6. Reduce demand. 7. Replace with larger heater. 8. Temper water to heater. 9. Correct plumbing connections. 10. Check dip tube, replace as needed. 	<ol style="list-style-type: none"> 1. See Service Procedure E32-I, Page 11. 3. See Service Procedure E32-IV, Page 14. 5. See Service Procedure E32-VI, Page 16. 10. See Service Procedure E32-VII, Page 17.
Slow Hot Water Recovery	<ol style="list-style-type: none"> 1. Sediment or lime build up on element(s). 2. Loose wire connections. 3. Inoperative thermostat(s). 4. Derated heating element installed. 	<ol style="list-style-type: none"> 1. Remove heating element(s) and check for lime build up. 2. Check all wire connections. 3. Check thermostat(s), replace as needed. 4. Check terminal block of element for proper voltage and wattage rating. 	<ol style="list-style-type: none"> 1. See Service Procedure E32-VI, Page 16. 3. See Service Procedure E32-IV, Page 14.
Over Heated Water or Continues Operation	<ol style="list-style-type: none"> 1. Thermostat(s) not in contact with tank. 2. Grounded heating element(s). 3. Thermostat set to high. 4. Inoperative thermostat(s). 5. Inoperative ECO. 6. Undersized water heater. 	<ol style="list-style-type: none"> 1. Position thermostat flush with tank surface. 2. Check heating element(s). Replace as needed. 3. Adjust thermostat(s) to desired setting. 4. Check thermostat(s), replace as needed. 5. Check ECO, replace thermostat as needed. 6. Replace with larger heater. 	<ol style="list-style-type: none"> 1. See Service Procedure E32-V, Page 15. 2. See Service Procedure E32-I, Page 11. 4. See Service Procedure E32-IV, Page 14. 5. See Service Procedure E32-III, Page 13.
Noisy (singing or hissing) Elements	<ol style="list-style-type: none"> 1. Lime formation on elements. 	<ol style="list-style-type: none"> 1. Remove and clean heating elements. Replace as needed. 	<ol style="list-style-type: none"> 1. See Service Procedure E32-VI, Page 16.

Testing For Open Or Burned Out Element.

- Step 1. **TURN OFF POWER TO WATER HEATER.**
- Step 2. Remove thermostat/element access cover(s) from front of water heater. Remove insulation and plastic cover from thermostat.
- Step 3. Disconnect wires from heating element.
- Step 4. Set multi-meter to "ohms" setting.
- Step 5. Touch probes of multi-meter to screw terminals of heating element (see illustration 1).
- Step 6. Reading should be 12.8 ohms (±6%) for a 240 volt, 4500 watt element, see table below:

$$\text{Ohms} = \frac{\text{Volts}^2}{\text{Watts}}$$

A reading outside the range using the formula above (±6%), indicates a bad element and the element must be replaced.

Ohms of electrical Resistance

Element Wattage	Voltage Rating of Element		
	208	240	480
2000	21.6	28.8	115.2
3000	14.4	19.2	76.8
4000	10.8	14.4	57.6
4500	9.6	12.8	51.2
5000	8.7	11.5	46.1
6000	7.2	9.6	38.4

⚠ WARNING
High voltage exposure. Be sure power is turned OFF to water heater prior to performing this procedure.

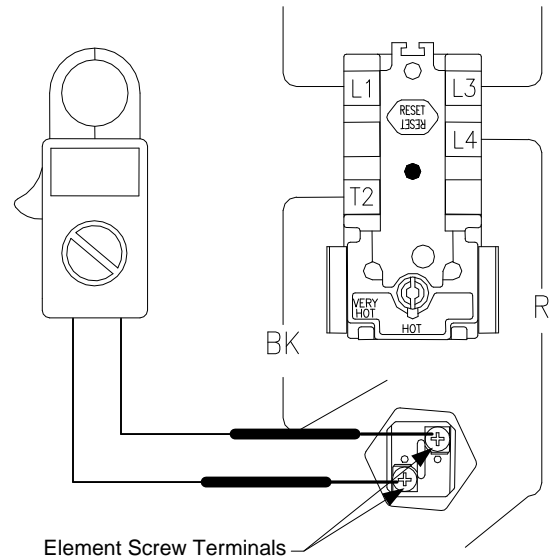

Illustration 1

NOTE
Disconnect element Wires

Testing For Heating Element Short Circuit To Ground.

- Step 1. **TURN OFF POWER TO WATER HEATER.**
- Step 2. Remove access cover(s) from front of water heater. Remove insulation and plastic cover from thermostat.
- Step 3. Disconnect wires from heating element.
- Step 4. Set multi-meter to "ohms" setting.
- Step 5. Touch one probe of multi-meter to either screw terminal of heating element and the other on the element flange (see illustration 2). There should be no reading on the ohm meter. Any reading indicates a grounded element and the element must be replaced. Repeat this step for the other screw terminal.

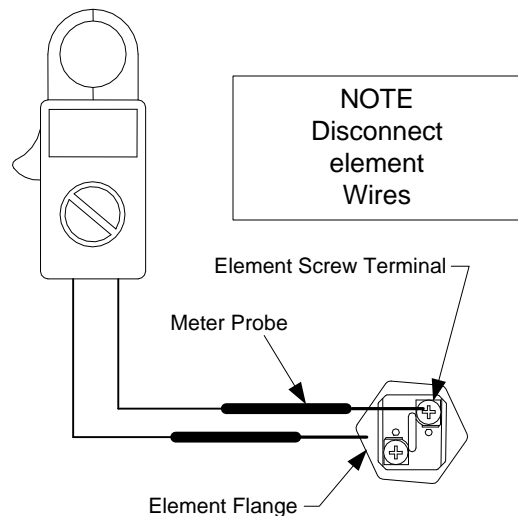

Illustration 2

Line Voltage Testing

⚠ WARNING
High voltage exposure. Use caution when making voltage checks to avoid personal injury.

1. Turn "OFF" power to water heater.
2. Open control box located at the top of the heater to allow access to terminal block.
3. Set multi-meter to volts AC.
4. Turn power "ON" to water heater.
5. For 3 phase service, go to step 7.
6. For single phase service, check voltage across terminals L1 & L2 of terminal block (see illustration 3).

- A) Rated voltage IS present, power to the water heater is okay.
- B) Rated voltage NOT present, Check circuit breaker at service panel.

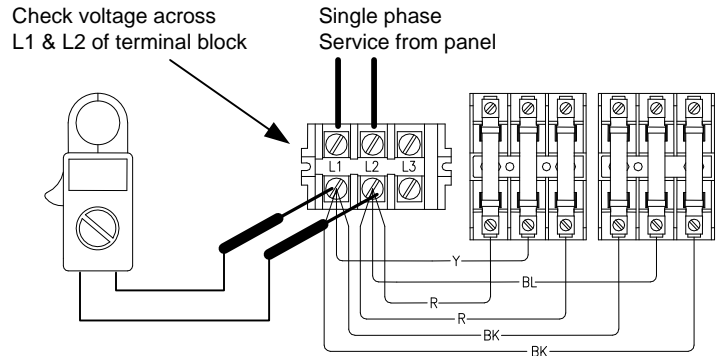

7. For 3 phase service check across L1 & L2 and across L1 and L3 (see illustrations 4 & 5)

- A) Rated voltage IS present, power to the water heater is okay.
- B) Rated voltage NOT present, Check circuit breaker at service panel.

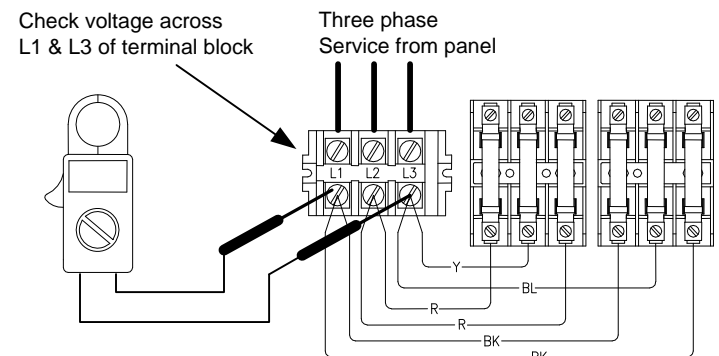
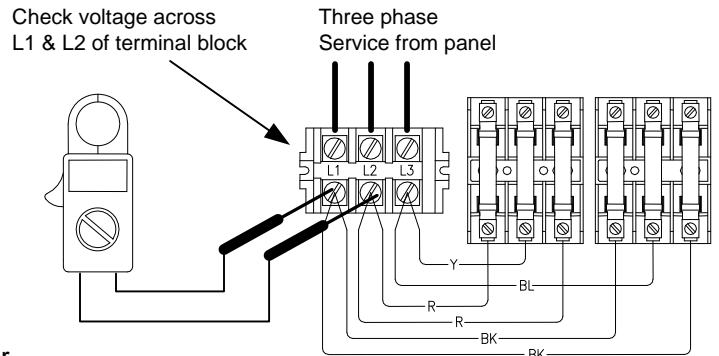

Fuse Testing

1. Turn "OFF" power to water heater.
2. Open control box located at the top of the heater to allow access to fuse block.
3. Disconnect wire leads from fuse block. NOTE: It may be necessary to label wires for proper re-connection when finished.
4. Set multi-meter to the "Ohms" setting.
5. Check continuity across upper and lower screw terminal of fuse block for each individual fuse, six total (see illustration 6).

- A) Continuity IS present, fuse is okay.
- B) Continuity NOT present, Replace with new fuse Class "G", 480 Volt MAX, 30 Amp.

⚠ WARNING
High voltage exposure. Be sure power is turned OFF to water heater prior to performing this procedure.

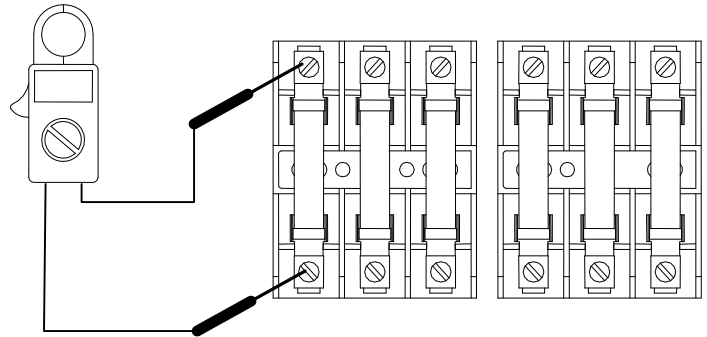

Illustration 6

ECO (high limit) testing

1. This procedure assumes line voltage and fuses are in working order.
2. Turn power "OFF" to water heater.
3. Remove thermostat/element access cover(s) located near the bottom of the water heater.
4. Remove insulation and plastic cover from thermostat.
5. Turn power "ON" to water heater.
6. Check voltage across terminals L1 & L4 for all thermostats (see illustration 7).

- A) Rated Voltage IS present, ECO is okay.
- B) Rated voltage NOT present, proceed to step 7.

7. Turn power "OFF" to water heater and firmly press ECO reset button on thermostat(s). Turn power "ON" to water heater and recheck voltage across terminals L1 & L4 of thermostat(s).

- A) Rated voltage IS present, the ECO has previously opened indicating the water in the tank, at some point did overheat, Check the following:
 1. Thermostat must be in full contact with tank.
 2. Be sure heating element(s) is not shorted to ground (see page 11).
 3. Proper thermostat operation (see procedures on page 14).

- B) Rated voltage NOT present, water in tank may be over heated.
 1. If water is hot, turn "OFF" power to water heater and flow water through tank to cool below set point of upper thermostat. Recheck voltage per step 6.
 2. If water is cool, Replace thermostat(s).

⚠ WARNING
High voltage exposure. Use caution to avoid personal injury during this procedure.

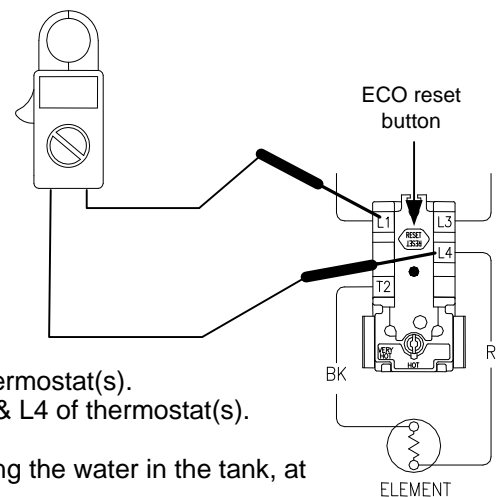

Illustration 7

Thermostat Operation Testing

⚠ WARNING
High voltage exposure. Use caution to avoid personal injury during this procedure.

Water In Tank Is Cold With Power ON.

1. This procedure assumes line voltage, ECO and elements are in working order.
2. Turn power "ON" to water heater.
3. Set multi-meter to "Volts AC".
4. Check across terminals L1 & L3 of thermostat (see illustration 8)
 - A) Rated voltage NOT present, Check fuses.
 - B) Rated voltage IS present, proceed to next step.
5. Check across terminals L4 and T2 of thermostat (see illustration 9)
 - A) Rated voltage NOT present, Recheck ECO. If ECO is okay, replace thermostat.
 - B) Rated voltage IS present, okay thermostat is calling for heat, proceed to next step.

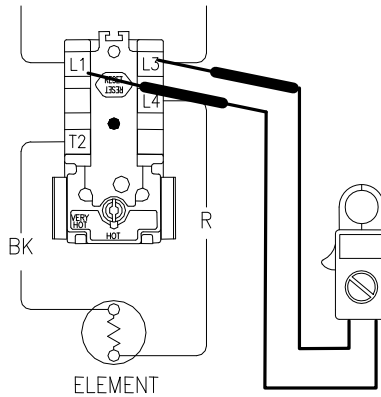

Illustration 8

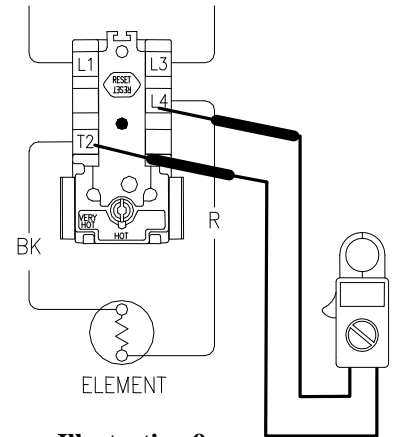

Illustration 9

6. Check across element terminals (see illustration 10)
 - A) Rated voltage NOT present, check wire connections from thermostat to element.
 - B) Rated voltage IS present, Repeat element testing see page 11.

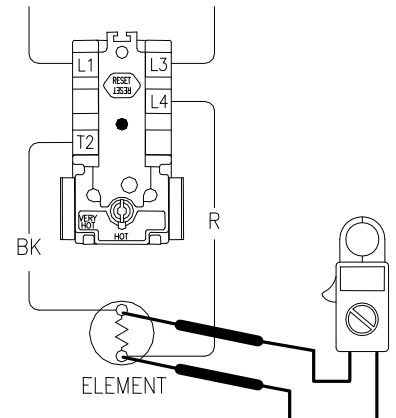

Illustration 10

Water Temperature In Tank Is Above Thermostat Setting.

1. This procedure assumes line voltage, ECO and elements are in working order.
2. Turn power "ON" to water heater.
3. Set multi-meter to "Volts AC".
4. See illustration 9 above, check across terminals L4 and T2 of thermostat.
 - A) Rated voltage IS present, replace thermostat.
 - B) Rated voltage NOT present, thermostat is okay.
 - C) Lower than rated voltage IS present, recheck for grounded element (see page 11).

Thermostat Removal

1. Turn power "OFF" To water heater.
2. Remove access cover(s) and insulation.
3. Remove plastic thermostat protector from thermostat(s).
4. Disconnect wires from thermostat terminals. It may be necessary to label wires for proper re-connection to new thermostat.
5. Note thermostat temperature setting for proper setting of new thermostat.
6. Slide thermostat upwards and out of mounting bracket.



WARNING

High voltage exposure. Be sure power is "OFF" when performing this procedure.

Thermostat Replacement

1. Use a stiff brush to remove any debris or loose scale from tank surface where new thermostat will be installed.
2. Slide new thermostat down into thermostat bracket until it snaps into place. **IMPORTANT!** Thermostat must set completely flat or flush to tank surface. An improperly installed thermostat will cause improper water heater operation.
3. Refer to the wire diagram located on the inside of the control box cover and re-connect wires to the thermostat. Be sure wire connections are snug and corrosion free. Do not over tighten, doing so may damage thermostat.
4. Set thermostat to the original thermostat setting found on the old thermostat.
5. Re-install plastic thermostat protector.
6. Re-install insulation and access cover.
7. Restore power to water heater and verify proper heater operation.

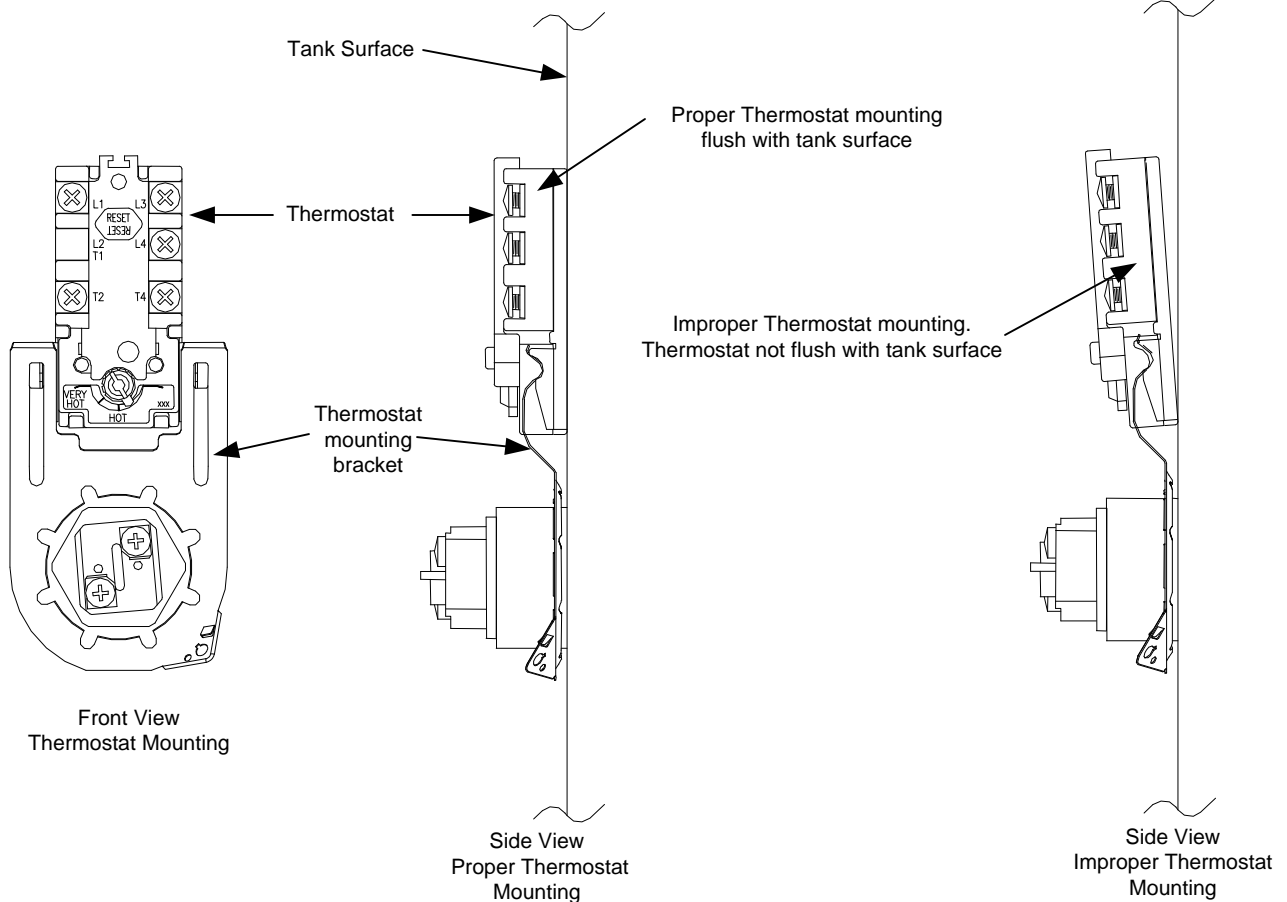

Heating Element Removal

1. Turn power "OFF" To water heater.
2. Turn off cold water supply to heater. Connect hose to drain spigot of water heater and route to an open drain. Open a nearby hot water faucet to vent heater for draining. Open drain spigot of water heater and allow heater to drain to a point below the Element(s).
3. Close drain spigot and remove hose.
3. Remove access cover(s) and insulation.
4. Remove plastic thermostat protector from thermostat(s).
5. Disconnect wires from element terminals.
6. Remove element from tank using 1-½ deep well socket or appropriate wrench. Unscrew element counter-clockwise to remove from tank.
7. Be sure to remove old element gasket from the tank. It is not recommended to be re-used.

⚠ WARNING
High voltage exposure. Be sure power is **"OFF"** when performing this procedure.

⚠ WARNING
Heater components and stored water may be **HOT** when performing the following steps in this procedure. Take necessary precaution to prevent personal injury.

Heating Element Replacement

1. Check element terminal block for proper electrical rating. NOTE: Some elements have dual ratings, be sure to check all surfaces of the element terminal block (see illustration below).
2. Apply new element gasket to the new element. Be sure gasket is seated flat against element flange without rolls or gaps (see illustration below).
3. Clean any debris from element fitting on tank. Lubricate element threads as needed with thread lubricant.
4. Thread new element clockwise into tank. Tighten element using 1-½ deep well socket or appropriate wrench. Do not over tighten, over tightening may damage element gasket.
5. Reconnect wires to element, be sure connections are snug and corrosion free. Do not over tighten, doing so may damage terminal block.
6. Resume water supply to heater, be sure tank is full of water and check for leaks.
7. Re-install plastic thermostat protector(s).
8. Re-install insulation and access cover(s).
9. To resume operation, **BE SURE TANK IS FULL OF WATER** and restore power to water heater. Verify proper heater operation.

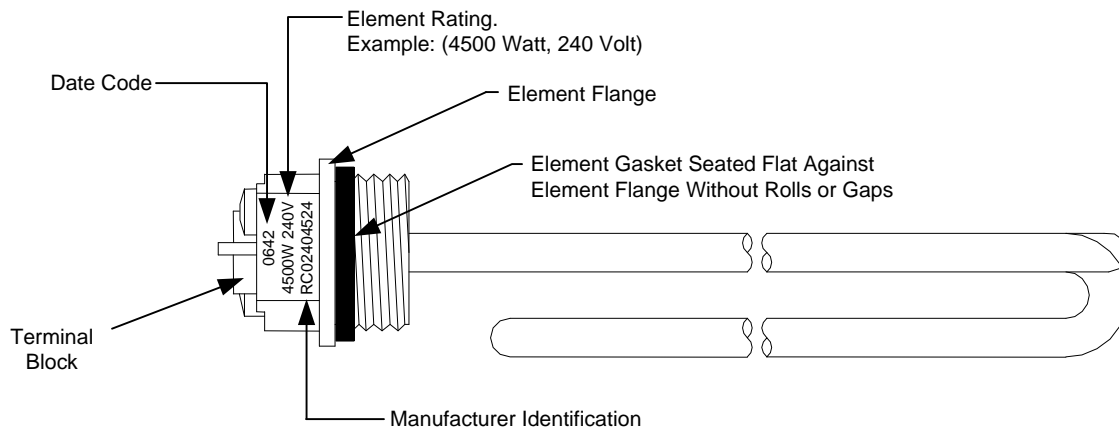

Dip Tube Inspection and Replacement

WARNING

Heater components and stored water may be HOT when performing the following steps in this procedure. Take necessary precaution to prevent personal injury.

- Step 1. Turn power "OFF" to water heater.
- Step 2. Turn off cold water supply to heater. Connect hose to drain spigot of water heater and route to an open drain. Open a nearby hot water faucet to vent heater for draining. Open drain spigot of water heater and allow heater to drain to a point below the inlet connection nipple.
- Step 3. Close drain spigot and remove hose.
- Step 4. Disconnect inlet nipple from plumbing system.
- Step 5. With an appropriate wrench, remove inlet nipple/dip tube from the water heater. Use caution not to damage nipple threads.
- Step 6. Visually inspect inlet nipple/dip tube. Inlet nipple/dip tube should be free of cracks and any blockage. Hydro-jets located near the bottom of the dip tube should be open and free of any blockage. Anti-siphon hole located approximately 6" from the bottom of nipple, should be free of any blockage.

Any damage such as cracks, restriction due to deformation or unintentional holes are not field repairable and the inlet nipple/dip tube must be replaced.
- Step 7. Upon completion of inspection or subsequent replacement, reinstall inlet nipple/dip tube into heater. Connect nipple to plumbing system, close spigot and remove drain hose, resume water supply and refill heater with water.
- Step 8. To resume operation, **BE SURE TANK IS FULL OF WATER** and turn power "ON" to water heater.

Anode Inspection and Replacement

- Step 1. Turn power "OFF" to water heater.
- Step 2. Turn off cold water supply to heater. Connect hose to drain spigot of water heater and route to an open drain. Open a nearby hot water faucet to vent heater for draining. Open drain spigot of water heater and allow heater to drain to a point below the outlet connection nipple.
- Step 3. Close drain spigot and remove hose.
- Step 4. Disconnect outlet nipple from plumbing system.
- Step 5. With an appropriate wrench, remove outlet nipple/anode from the water heater. Use caution not to damage nipple threads.
- Step 6. Visually inspect outlet nipple/anode. Outlet nipple/anode should show signs of depletion, this is normal. If depletion is $\frac{1}{2}$ of the original anode diameter (original diameter approximately $\frac{3}{4}$ "), replacement is recommended. If any of the steel core of the anode is exposed, replacement is recommended.
- Step 7. Upon completion of inspection or subsequent replacement, reinstall outlet nipple/anode into heater. Connect nipple to plumbing system, close spigot and remove drain hose, resume water supply and refill heater with water.
- Step 8. To resume operation, **BE SURE HEATER IS FULL OF WATER** and turn power "ON" to water heater.

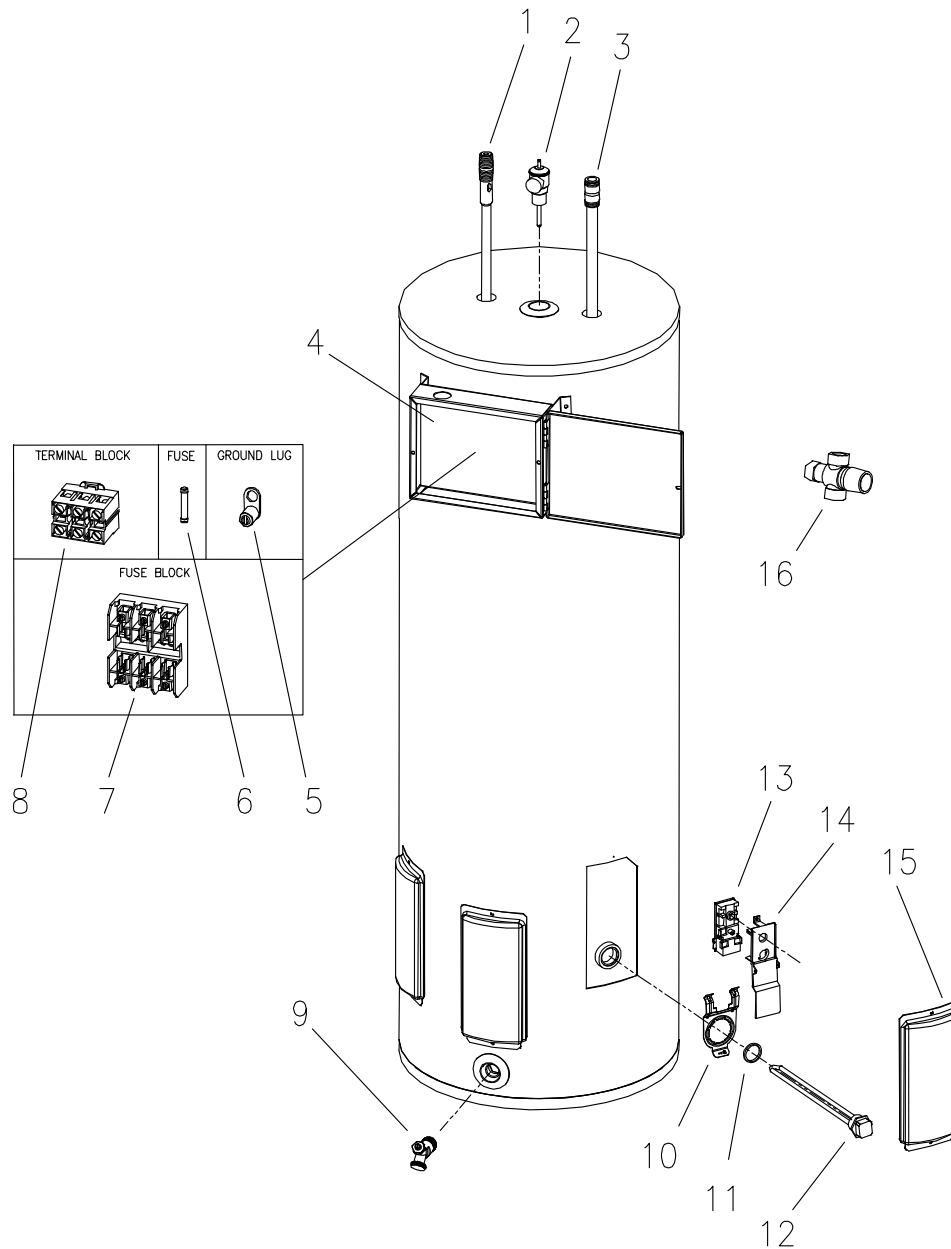

- | | |
|------------------------------|---|
| 1. Hot Water Outlet Anode | 8. Terminal Block |
| 2. T&P Relief Valve | 9. Brass Drain Valve |
| 3. Cold Water Inlet Dip Tube | 10. Thermostat Mounting Bracket |
| 4. Control Box | 11. Element Gasket |
| 5. Ground Lug | 12. Heating Element |
| 6. Fuse | 13. Thermostat Surface Mount |
| 7. Fuse Block | 14. Thermostat Protector |
| | 15. Thermostat/Element Access Cover |
| | 16. ASSE Approved Mixing Valve (optional) |



Ambler, PA

For U.S. and Canada field service,
contact your professional installer or
local Bradford White sales representative.

Sales/800-523-2931
Fax/215-641-1670
Parts Fax/215-641-2180

Technical Support/800-334-3393
Fax/269-795-1089

Warranty/800-531-2111
Fax/269-795-1089

International:
Telephone/215-641-9400
Telefax/215-641-9750



Mississauga, ON

Sales/866-690-0961
905-238-0100

Fax/905-238-0105

Technical Support/800-334-3393

Email

parts@bradfordwhite.com
techserv@bradfordwhite.com

www.bradfordwhite.com