

GAS-FIRED WATER HEATER

A Spanish language version of these instructions is available by contacting the company listed on the rating plate.

La version espanola de estas instrucciones se puede obtener al escribirle a la fabrica cuyo nombre aparece en la placa de especificaciones.

INSTALLATION & OPERATING INSTRUCTION MANUAL For Flammable Vapor Ignition Resistant System Equipped Water Heater

WARNING: If the information in these instructions is not followed exactly, a fire or explosion may result causing property damage, personal injury or death.

FOR YOUR SAFETY

–Do not store or use gasoline or other flammable, combustible, or corrosive vapors and liquids in the vicinity of this or any other appliance.

– WHAT TO DO IF YOU SMELL GAS

- Do not try to light any appliance.
- Do not touch any electrical switch; do not use any phone in your building.
- Immediately call your gas supplier from a neighbor's phone. Follow the gas supplier's instructions.
- If you cannot reach your gas supplier, call the fire department.

– Installation and service must be performed by a qualified installer, service agency or the gas supplier.

For your family's comfort, safety and convenience, we recommend this water heater be installed and serviced by a plumbing professional.



CONGRATULATIONS!

You have just purchased one of the finest water heaters on the market today!

This installation, operation and instruction manual will explain in detail the installation and maintenance of your new Flammable Vapor Ignition Resistant Gas Water Heater. We strongly recommend that you contact a plumbing professional for the installation of this water heater.

We require that you carefully read this manual, as well as the enclosed warranty, and refer to it when questions arise. If you have any specific questions concerning your warranty, please consult the plumbing professional from whom your water heater was purchased. For your records we recommend that you write the model, serial number and installation date of your water heater in the maintenance section in the back of this manual.

This manual should be kept with the water heater.

Special Flammable Vapor Ignition Resistant System:

This water heater is equipped with a Flammable Vapor Ignition Resistant System. In the event of improper usage or storage of gasoline or other flammable materials in the location where the water heater is installed, the technology will resist ignition of the flammable vapors outside the confines of the water heater.

The Flammable Vapor Ignition Resistant System features:

- Advanced Flame Arrestor Design.
- Re-settable Thermal Switch to prevent burner/pilot operation with restricted airflow.
- Piezo Igniter
- Sight Window to observe operation of pilot and burner.

FOR YOUR SAFETY: Activation of the Flammable Vapor Ignition Resistant System occurs when flammable vapors are drawn into the water heater and are combusted. If flammable vapors are detected:

- Do not try to light any appliance.
- Do not touch any electrical switch; Do not use any phone in your building.
- Leave the premises and immediately call the fire department from a neighbor's phone. Follow the fire department's instructions.

Once the flammable vapor has been evacuated, contact your plumbing professional or the manufacturer for further instructions. Replacement of a Flammable Vapor Ignition Resistant System equipped water heater due to a flammable vapor shutdown is not covered under the terms of the limited warranty.



TABLE OF CONTENTS

GENERAL INFORMATION	page 4
INSTALLATION	6
Locating The Water Heater	6
Minimum Clearances	9
Venting	10
Combustion Air Supply	11
Water Connections	13
Gas Connections	16
GENERAL OPERATION	17
Lighting and Shutdown Instructions	18
Thermostat Adjustment	20
Burner Flame Check	22
MAINTENANCE	23
TROUBLESHOOTING	26
INSTALLATION DRAWING FOR POTABLE WATER	28
PARTS LIST DRAWING	29
PARTS LIST	30
INSTALLATION INSTRUCTIONS FOR POTABLE WATER AND SPACE HEATING	31
NOTES	32

GENERAL INFORMATION

This gas-fired water heater is design certified by CSA International under the applicable American National Standard, Z21.10.1 or CSA 4.1-(as indicated on the rating plate), available from CSA International, 8501 East Pleasant Valley Road, Cleveland, OH U.S.A. 44131-5575.

This water heater must be installed in accordance with local codes. In the absence of local codes, it must be installed in compliance with the National Fuel Gas Code (ANSI Z223.1-Latest Edition), or in Canada CAN/CGA B149.1 Natural Gas Installation Code (Latest Edition) or CAN/CGA B149.2 Propane Installation Code (Latest Edition). The warranty for this water heater is in effect only when the water heater is installed, adjusted, and operated in accordance with these Installation and Operating Instructions. The manufacturer will not be liable for any damage resulting from alteration and/or failure to comply with these instructions.

This water heater is not design certified for installation in a mobile home. Such an installation may create a hazardous condition and will nullify the warranty.

This water heater has been designed and certified for the purpose of heating potable water. The installation and use of this water heater for any purpose other than the heating of potable water may cause damage to the water heater, create a hazardous condition, and nullify the warranty.

CAUTION

Incorrect operation of this appliance may create a hazard to life and property and will nullify the warranty.

Do not use this appliance if any part has been submerged in water. Immediately call a qualified service technician to inspect the appliance and to replace any part of the control system and any gas control, which has been under water. Depending upon the individual circumstances, it may be necessary to replace the entire water heater.

DANGER

Do not store or use gasoline or other flammable, combustible, or corrosive vapors and liquids in the vicinity of this or any other appliance.

IMPORTANT

Before proceeding, please inspect the water heater and components for possible damage. **DO NOT** install any damaged components. If damage is evident then please contact the supplier where the water heater was purchased or the manufacturer listed on the rating plate for replacement parts.

This water heater has been manufactured for operation at altitudes from sea level to 2000 feet (610m) (unless otherwise specified on the water heater rating plate). For use of this appliance at an elevation greater than 2000 feet (610m), contact the dealer or manufacturer listed on the rating plate for information on any necessary modification. Uncorrected operation of this appliance may create a hazard to life and property.

Make sure that you check the rating plate and combination gas control on the water heater to be certain that the type of gas being supplied corresponds with the marking on the rating plate and combination gas control.

A sacrificial anode is used to extend tank life. The removal of this anode, for any reason, will nullify the warranty. In areas where water is unusually active, an odor may occur at the hot water faucet due to a reaction between the sacrificial anode and the impurities in the water. If this should happen, an alternative anode may be purchased from the supplier that installed this water heater. This will minimize the odor while protecting the tank. Additionally, the water heater should be flushed with appropriate dissolvers to eliminate any bacteria.

INSTALLATION

LOCATING THE WATER HEATER

WARNING

Water heaters are heat producing appliances. To avoid damage or injury there shall be no materials stored against the water heater or vent-air intake system and proper care shall be taken to avoid unnecessary contact (especially by children) with the water heater and vent-air intake components. **UNDER NO CIRCUMSTANCES SHALL FLAMMABLE MATERIALS, SUCH AS GASOLINE OR PAINT THINNER BE USED OR STORED IN THE VICINITY OF THIS WATER HEATER, VENT-AIR INTAKE SYSTEM OR IN ANY LOCATION FROM WHICH FUMES COULD REACH THE WATER HEATER OR VENT-AIR INTAKE SYSTEM.**

This water heater **MUST NOT** be installed in any location where gasoline or flammable vapors are likely to be present, unless the installation is such to eliminate the probable ignition of gasoline or flammable vapors.

Water heaters in residential garages must be installed and located, or protected, to avoid physical damage. For other installations refer to local codes. In the absence of local codes, the water heater must be installed in compliance with the National Fuel Gas Code, (ANSI Z223.1-Latest Edition), or in Canada CAN/CGA B149.1 Natural Gas Installation Code (Latest Edition) or CAN/CGA B149.2 Propane Installation Code (Latest Edition).

The location of this water heater is of the utmost importance. Before installing this water heater read the Installation section of these instructions. After reading these Installation and Operating Instructions, select a location for the water heater where the floor is level and is easily accessible to gas and water supply lines. **DO NOT locate the water heater where water lines could be subjected to freezing temperatures. Make sure the cold water pipes are not located directly above the gas control so that condensate during humid weather does not drip on the controls.**

This water heater MUST be installed indoors out of the wind and weather.

To comply with NSF requirements this water heater is to be:

- a) Sealed to the floor with sealant, in a smooth and easily cleanable way, or
- b) Installed with an optional leg kit that includes legs and/or extensions that provide a minimum clearance of 6" beneath the water heater.

Installation (Locating The Water Heater) continued-

Note: For California installation this water heater must be braced, anchored, or strapped to avoid falling or moving during an earthquake. See instructions for correct installation procedures. Instructions may be obtained from DSA Headquarters Office, 1102 Q Street, Suite 5100, Sacramento, CA 95811.

Water heater corrosion and component failure can be caused by the heating and breakdown of airborne chemical vapors. Examples of some typical compounds that are potentially corrosive are: spray can propellants, cleaning solvents, refrigerator and air conditioning refrigerants, swimming pool chemicals, calcium and sodium chloride, waxes and process chemicals. These materials are corrosive at very low concentration levels with little or no odor to reveal their presence. **NOTE: DAMAGE TO THE WATER HEATER CAUSED BY EXPOSURE TO CORROSIVE VAPORS IS NOT COVERED BY THE WARRANTY. DO NOT OPERATE THE WATER HEATER IF EXPOSURE HAS OR WILL OCCUR. DO NOT STORE ANY POTENTIALLY CORROSIVE COMPOUNDS IN THE VICINITY OF THE WATER HEATER.**

 WARNING

Liquefied petroleum gases/propane gas are heavier than air and will remain at floor level if there is a leak. Basements, crawl spaces, closets and areas below ground level will serve as pockets for accumulation of leaking gas. Before lighting, smell all around the appliance area for gas. Be sure to smell next to the floor.

IF YOU SMELL GAS:

- Do not try to light any appliance.
- Do not touch any electric switch; do not use any telephone in your building.
- Immediately call your gas supplier from a neighbor's telephone. Follow the gas supplier's instructions.
- If you cannot reach your gas supplier, call the fire department.

DO NOT OPERATE APPLIANCE UNTIL LEAKAGE IS CORRECTED!

▲WARNING

DO NOT ATTEMPT TO LIGHT ANY GAS APPLIANCE IF YOU ARE NOT CERTAIN OF THE FOLLOWING:

- Liquefied petroleum gases/propane gas and natural gas have an odorant added by the gas supplier that aids in detection of the gas.
- Most people recognize this odor as a “sulfur” or “rotten egg” smell.
- Other conditions, such as “odorant fade” can cause the odorant to diminish in intensity, or “fade”, and not be as readily detectable.
- If you have a diminished sense of smell, or are in any way unsure of the presence of gas, immediately contact your gas supplier from a neighbor’s telephone.
- Gas detectors are available. Contact your gas supplier or plumbing professional for more information.

Proper venting practices must be considered when selecting a location for this water heater. For exact venting specifications, please consult the Venting section of these Installation and Operating Instructions.

This water heater must be located in an area where leakage of the tank, water line connections, or the combination temperature and pressure relief valve will not result in damage to the area adjacent to the water heater or to lower floors of the structure. When such locations cannot be avoided, a suitable drain pan must be installed under the water heater. The drain pan must have a minimum length and width of at least 4 in. (10.2 cm) greater than the diameter of the water heater and must not restrict proper combustion air flow to the water heater. The drain pan, as described above, can be purchased from your plumbing professional. The drain pan must be piped to an adequate drain. The piping must be at least 3/4 inch (1.9 cm) in diameter and pitched for proper drainage.

It is recommended that a minimum clearance of four (4) inches (10.2 cm) be provided on the side of the water heater for servicing and maintenance of the combination temperature and pressure relief valve.

MINIMUM CLEARANCES

▲WARNING

Failure to adhere to these installation and operating instructions may create a hazard to life and property and will nullify the warranty.

This installation shall allow access to the front of the water heater and adequate clearance shall be provided for servicing and operating this water heater. The water heater may be installed on either a combustible or non-combustible floor. If the water heater is to be installed directly on carpeting, it shall be installed on top of a metal or wood panel (or equivalent) extending beyond the full width and depth of the appliance by at least three (3) inches (7.6 cm) in any direction or, if the appliance is to be installed in an alcove or closet, the entire floor shall be covered by the panel. **If the rating plate or the label on the front of the heater specifies minimum clearances less than those listed in the below table, the water heater may be installed in accordance with the minimum clearances listed on the rating plate or the label on the front of the heater.**

If it is necessary to install this water heater in an alcove, use the clearances listed in Figure 1.

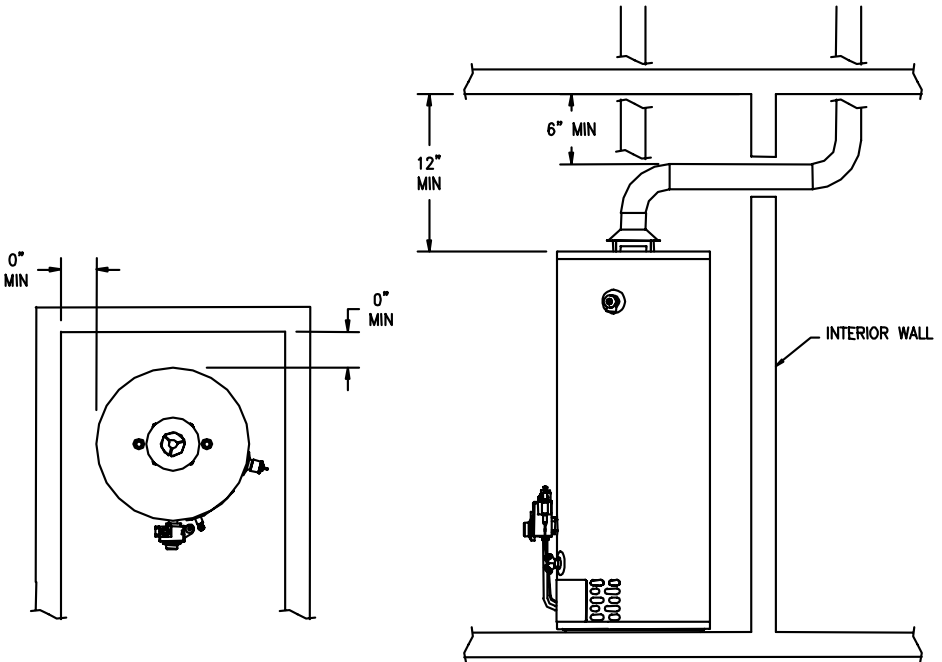

Figure 1

VENTING

WARNING

The venting system must be installed properly following all local codes or in the absence of local codes, the latest edition of the National Fuel Gas Code (ANSI Z223.1- latest edition), or in Canada, The Natural Gas and Propane Installation Code (B149.1-00 latest edition). Failure to properly install the venting system could result in property damage, personal injury, or death.

WARNING

Carefully inspect the venting system of a replacement water heater installation before connecting to the venting system. All joints in the vent connector must be securely fastened with screws and fit tightly together. Inspect the venting system for signs of deterioration (rust and perforation) and replace any sections that are not in good condition.

The chimney must be lined and in good condition. Check to make sure the venting system is properly sized for the water heater. If the venting system was previously sized for another gas appliance that has been removed, the venting system may now be too large. Refer to the latest edition of the National Fuel Gas Code (ANSI Z223.1-latest edition), or in Canada, the Natural Gas and Propane Installation Code (B149.1-00 latest edition) for the correct sizing of venting systems and common venting with another gas appliance.

Do not vent this water heater into the venting system of another gas appliance designed to vent under positive pressure.

The water heater should be installed as close as practical to the venting system to minimize the vent connector length required. Refer to local codes for the distance limitations on vent connector lengths.

At the completion of the water heater installation, the burner and venting system must be checked for proper operation with all other commonly vented appliances in operation. Check for spillage of flue products around the outside relief opening of the draft hood after several minutes of operation. The flame from a match should be drawn into the draft hood. Do not use the water heater or connected equipment if spillage is detected until the problem is corrected. Refer to the latest edition of the National Fuel Gas Code, or in Canada, the Natural Gas and Propane Installation Code for complete details on the "Procedure to Be Followed to Place Equipment in Operation".

This water heater has been shipped with a draft diverter for which it was designed with reference to the horizontal and vertical planes. If removed, the draft diverter must be replaced in the same position and secured to the jacket top by the screws with which it was installed.

Venting continued-

This water heater must be connected to a lined masonry chimney or venting system approved by local codes or ordinances. The vent connector used to attach the draft diverter outlet to the chimney or approved vent must be of the same diameter as the draft diverter outlet or larger. For proper venting in certain installations, a larger vent connector may be needed. Consult venting tables in ANSI standard (Z223.1-or latest edition), National Fuel Gas Code and CAN/CGA (B149.1 or B149.2-latest editions) Natural Gas and Propane Installation Code, or local code officials for proper application for your area.

Combustion Air Supply

▲WARNING

Liquefied petroleum gases/propane gas are heavier than air and will remain at floor level if there is a leak. Basements, crawl spaces, closets and areas below ground level will serve as pockets for accumulation of leaking gas. Before lighting, smell all around the appliance area for gas. Be sure to smell next to the floor.

IF YOU SMELL GAS:

- Do not try to light any appliance.
- Do not touch any electric switch; do not use any telephone in your building.
- Immediately call your gas supplier from a neighbor's telephone. Follow the gas supplier's instructions.
- If you cannot reach your gas supplier, call the fire department.

DO NOT OPERATE APPLIANCE UNTIL LEAKAGE IS CORRECTED!

IMPORTANT

The flow of combustion and ventilating air must not be obstructed.

- Do not block or in any way restrict jacket air inlet slots located at the bottom front of the water heater.

Provide adequate air for combustion and ventilation. An insufficient supply of air will cause recirculation of combustion products resulting in air contamination that may be hazardous to life. Such a condition often will result in a yellow, luminous burner flame, causing carboning or sooting of the combustion chamber, burners and flue tubes with possible damage to the water heater.

When an exhaust fan is installed in the same room with a heater, sufficient openings for air must be provided in the walls. Undersized openings will cause air to be drawn into the room through the chimney, causing recirculation of combustion products.

Combustion Air Supply continued-

Confined Spaces

Confined spaces are spaces defined as having less than 50 ft.³ of space per 1,000 BTU ($1.41m^3/.29kw$) per hour of input.

Unconfined Spaces

In unconfined spaces in buildings, infiltration may be adequate to provide air for combustion, ventilation and dilution of flue gases. However, in buildings of tight construction (for example, weather stripping, heavily insulated, caulked, vapor barrier, etc.), additional air may need to be provided using the methods described above under CONFINED SPACES: All Air From Outdoors or SPECIALLY ENGINEERED INSTALLATIONS.

All Air From Inside the Building: The confined space shall be provided with two permanent openings communicating directly with an additional room(s) of sufficient volume so that the combined volume of all spaces meets the criteria for an unconfined space. The total input of all gas utilization equipment installed in the combined space shall be considered in making this determination. Each opening shall have a minimum free area of 1 square inch per 1000 BTU ($6.45cm^2/.29kw$) per hour of the total input rating of all gas utilization equipment in the confined space, but not less than 100 square inches ($645cm^2$). One opening shall be within 12 inches ($31cm$) of the top and one within 12 inches ($31cm$) of the bottom of the enclosure.

All Air From Outdoors: The confined space shall be provided with two permanent openings, one commencing within 12 inches ($31cm$) of the top and one commencing within 12 inches ($31cm$) from the bottom of the enclosure. The openings shall communicate directly, or by ducts, with the outdoors or spaces (crawl or attic) that freely communicate with the outdoors.

1. When directly communicating with the outdoors, each opening shall have a minimum free area of 1 square inch per 4000 BTU ($6.45cm^2/1.2kw$) per hour of total input rating of all equipment in the enclosure.
2. When communicating with the outdoors through vertical ducts, each opening shall have a minimum free area of 1 square inch per 4000 BTU ($6.45cm^2/1.2kw$) per hour of total input rating of all equipment in the enclosure.
3. When communicating with the outdoors through horizontal ducts, each opening shall have a minimum free area of 1 square inch per 2000 BTU ($6.45cm^2/.6kw$) per hour of total input rating of all equipment in the enclosure.
4. When ducts are used, they shall be of the same cross-sectional area as the free area of the openings to which they connect. The minimum dimension of rectangular air ducts shall be not less than 3 inches ($7.5cm$)

Specially Engineered Installations

The requirements noted under CONFINED SPACES above shall not necessarily govern when special engineering, approved by the authority having jurisdiction, provides an adequate supply of air for combustion, ventilation, and dilution of flue gases.

WATER CONNECTIONS

Note: *BEFORE PROCEEDING WITH THE INSTALLATION, CLOSE THE MAIN WATER SUPPLY VALVE.*

After shutting off the main water supply, open a faucet to relieve the water line pressure to prevent any water from leaking out of the pipes while making the water connections to the water heater. After the pressure has been relieved, close the faucet. The COLD water inlet and HOT water outlet are identified on the top of the water heater. The fittings at the cold water inlet and hot water outlet are dielectric waterway fittings with 3/4" NPT male thread. Make the proper plumbing connections between the water heater and the plumbing system to the house. Install a shut-off valve in the cold water supply line.

CAUTION

If sweat fittings are to be used, **DO NOT** apply heat to the nipples on top of the water heater. Sweat the tubing to the adapter before fitting the adapter to the water connections. It is imperative that heat is not applied to the nipples containing a plastic liner.

WARNING

FAILURE TO INSTALL AND MAINTAIN A NEW, LISTED 3/4" X 3/4" TEMPERATURE AND PRESSURE RELIEF VALVE WILL RELEASE THE MANUFACTURER FROM ANY CLAIM, WHICH MIGHT RESULT FROM EXCESSIVE TEMPERATURE AND PRESSURES.

If this water heater is installed in a closed water supply system, such as the one having a back-flow preventer in the cold water supply, provisions shall be made to control thermal expansion. **DO NOT** operate this water heater in a closed system without provisions for controlling thermal expansion. Your water supplier or local plumbing inspector should be contacted on how to control this situation.

After installation of the water lines, open the main water supply valve and fill the water heater. While the water heater is filling, open several hot water faucets to allow air to escape from the water system. When a steady stream of water flows through the faucets, close them and check all water connections for possible leaks. **NEVER OPERATE THE WATER HEATER WITHOUT FIRST BEING CERTAIN IT IS FILLED WITH WATER.**

▲WARNING

For protection against excessive temperatures and pressure, install temperature and pressure protective equipment required by local codes, but not less than a combination temperature and pressure relief valve certified by a nationally recognized testing laboratory that maintains periodic inspection of production of listed equipment or materials as meeting the requirements of the Standard for *Relief Valves and Automatic Gas Shutoff Devices for Hot Water Supply Systems, ANSI Z21.22* or the Standard *CAN1-4.4, Temperature and Pressure* and the Standard *CAN1-4.4, Temperature, Pressure, Temperature and Pressure Relief Valves and Vacuum Relief Valves*. The combination temperature and pressure relief valve shall be marked with a maximum set pressure not to exceed the maximum working pressure of the water heater. The combination temperature and pressure relief valve shall also have an hourly rated temperature steam BTU discharge capacity not less than the hourly rating of the water heater.

Install the combination temperature and pressure relief valve into the opening provided and marked for this purpose on the water heater.

Note: Some models may already be equipped or supplied with a combination temperature and pressure relief valve. Verify that the combination temperature and pressure relief valve complies with local codes. If the combination temperature and pressure relief valve does not comply with local codes, replace it with one that does. Follow the installation instructions above on this page.

Install a discharge line so that water discharged from the combination temperature and pressure relief valve will exit within six (6) inches (15.2 cm) above, or any distance below the structural floor and cannot contact any live electrical part. The discharge line is to be installed to allow for complete drainage of both the combination temperature and pressure relief valve and the discharge line. The discharge opening must not be subjected to blockage or freezing. **DO NOT** thread, plug or cap the discharge line. It is recommended that a minimum clearance of four (4) inches (10.2 cm) be provided on the side of the water heater for servicing and maintenance of the combination temperature and pressure relief valve.

Do not place a valve between the combination temperature and pressure relief valve and the tank.

▲WARNING

Hydrogen gas can be produced in an operating water heater that has not had water drawn from the tank for a long period of time (generally two weeks or more). **Hydrogen gas is extremely flammable.** To prevent the possibility of injury under these conditions, we recommend the hot water faucet to be open for several minutes at the kitchen sink before you use any electrical appliance, which is connected to the hot water system. If hydrogen is present, there will be an unusual sound such as air escaping through the pipes as hot water begins to flow. Do not smoke or have open flame near the faucet at the time it is open.

This water heater can deliver scalding temperature water at any faucet in the system. Be careful whenever using hot water to avoid scalding injury. Certain appliances such as dishwashers and automatic clothes washers may require increased temperature water. By setting the thermostat on this water heater to obtain the increased temperature water required by these appliances, the potential for scald injury increases. To protect against injury, you should install an ASSE approved mixing valve in the water system. This valve will reduce point of discharge temperature by mixing cold and hot water in branch supply lines. Such valves are available from the manufacturer of this water heater or a local plumbing supplier. Please consult with a plumbing professional.

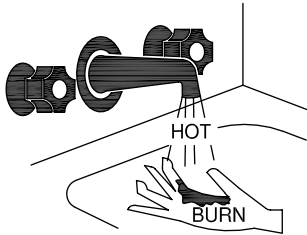
<p>▲ DANGER</p> 	<p>Water temperature over 125°F can cause severe burns instantly or death from scalds.</p> <p>Children, disabled and elderly are at highest risk of being scalded.</p> <p>Review this instruction manual before setting temperature at water heater.</p> <p>Feel water before bathing or showering.</p> <p>Temperature limiting valves are available.</p>
---	---

APPROXIMATE TIME/TEMPERATURE RELATIONSHIPS IN SCALDS	
120°F (49°C)	More than 5 minutes
125°F (52°C)	1½ to 2 minutes
130°F (54°C)	About 30 seconds
135°F (57°C)	About 10 seconds
140°F (60°C)	Less than 5 seconds
145°F (63°C)	Less than 3 seconds
150°F (66°C)	About 1½ seconds
155°F (68°C)	About 1 second

Gas Connections

The gas supply lines must meet all requirements of the National Fuel Gas Code (ANSI Z223.1-Latest Edition), or in Canada CAN/CGA B149.1 Natural Gas Installation Code (Latest Edition) or CAN/CGA B149.2 Propane Installation Code (Latest Edition).

The minimum permissible gas supply pressure for the purpose of input adjustment is one (1.0) inch (0.25 kPa) water column above the operating manifold pressure. See the rating plate and gas valve for the manifold pressure and gas type. The maximum permissible gas supply pressure is fourteen (14.0) inches (3.5 kPa) water column for natural gas and liquefied petroleum gases/propane gas.

1. Connect this water heater only to the type of gas (Natural or Propane gas) as shown on the rating plate. Use clean black iron pipe or equivalent material approved by local codes and ordinances. (Dirt and scale from the pipe can enter the gas valve and cause it to malfunction). The inlet gas line must have a minimum length of three (3) inches (7.6 cm) drip leg (*sediment trap*) installed as close to the water heater's gas valve as possible. A ground joint union must be installed as close to the water heater as possible in the gas supply line feeding the water heater to permit servicing of the water heater. Compounds used on the threaded joints of the gas piping must be resistant to the action of liquefied petroleum gases/propane gas. DO NOT apply pipe dope to the gas valve inlet and make certain that no pipe dope has become lodged in the inlet screen of the gas valve. Extreme care must be taken to ensure no pipe dope enters the gas valve. Avoid excessive torque when tightening the gas supply line to the gas valve. Excessive torque may result in cracking of the gas valve housing and could create a gas leak. When tightening gas supply line to L.P. control, it is recommended to hold the inlet body of the control securely with an adequate wrench. The suggested maximum torque is 31.5 ft. lbs. (4.4 kg-m).

WARNING

The manufacturer of this water heater will not be liable for any damage or injury caused as a result of a cracked gas inlet as a result of excessive torque.

2. This water heater and its gas connection must be leak tested before placing the water heater in operation. Check for gas leaks with a soap and water solution and a brush or a commercial leak detector fluid. **NEVER USE A MATCH OR OPEN FLAME FOR TESTING!**

CAUTION

The water heater and individual shutoff valve must be disconnected from the gas supply piping system during any pressure testing of the system at test pressures in excess of 1/2 psi (3.5 kPa). The water heater must be isolated from the gas supply piping system by closing its manual shutoff valve during any pressure testing of the gas supply system at test pressures equal to or less than 1/2 psi (3.5 kPa). The supply line must be capped when not connected to the water heater.

3. While checking for leaks care must be taken to prevent solution from contacting the electrical connections at the control. If electrical connections at the control become wet, they must be thoroughly dried before attempting to operate the water heater.

GENERAL OPERATION



Water heaters are heat producing appliances. To avoid damage or injury there shall be no materials stored against the water heater or vent-air intake system, and proper care shall be taken to avoid unnecessary contact (especially by children) with the water heater and vent-air intake system.



UNDER NO CIRCUMSTANCES SHALL FLAMMABLE MATERIALS, SUCH AS GASOLINE OR PAINT THINNER BE USED OR STORED IN THE VICINITY OF THIS WATER HEATER, VENT-AIR INTAKE SYSTEM OR IN ANY LOCATION FROM WHICH FUMES COULD REACH THE WATER HEATER OR VENT-AIR INTAKE SYSTEM.

TO FILL THE WATER HEATER

1. Close the water heater drain valve by turning the knob clockwise .
2. Open the cold water supply shut-off valve.
3. Open several hot water faucets to allow air to escape from the system.
4. When a steady stream of water flows from the faucets, the water heater is filled. Close the faucets and check for water leaks at the water heater drain valve, combination temperature and pressure relief valve and the hot and cold water connections.

TO DRAIN THE WATER HEATER

Should it become necessary to completely drain the water heater, make sure you follow the steps below:

1. Rotate the thermostat dial clockwise  to the lowest possible position.
2. Rotate and partially depress gas control knob clockwise  to the "OFF" position.
3. Shut off the gas supply to the water heater.
4. Close the cold water supply shut-off valve.
5. Open the drain valve on the water heater by turning the knob counter-clockwise . The drain valve has threads on the end that will allow the connection of a standard hose coupling.
6. Open a hot water faucet to allow air to enter the system.

To refill the water heater, refer to "To Fill the Water Heater."



Lighting and Shutdown Instructions-White Rodgers and Robertshaw gas control.

FOR YOUR SAFETY READ BEFORE LIGHTING

WARNING: If you do not follow these instructions exactly, a fire or explosion may result causing property damage, personal injury or loss of life.

- A. This appliance has a pilot which is lit by a piezo-electric spark gas ignition system. Do not open the inner door and attempt to light the pilot by hand.
- B. **BEFORE LIGHTING** smell all around the appliance area for gas. Be sure to smell next to the floor because some gas is heavier than air and will settle on the floor.
WHAT TO DO IF YOU SMELL GAS.
 - * Do not try to light any appliance.
 - * Do not touch any electric switch; do not use any phone in your building.
 - * Immediately call your gas supplier from a neighbor's phone. Follow the gas supplier's instructions.
 - * If you cannot reach your gas supplier, call the fire department.
- C. Use only your hand to push in or turn the gas control knob. Never use tools. If the knob will not push in or turn by hand, don't try to repair it, call a qualified service technician. Force or attempted repair may result in a fire or explosion.
- D. Do not use this appliance if any part has been under water. Immediately call a qualified service technician to inspect the appliance and to replace any part of the control system and any gas control which has been under water.

LIGHTING INSTRUCTIONS

1. **STOP!** Read the safety information above on this label.
2. Set the thermostat to lowest setting.
3. Rotate and if applicable partially depress gas control knob clockwise  to "OFF" position.
8. Turn the gas control knob counterclockwise  to "PILOT" position.

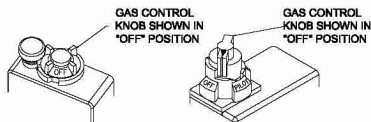

EXHIBIT A

EXHIBIT B

NOTE: On exhibit B, knob cannot be turned from "PILOT" to "OFF" unless knob is depressed slightly. Do not force.

4. Wait five (5) minutes to clear out any gas. Then smell for gas, including near the floor. If you smell gas, **STOP!** Follow "B" in the safety information above on this label. If you don't smell gas, go to the next step.

5. Remove outer door.
6. Locate piezo igniter button.
7. Look into sight glass window on inner door to view pilot.

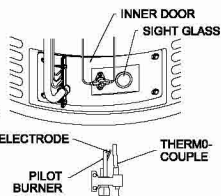

- 9a. **FOR EXHIBIT A GAS CONTROLS-** Depress and hold down red pilot set button. Immediately depress piezo igniter button until you hear a "click" sound, then release. Continue to hold down the pilot set button for about one (1) minute after the pilot is lit. Release the pilot set button and it should pop back up. Pilot should remain lit. If it goes out, repeat steps 3 through 9.

- 9b. **FOR EXHIBIT B GAS CONTROLS-** Depress and hold down gas control knob. Immediately depress piezo igniter button until you hear a "click" sound, then release. Continue to hold down the knob for about one (1) minute after the pilot is lit. Release the knob and it should pop back up. Pilot should remain lit. If it goes out, repeat steps 3 through 9.

FOR EXHIBIT A & B GAS CONTROLS-

- If button or knob does not pop up when released, stop and immediately call your service technician or gas supplier.
- If the pilot will not stay lit after several tries, turn the gas control knob to "OFF" and call your technician or gas supplier.

10. Replace outer door.
11. Turn gas control knob counterclockwise  to "ON" position.
12. Set thermostat to desired setting.

TO TURN OFF GAS TO APPLIANCE

1. Set the thermostat dial to lowest possible setting.
2. Rotate and if applicable partially depress gas control knob clockwise  to "OFF" position.

Lighting and Shutdown Instructions-Honeywell gas control.

FOR YOUR SAFETY READ BEFORE LIGHTING

WARNING: If you do not follow these instructions exactly, a fire or explosion may result causing property damage, personal injury or loss of life.

- A. This appliance has a pilot which is lit by a piezo-electric spark gas ignition system. Do not open the inner door and attempt to light the pilot by hand.
- B. **BEFORE LIGHTING** smell all around the appliance area for gas. Be sure to smell next to the floor because some gas is heavier than air and will settle on the floor.
WHAT TO DO IF YOU SMELL GAS.
 - * Do not try to light any appliance.
 - * Do not touch any electric switch; do not use any phone in your building.
 - * Immediately call your gas supplier from a neighbor's phone. Follow the gas supplier's instructions.
 - * If you cannot reach your gas supplier, call the fire department.
- C. Use only your hand to push in or turn the gas control knob. Never use tools. If the knob will not push in or turn by hand, don't try to repair it, call a qualified service technician. Force or attempted repair may result in a fire or explosion.
- D. Do not use this appliance if any part has been under water. Immediately call a qualified service technician to inspect the appliance and to replace any part of the control system and any gas control which has been under water.

LIGHTING INSTRUCTIONS

1. **STOP!** Read the safety information above on this label.
2. Set the gas control knob to the "OFF" position.

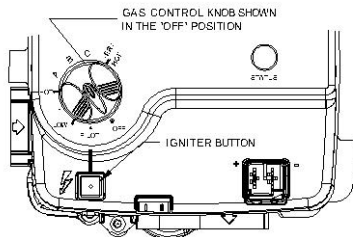

3. Wait five (5) minutes to clear out any gas. Then smell for gas, including near the floor. If you smell gas, **STOP!** Follow "B" in the safety information above on this label. If you don't smell gas, go to the next step.

4. Remove outer door.
5. Locate igniter button.
6. Look through sight glass window on inner door to view pilot.

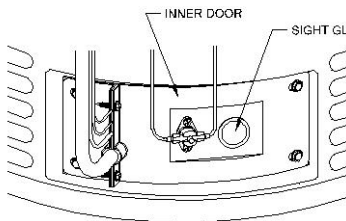

7. Turn the gas control knob clockwise  to "PILOT" position.

8. Depress and hold in gas control knob. Immediately press igniter button until you hear a "click" sound, then release. Continue to hold down the gas control knob until the status light blinks. Release the gas control knob. It should pop back out. Check to see if the pilot is still lit. If the pilot goes out, repeat steps 2 through 8.

- If gas control knob does not pop out when released, stop and immediately call your service technician or gas supplier.
- If the pilot will not stay lit after several tries, turn the gas control knob to "OFF" and call your technician or gas supplier.

9. Replace outer door.
10. Turn gas control knob to desired setting.

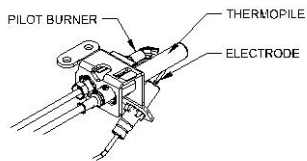

TO TURN OFF GAS TO APPLIANCE

1. Turn the gas control knob counterclockwise  to the "OFF" position.

THERMOSTAT ADJUSTMENT - White Rodgers gas control.

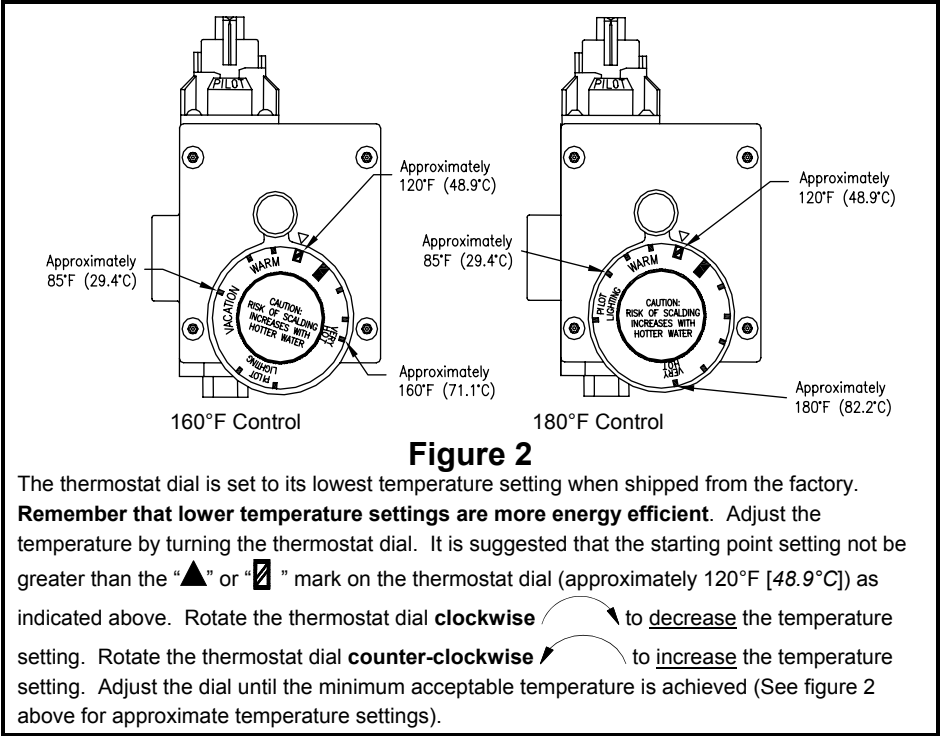

Robertshaw gas control.

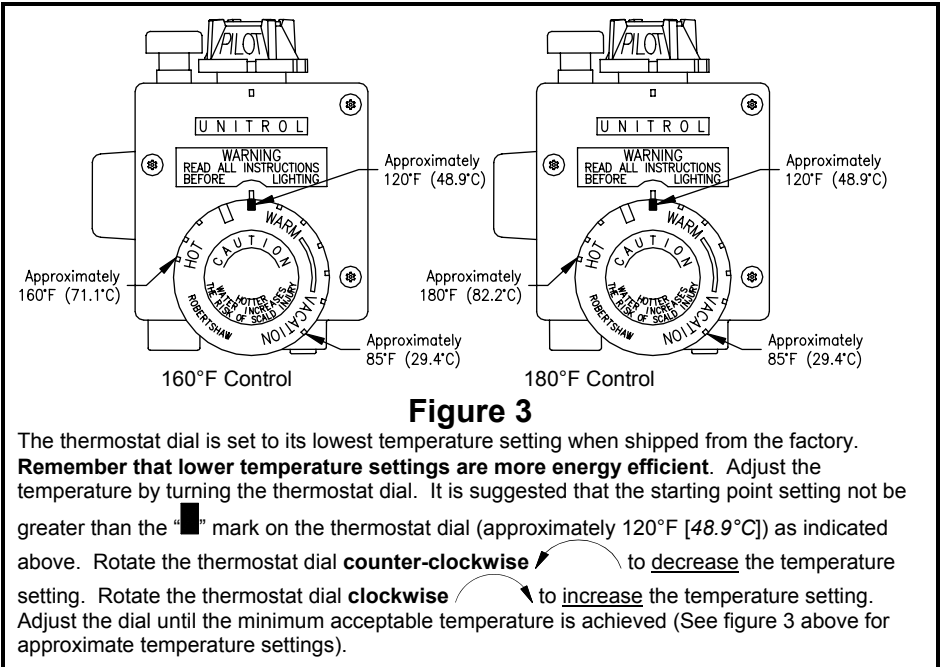

THERMOSTAT ADJUSTMENT - Honeywell gas control.

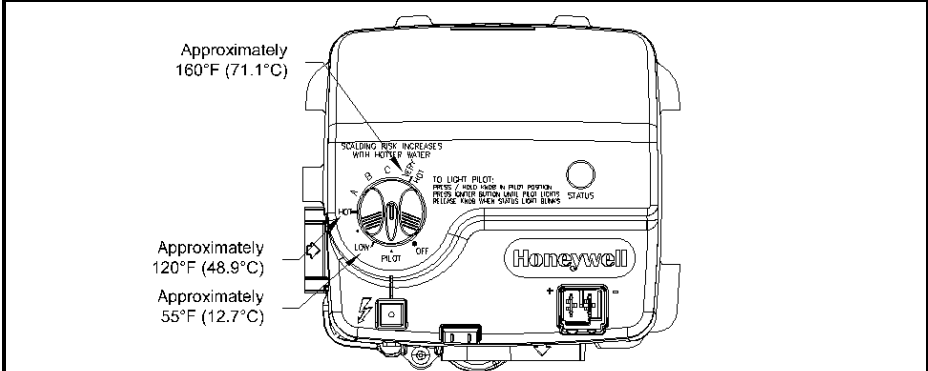

160°F (71.1°C) Control

Figure 4

The thermostat dial is set to its lowest temperature setting when shipped from the factory. **Remember that lower temperature settings are more energy efficient.** Adjust the temperature by turning the thermostat dial. It is suggested that the starting point setting not be greater than the “HOT” mark on the thermostat dial (approximately 120°F [48.9°C]) as indicated above. Rotate the thermostat dial **counter-clockwise** to decrease the temperature setting. Rotate the thermostat dial **clockwise** to increase the temperature setting. Adjust the dial until the minimum acceptable temperature is achieved (See figure 4 above for approximate temperature settings).

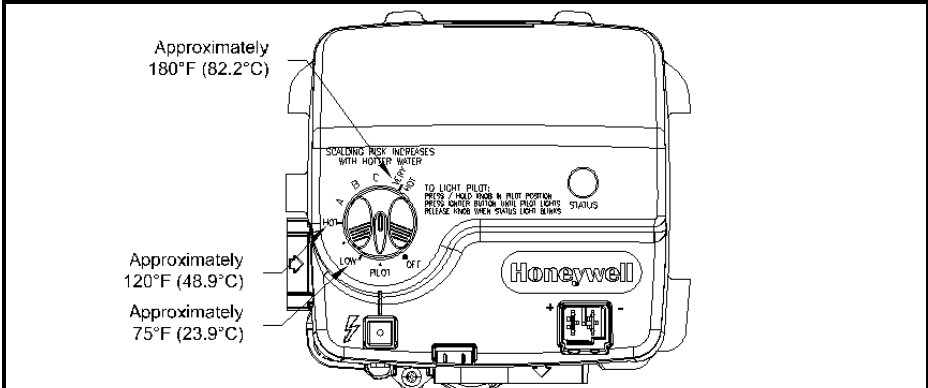

Figure 5

The thermostat dial is set to its lowest temperature setting when shipped from the factory. **Remember that lower temperature settings are more energy efficient.** Adjust the temperature by turning the thermostat dial. It is suggested that the starting point setting not be greater than the “HOT” mark on the thermostat dial (approximately 120°F [48.9°C]) as indicated above. Rotate the thermostat dial **counter-clockwise** to decrease the temperature setting. Rotate the thermostat dial **clockwise** to increase the temperature setting. Adjust the dial until the minimum acceptable temperature is achieved (See figure 5 above for approximate temperature settings).

General Operation continued-

⚠ DANGER

Hotter water increases the risk of scald injury. Scalding may occur within five (5) seconds at a temperature setting of 140°F (60°C). To protect against hot water injury, install an ASSE approved mixing valve in the water system. This valve will reduce point of discharge temperature by mixing cold and hot water in branch water lines. A licensed plumbing professional or local plumbing authority should be consulted.

Note: This water heater is equipped with an energy cut out device to prevent overheating. Should overheating occur or the gas supply fail to shut off, turn off the manual gas control valve to the appliance and call a qualified service technician.

Note: Whenever the water heater is filled with cold water, condensate will form on the cool tank surface and drops of water will fall on the hot burner and combustion chamber surfaces producing a “sizzling” noise.

Condensation is normal and does not indicate a leak. It will disappear when the tank becomes heated.

BURNER FLAME CHECKS

Steel Burner: These models are equipped with self adjusting air mixture and do not have an adjustable air shutter (See Figure 6). At periodic intervals, a visual check of the main burner and pilot flames should be made to determine if they are burning properly. The main burner flame should light smoothly from the pilot.

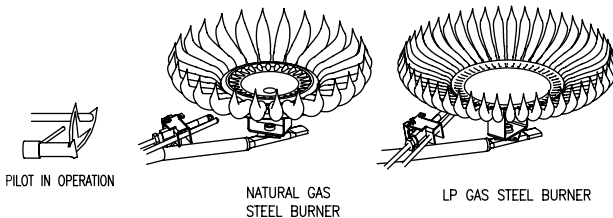

Figure 6

MAINTENANCE

WARNING

Water heaters are heat producing appliances. To avoid damage or injury there shall be no materials stored against the water heater or vent-air intake system, and proper care shall be taken to avoid unnecessary contact (especially by children) with the water heater and vent-air intake system.

UNDER NO CIRCUMSTANCES SHALL FLAMMABLE MATERIALS, SUCH AS GASOLINE OR PAINT THINNER BE USED OR STORED IN THE VICINITY OF THIS WATER HEATER, VENT-AIR INTAKE SYSTEM OR IN ANY LOCATION FROM WHICH FUMES COULD REACH THE WATER HEATER OR VENT-AIR INTAKE SYSTEM.

IMPORTANT

The water heater should be inspected at a minimum annually by a qualified service technician for damaged components and/or joints not sealed. DO NOT operate this water heater if any part is found damaged or if any joint is found not sealed.

The following maintenance should be performed by a qualified service technician at the minimum periodic intervals suggested below. In some installations, the maintenance interval may be more frequent depending on the amount of use and the operating conditions of the water heater. Regular inspection and maintenance of the water heater and vent-air intake system will help to insure safe and reliable operation.

1. Annually check the operation of the thermostat.
2. The flow of combustion and ventilation air **MUST NOT** be restricted. Make sure slots in jacket are open and unobstructed. Clear jacket slot openings of any dirt, dust, or other restrictions. **WARNING!** The ventilation air system may be **HOT**.
3. At all times keep the water heater area clear and free from combustible materials, gasoline and other flammable vapors and liquids.
4. Bi-annually conduct a visual check of the main and pilot burner flames to determine that they are burning properly. See Burner Flame Check section of this installation and operation manual. If sooting or other burner anomalies are evident, shut down the water heater by turning off the gas per the instructions listed in this manual or as listed on the water heater.
5. Annually remove the inner door and main burner assembly to clean orifices and related parts of any dirt or other foreign material. Inspect the burner ports for obstructions or debris and clean with a wire brush as needed. Wire brush and/or vacuum clean the combustion chamber as needed to remove scale deposits and debris. **NOTE:** It is imperative for proper operation of the water heater that the inner door be replaced in the original location, making certain the resettable thermal switch is properly connected to the gas control wire leads provided.

▲WARNING

- Do not operate water heater with jumpered, altered, loosely tightened or absent controls and/or components.
- Do not operate water heater with replacement controls and/or components, which are not exact duplicates or original equipment.
- Thoroughly inspect and replace, (as needed) burner inner door gasket and/or sight window gasket any time burner inner door is removed or disturbed.
- Replace water heater if involved in flammable vapors incident.

▲WARNING

When lifting lever of the combination temperature and pressure relief valve, hot water will be released under pressure. Be careful that any released water does not result in bodily injury or property damage.

6. At least once a year, check the combination temperature and pressure relief valve to insure that the valve has not become encrusted with lime. Lift the lever at the top of the valve several times until the valve seats properly without leaking and operates freely.

▲WARNING! THIS WATER MAY BE HOT.

7. Monthly drain off a gallon of water to remove silt and sediment.
8. If the combination temperature and pressure relief valve on the appliance discharges periodically, this may be due to thermal expansion in a closed water supply system. Contact the water supplier or local plumbing inspector on how to correct this situation. Do not plug the combination temperature and pressure relief valve outlet.
9. A combination sacrificial anode rod/hot water outlet nipple has been installed to extend tank life. The anode rod should be inspected periodically (every 2 years) and replaced when necessary to prolong tank life. Water conditions in your area will influence the time interval for inspection and replacement of the anode rod. Contact the plumbing professional who installed the water heater or the manufacturer listed on the rating plate for anode replacement information. The use of a water softener may increase the speed of anode consumption. More frequent inspection of the anode is needed when using softened (or phosphate treated) water.
10. The vent system must be inspected at least once a year to ensure against leakage of exhaust products.

▲ CAUTION

FOR YOUR SAFETY, **DO NOT** ATTEMPT REPAIR OF COMBINATION GAS CONTROL, BURNERS OR GAS PIPING. REFER REPAIRS TO A QUALIFIED SERVICE TECHNICIAN.

Contact your supplier or plumbing professional for replacement parts or contact the company at the address given on the rating plate of the water heater.

Provide the part name, model and serial numbers of the water heater when ordering parts.

READ THE WARRANTY FOR A FULL EXPLANATION OF THE LENGTH OF TIME THAT PARTS AND THE WATER HEATER ARE WARRANTED.

Manufactured under one or more of the following U.S. Patents: RE.34,534; B1 5,341,770; 4,416,222; 4,628,184; 4,669,448; 4,672,919; 4,808,356; 4,829,983; 4,861,968; 4,904,428; 5,000,893; 5,023,031; 5,052,346; 5,081,696; 5,092,519; 5,115,767; 5,199,385; 5,277,171; 5,372,185; 5,485,879; 5,574,822; 5,596,952; 5,660,165; 5,682,666; 5,761,379; 5,943,984; 5,954,492; 5,988,117; 6,142,216; 6,395,280; 6,684,821; 7,063,132; 7,007,748
Other U.S. and Foreign patent applications pending. Current Canadian Patents: 1,272,914; 1,280,043; 1,289,832; 2,045,862; 2,092,105; 2,107,012; 2,108,186; 2,112,515

Complete the following information and retain for future reference:

Model No: _____

Serial No: _____

Service Phone
Days: _____ Nights: _____

Address: _____

Supplier: _____

Supplier Phone No: _____

TROUBLESHOOTING CHART

LED Status	Control Status	Probable Cause
None (LED not on or flashing)	Millivolt power is not present. Light pilot.	<ol style="list-style-type: none"> 1. Gas valve is functioning normally 2. Gas valve is not powered. Light pilot
One flash and three second pause.	If set point knob is in "PILOT" position then pilot flame is detected. (no faults) .	Gas valve is powered and waiting for the set point knob to be turned to a water temperature setting. If the set point knob is at desired setting the thermostat is satisfied.
LED strobe (two quick flashes) and three second pause	Thermostat calling for heat (no faults)	Water heater operating normally.
LED on continuously.	Set point knob has been recently turned to the "OFF" position.	Set point knob was recently turned to "OFF" position. Wait until LED goes out before attempting to relight
Two flashes and three second pause.	Weak pilot flame detected. System will reset when pilot flame is sufficient.	<ol style="list-style-type: none"> 1. Unstable pilot. 2. Pilot tube blocked or restricted.
Three flashes and three second pause.	Insufficient water heating. System will reset.	<ol style="list-style-type: none"> 1. Temperature sensor out of calibration. 2. Possible short.
Four flashes and three second pause.	Excessive tank temperature. System must be reset.	<ol style="list-style-type: none"> 1. Temperature sensor out of calibration. 2. Faulty gas valve.
Five flashes and three second pause.	Temperature Sensor fault.	<ol style="list-style-type: none"> 1. Damage to the temperature wire. 2. Temperature sensor resistance out of range. 3. Replace temperature sensor. 4. If temperature sensor replacement does not correct the problem; Verify control is not wet or physically damaged 5. Turn set point knob to "OFF" position. Turn set point knob to "PILOT" position and light pilot. 6. Replace gas valve if five flash error persists.

TROUBLESHOOTING CHART (CONTINUED)

LED Status	Control Status	Probable Cause
Six flashes and three second pause.	Water leak detected by accessory module (some models).	Excessive amount of water in drain pan/water dam.
Seven flashes and three second pause.	Gas valve electronic fault detected.	<ol style="list-style-type: none">1. Verify control is not wet or physically damaged.2. Turn set point knob to "OFF" position. Turn set point knob to "PILOT" position and light pilot.3. Replace gas valve if seven flash error persists.
Eight flashes and three second pause	False pilot flame present.	<ol style="list-style-type: none">1. Pilot valve stuck in open position2. Turn set point knob to "OFF" position. Turn set point knob to "PILOT" position and light pilot.3. Replace gas valve if eight flash error persists.

INSTALLATION FOR POTABLE WATER

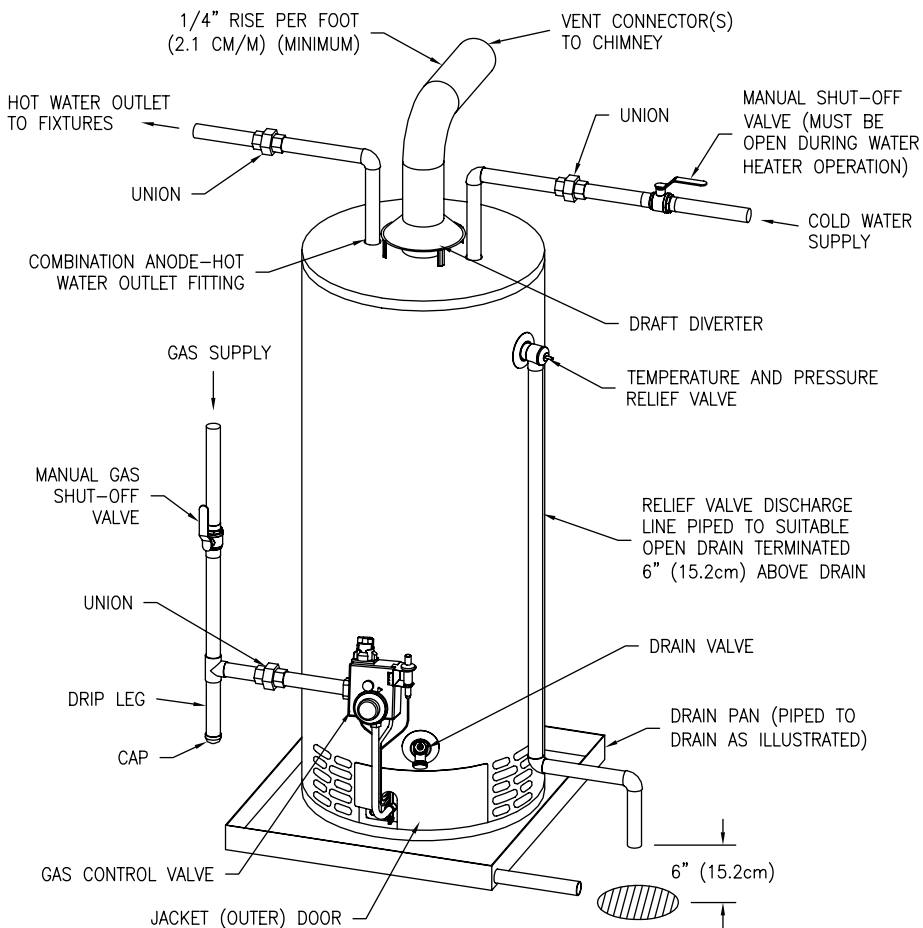
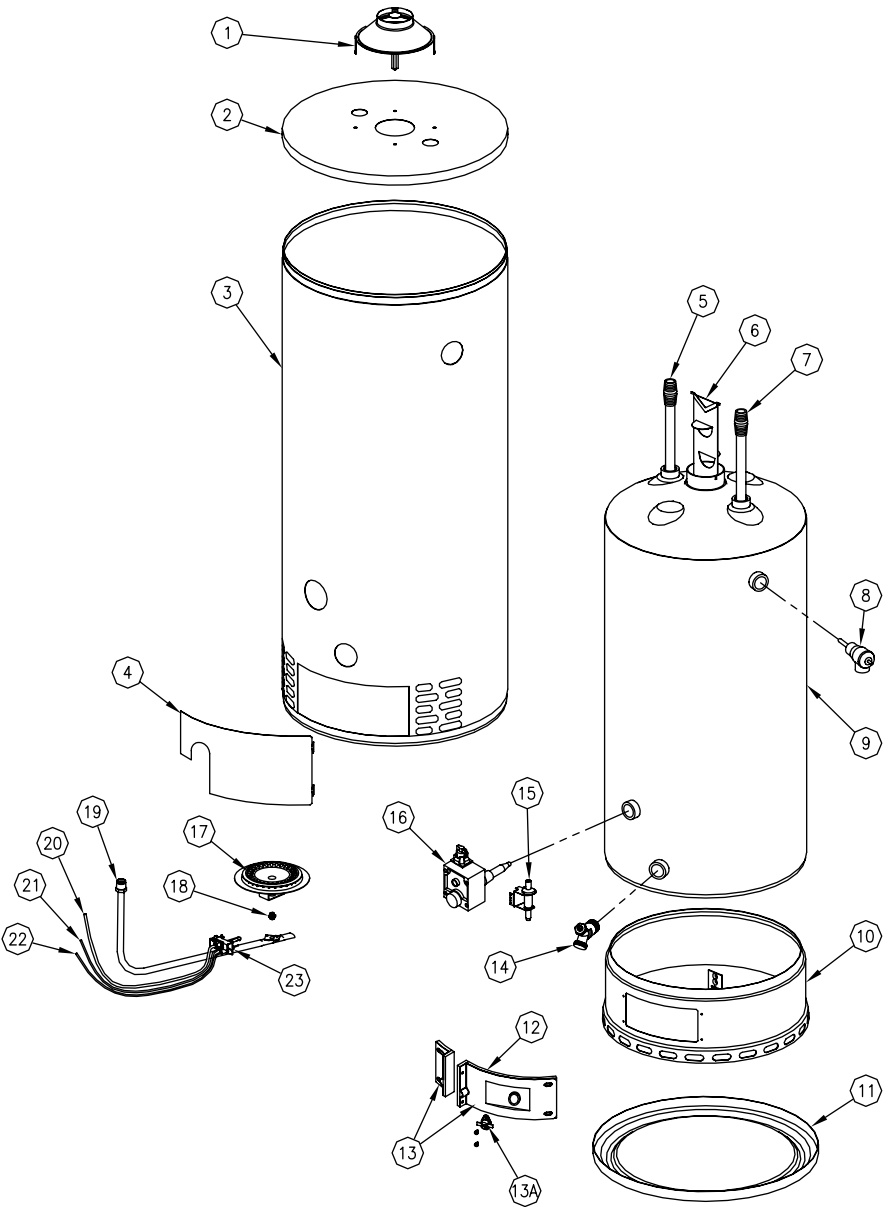

Figure 7

PARTS LIST DRAWING



PARTS LIST

PART NAME AND DESCRIPTION	
1. Draft Diverter	14. Drain Valve
2. Jacket Head Pan	15. Piezo Igniter
3. Jacket	16. Gas Valve
4. Outer Door	17. Steel Burner
5. Magnesium Anode–Hot Water Outlet	18. Orifice
6. Flue Baffle Assembly	19. Gas Feedline to Burner
7. Dip Tube–Cold Water Inlet	20. Gas Feedline to Pilot
8. Temperature and Pressure Relief Valve	21. Thermocouple Lead
9. Glass Lined Tank	22. Piezo Igniter Lead
10. Combustion Chamber Assembly	23. Pilot Assembly
11. Jacket Base Pan	
12. Inner Door Gasket	
13. Inner Door Assembly	
13A. High temperature limit switch	

**THE FOLLOWING INSTRUCTIONS ARE FOR INSTALLATION OF:
GAS WATER HEATERS
SUITABLE FOR WATER (POTABLE) HEATING AND SPACE
HEATING**

1. All piping components connected to this water heater for space heating applications must be suitable for use with potable water. In Massachusetts, space heating piping length **must not** exceed 50 feet.
2. Toxic chemicals, such as those used for boiler treatment, **must not** be introduced into potable water used for space heating.
3. This water heater **must not** be connected to an existing heating system or component(s) previously used with a non-potable water heating appliance.
4. When the system requires water for space heating at temperatures higher than required for other means, such as an ASSE approved mixing valve must be installed to temper the water for those uses in order to reduce the scald hazard potential.

Please refer to figure 8 and figure 9 for suggested piping arrangements.

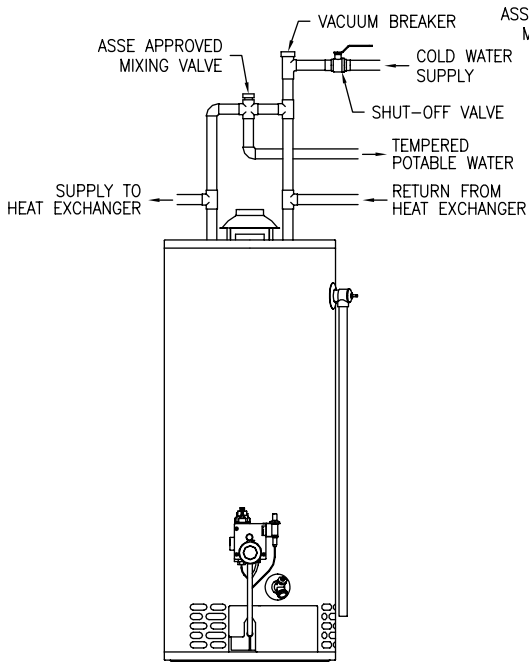

Figure 8

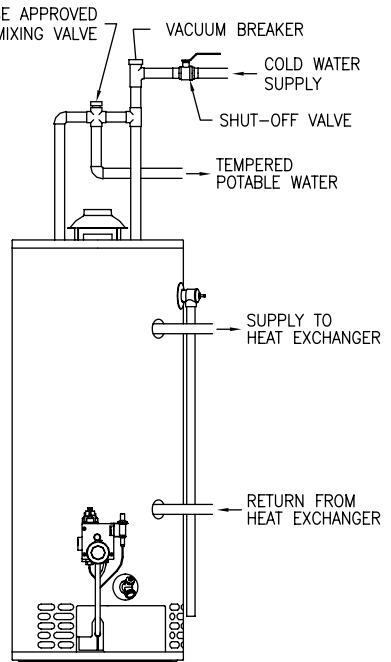

Figure 9

NOTES



BRADFORD WHITE[®]
W A T E R H E A T E R S

**Flammable Vapor Ignition
Resistant Water Heaters**

Gas Water Heaters



SERVICE **MANUAL**

**Troubleshooting Guide
and Instructions for Service**

(To be performed ONLY by
qualified service providers)

FEATURING
BRADFORD WHITE
DEFENDER **ICON**
SAFETY SYSTEM[®] System[™]

**For the Bradford White
Defender Safety System[®]
Models:**

MI30T*F(BN,CX,SX)	M430T*F(BN,CX,SX)
MI30S*F(BN, CX,SX)	M440T*F(BN, CX,SX)
MI303T*F(BN,CX,SX)	M4403S*F(BN,CX,SX)
MI40T*F(BN,CX,SX)	M4503*F(BN,CX,SX)
MI403S*F(BN,CX,SX)	M460T*F(BN,CX,SX)
MI404T*F(BN,CX,SX)	M1XR403S*F(BN,CX,SX)
MI503*F(BN,CX,SX)	M1XR504T*F(BN,CX,SX)
MI50L*F(BN,CX,SX)	M2XR504T*F(BN,CX,SX)
MI504S*F(BN,CX,SX)	M2XR65T*F(BN,CX,SX)
MI60T*F(BN,CX,SX)	M2C504T*F(BN,CX,SX)
C(S,D)W2504T*F(BN,CX,SX)	50T65F(B*N,C*X,S*X)
	65T65F(B*N,C*X,S*X)

(* Denotes Warranty Years)



Flammable Vapor Ignition Resistant Water Heaters

Table of Contents

	<u>Page</u>	<u>Service Procedure</u>
Introduction	3	---
Trouble shooting Chart	4	---
Inner Door Gasket Removal, Inspection, Replacement and Installation	7	RG-I
Thermocouple/Thermopile Testing and Replacement	10	RG-II
Pilot Assembly Inspection Cleaning and Replacement	13	RG-III
Piezo Igniter, Electrode Testing and Replacement	14	RG-IV
White Rodgers/Robertshaw Gas Valve Testing and Replacement	15	RG-V
Honeywell Gas Control Testing, Disassembly, and Replacement	20	RG-VI
Burner Operation Inspection, Adjustment, Cleaning and Replacement	31	RG-VII
Resettable Thermal Switch Testing and Replacement	34	RG-VIII
ScreenLok® Flame Arrestor Cleaning	36	RG-IV
Dip Tube and Anode Inspection and Replacement	37	RG-X
Generic Parts List	39	---

INTRODUCTION

The Bradford White DEFENDER Safety System®

The Bradford White DEFENDER Safety System® was designed to resist the ignition of flammable vapors that can occur outside of the water heater. Use and installation are nearly identical to previous versions of atmospherically fired and vented water heaters. A number of exclusive design features are incorporated in the system that will require additional knowledge on the part of the qualified service provider. The following information will instruct service professionals on the function, proper diagnosis and repair of water heaters employing the Bradford White DEFENDER Safety System.

How the Safety System Works

During normal operation, air for combustion is drawn into the water heater through the opening in the jacket. This air travels down and around the combustion chamber and enters through holes in the very bottom of the corrosion-resistant combustion chamber. The air then travels up through the oriented flame arrestor plate louvers, where the velocity of the air is increased and its direction altered. The air then mixes in a normal manner with the supplied gas and is efficiently combusted, producing very low NOx emissions.

In the case where trace amounts of flammable vapors are present in the air flowing into the combustion chamber, the vapors are harmlessly ignited by the burner / pilot flame. If flammable vapors are in sufficient quantity to prevent normal combustion, the burner/pilot flame is shut down.

Should the flammable vapors continue to the burner, the flame arrestor plate prevents the flames from traveling backwards and igniting vapors outside of the combustion chamber. The calibrated, multipurpose thermal switch recognizes this and shuts down the pilot and main burner. This switch also deactivates the burner and pilot in the unlikely event of restricted airflow caused by severe lint, dust or oil accumulation on the arrestor plate.

White Rodgers/Robertshaw Gas Valve Troubleshooting Chart

Flammable Vapor Ignition Resistant Water Heaters

<u>SYMPTOM</u>	<u>PROBABLE CAUSE</u>	<u>CORRECTIVE ACTION</u>	<u>SERVICE PROCEDURE</u>
Pilot Will Not Light	<ol style="list-style-type: none"> 1. No incoming gas or too low gas pressure. 2. Gas control knob set to wrong position. 3. Pilot light button not being fully depressed when attempting to light pilot. 4. Pilot orifice or pilot tube is obstructed or kinked. 5. Pilot electrode not sparking to pilot. 6. Piezo igniter not functioning. 	<ol style="list-style-type: none"> 1. Turn on gas supply and/or check line pressure. 2. Review lighting instruction. Set combination/thermostat gas valve to correct position. 3. Review lighting instruction. Fully depress pilot lighting button. 4. Clean, repair or replace. 5. Verify correct electrode position. Replace pilot assembly. 6. Replace Piezo igniter. 	<ol style="list-style-type: none"> 1. See Service Procedure RG-V, Page 12. 4. See Service Procedure RG-III, Page 10. 5. See Service Procedure RG-III, Page 10. 6. See Service Procedure RG-IV, Page 11.
Pilot Will Not stay lit when button is released	<ol style="list-style-type: none"> 1. Poor thermocouple connection at combination thermostat/gas valve. 2. Thermocouple not fully engaged in pilot assembly bracket. 3. Pilot flame is not fully enveloping the thermocouple "hot" junction. 4. Weak or defective thermocouple. 5. Open ECO on combination thermostat/gas valve. 6. Defective magnet in combination thermostat/gas valve. 7. Resettable thermal switch has opened. 	<ol style="list-style-type: none"> 1. Check connection at combination thermostat/gas valve. Proper tightness should be finger tight plus ¼ turn. 2. Inspect thermocouple to ensure that it is fully engaged into pilot bracket. 3. Adjust tip of thermocouple to be fully engulfed by pilot flame. 4. Check thermocouple and replace if necessary. 5. Check ECO continuity and replace combination thermostat/gas valve if necessary. 6. Check magnet operation and replace combination thermostat/gas valve if necessary. 7. Determine cause of switch activation. To reset, depress button on resettable thermal switch located on inner door. 	<ol style="list-style-type: none"> 4. See Service Procedure RG-II, Page 8 5. See Service Procedure RG-V, Page 14 6. See Service Procedure RG-V, Page 13
Pilot will light but the main burner will not come on	<ol style="list-style-type: none"> 1. Combination thermostat/gas valve set too low for desired water temperature. 2. Combination thermostat/gas valve temperature is satisfied. 3. Insufficient gas supply or low gas pressure. 4. Combination thermostat/gas valve has wide differential or is out of calibration. 	<ol style="list-style-type: none"> 1. Adjust temperature dial on combination thermostat/gas valve. 2. Check temperature dial setting on combination thermostat/gas valve. 3. Check gas supply and line pressure. 4. Check combination thermostat/gas valve for proper operation, replace if necessary. 	<ol style="list-style-type: none"> 2. See Installation & operation manual. 3. See Service Procedure RG-V, Page 12 4. See Service Procedure RG-V, Page 12
Pilot goes out periodically (after heating cycles, once a day, once a week etc.)	<ol style="list-style-type: none"> 1. Insufficient combustion air supply. 2. Incorrect, clogged vent system/ vent terminal or location. 3. Inconsistent gas supply or gas pressure. 	<ol style="list-style-type: none"> 1. Verify adequate combustion air is available to the unit. Check and clear Jacket slot openings of any dirt, dust, restrictions or other obstructions. Inspect flame arrestor plate and clean with stiff bristled brush and/or vacuum to remove any debris accumulation. 2. Check venting for proper sizing and proper operation 3. Check gas supply and line pressure. 	<ol style="list-style-type: none"> 1. See Service Procedure RG-VIII, Page 22 3. See Service Procedure RG-V, Page 12
Not enough hot water	<ol style="list-style-type: none"> 1. Combination thermostat/gas valve set too low for desired water temperature. 2. Cold inlet water temperature is very cold. 3. High demand periods. 4. Incorrectly sized water heater for application. 5. Combination thermostat/gas valve is out of calibration/not functioning. 6. Out of spec dip tube is diluting hot water with cold water. 	<ol style="list-style-type: none"> 1. Check dial on combination thermostat/gas valve. 2. Extremely cold water going into the heater will decrease the amount of hot water produced. It may be necessary to temper incoming water supply. 3. Adjust high demand usage. 4. Contact Plumbing professional. 5. Check combination thermostat/gas valve for proper operation, replace if necessary. 6. Inspect dip tube and replace if necessary. 	<ol style="list-style-type: none"> 5. See Service Procedure RG-V, Page 12 6. See Service Procedure RG-IX, Page 23

Honeywell Gas Control Troubleshooting Chart

Flammable Vapor Ignition Resistant Water Heaters

Observe green LED indicator on Gas Control. Error flash codes are displayed with a three second pause before repeating. Check and repair the system as noted in the troubleshooting table below.



Green LED Indicator

<u>LED Status</u>	<u>Control Status</u>	<u>Probable Cause</u>	<u>Service Procedure</u>
None (LED not on or flashing)	Gas Control is operating normally. Pilot flame may not be present. Check for pilot flame through sight glass and light if necessary.	<ol style="list-style-type: none"> 1. Gas Control is functioning normally. 2. Gas Control is not powered. Light pilot. 3. Thermopile failure. 	If the pilot will not stay lit replace pilot assembly. If problem persists replace Gas Control.
One flash and three second pause	If set point knob is in "PILOT" position then pilot flame is detected. Turn set point knob to desired setting.	Gas Control is powered and waiting for the set point knob to be turned to a water temperature setting.	Normal operation. Adjust thermostat to desired temperature setting.
LED on continuously (Solid)	Set point knob has been recently turned to the "OFF" position. Wait until LED goes out before attempting to relight	Set point knob was turned to "OFF" position.	LED will go out and the control will function normally when the pilot is lit.
Two flashes and three second pause	Weak pilot signal detected. System will reset when pilot flame is sufficient.	<ol style="list-style-type: none"> 1. Thermopile failure 2. Unstable pilot 3. Pilot tube block or restricted. 4. Resettable thermal switch has opened 	<ol style="list-style-type: none"> 1. See service procedure RG-II 2. See service procedure RG-III 3. See service procedure RG-III 4. See service procedure RG-VIII
Three flashes and three second pause	Insufficient water heating. System will reset.	<ol style="list-style-type: none"> 1. Temperature sensor out of calibration 	<ol style="list-style-type: none"> 1. See service procedure RG-VI
Four flashes and three second pause	Excessive tank temperature. System must be reset.	<ol style="list-style-type: none"> 1. Temperature sensor out of calibration 2. Faulty Gas Control 	<ol style="list-style-type: none"> 1. See service procedure RG-VI 2. See service procedure RG-VI

Honeywell Gas Control Troubleshooting Chart

Flammable Vapor Ignition Resistant Water Heaters

Observe green LED indicator on Gas Control. Error flash codes are displayed with a three second pause before repeating. Check and repair the system as noted in the troubleshooting table below.



Green LED Indicator

<u>LED Status</u>	<u>Control Status</u>	<u>Probable Cause</u>	<u>Service Procedure</u>
Five flashes and three second pause	Thermostat/well sensor fault.	<ol style="list-style-type: none"> 1. Damage to the temperature sensor. 2. Temperature sensor resistance out of range. 	<ol style="list-style-type: none"> 1. See service procedure RG-VI
Six flashes and three second pause	Water leak detected by accessory module.	Excessive amount of water in drain pan/water dam.	<ol style="list-style-type: none"> 1. Check T&P valve 2. Check all water fittings. 3. Pressurize and leak test tank.
Seven flashes and three second pause	Gas Control electronic fault detected.	<ol style="list-style-type: none"> 1. Control need to be reset. 2. Control is wet or physically damaged. 	<ol style="list-style-type: none"> 1. Reset Gas Control 2. Replace Gas Control.
Eight flashes and three second pause	Standing pilot remains on while set point knob is in "OFF" position.	Pilot valve stuck in open position.	Replace Gas Control.

SERVICE PROCEDURE RG-I
 Inner Door/Gasket Removal, Inspection
 Replacement and Reinstallation

Inner Door Removal Procedure

- Step 1. Rotate knob of the combination thermostat/gas valve to the "OFF" position.
- Step 2. Remove outer jacket burner access door
- Step 3. Inner Door Removal.

For Honeywell Control, rotate knob counter-clockwise to the "OFF" position.



For Robertshaw Control, rotate knob clockwise to the "OFF" position.



For White Rodgers Control, depress knob slightly and rotate clockwise to the "OFF" position.

- a) Disconnect resettable thermal switch wire leads (leading from Gas Control/gas valve).
- b) Remove (2) hex drive screws from right side inner door.
- c) Remove (2) hex drive screws from flange section of inner door.
- d) Remove (2) hex drive screws from left side inner door.
- e) Remove inner door and inspect per step 4.

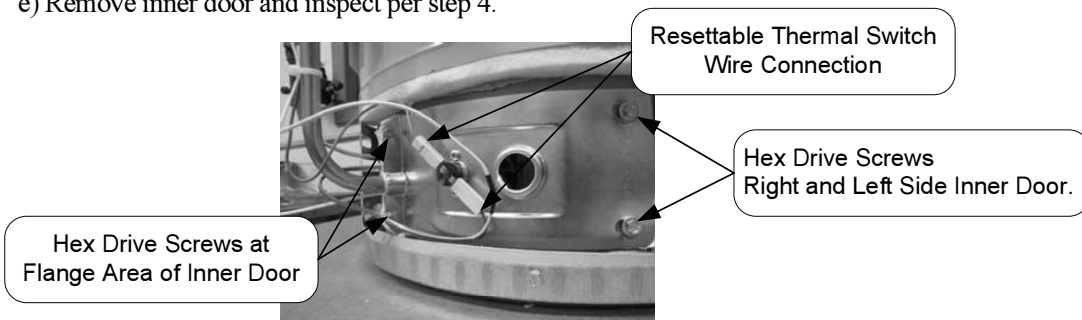

- Step 4. Fully inspect inner door gaskets for the following:
- >Tears
 - >Missing Material
 - >Cracks
 - >Dirt or debris
 - >Other imperfections that will inhibit proper seal
 - >Gasket adhesion to inner door
 - >Material left on combustion chamber (around opening)

If the gasket is not effected by any of the above, gasket replacement is not required. If replacement is required, proceed to **Inner Door Gasket Replacement Procedure.**

Inner Door Gasket Replacement Procedure.

⚠ WARNING
 If the information in these instructions is not followed exactly, a fire or explosion may result causing property damage, personal injury or death.

- Step 5. After inspection of inner door as noted in step 4, completely remove gasket and adhesive residue from right and left side inner doors as needed.
- Step 6. Use RTV sealant (recommended bead size 1/8") to secure the inner door gasket to the inner door sections (right & left). Refer to illustration on next page for proper application. Note the overlap configuration in the flange area of the inner door. Set the flange section first, this will help to achieve the proper over lap position.

SERVICE PROCEDURE RG-I
 Inner Door/Gasket Removal, Inspection
 Replacement and Reinstallation

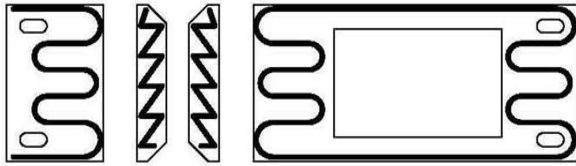

RECOMMENDED PATTERN
 FOR RTV SEALANT

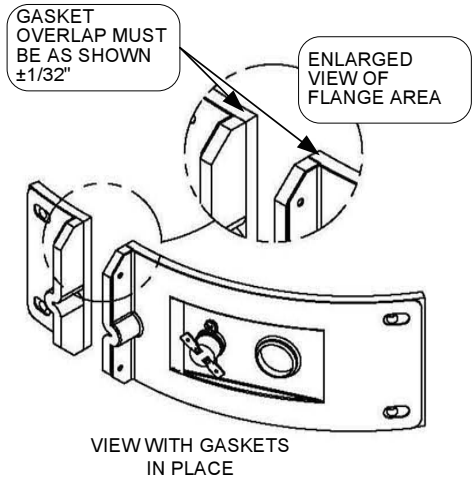
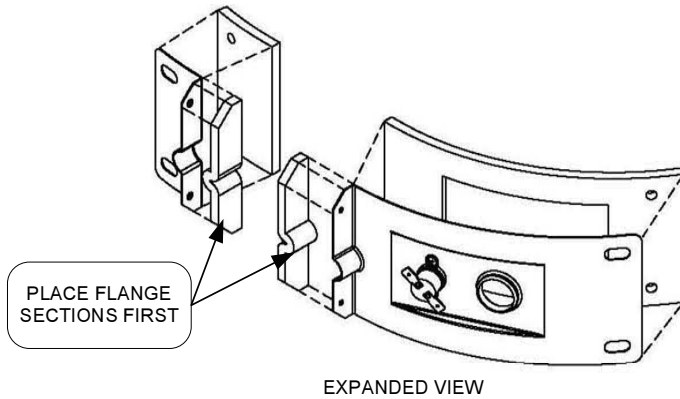

Installation of Inner Door With Gasket.

- Step 7. Clean any residual gasket residue or other debris from combustion chamber surface before installing the inner door/gasket assembly.
- Step 8. Place the left side inner door into position first. Firmly position the radiused channel of the inner door around the feedline. Using the (2) hex drive screws from step 3d, secure left side inner door in place. **DO NOT OVER TIGHTEN SCREWS.**
- Step 9. Position thermocouple, pilot tube and Piezo wire against left side inner door flange gasket. **DO NOT ROUTE THROUGH RADIUSED CHANNEL WITH FEEDLINE.**

⚠ WARNING
Stripped fastener connections may allow for seal breach of inner door. A seal breach may result in a fire or explosion causing property damage, personal injury or death. Do not over tighten screws in steps 8, 10 and 11.

If a fastener connection is stripped, contact the manufacturer listed on the water heater rating plate.

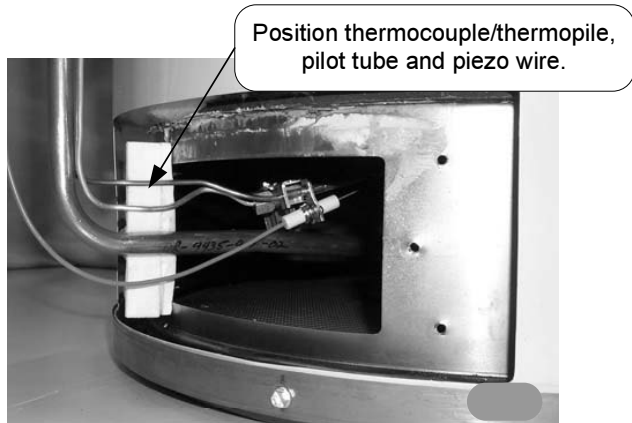

- Step 10. Firmly place right side inner door flange against the left side inner door flange and secure with (2) hex drive screws from step 3c. **DO NOT OVER TIGHTEN SCREWS.**
- Step 11. Align right side inner door to combustion chamber and verify the fastener holes of the combustion chamber are aligned with the right side inner door slotted opening. Verify seal integrity around combustion opening. Secure right side inner door using (2) hex drive screws from step 3b. **DO NOT OVER TIGHTEN SCREWS.** Verify both left and right sides of the inner door are properly positioned and sealed against the combustion chamber.

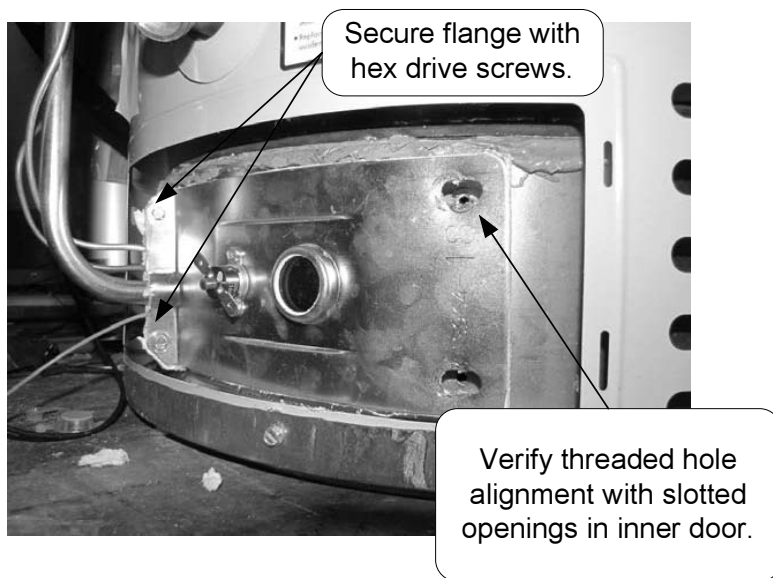

- Step 12. Reconnect lead wires from combination thermostat/gas valve to resettable thermal switch (See photo in step 3). Note, wire terminations are interchangeable with either resettable thermal switch connections.
- Step 13. Replace outer jacket burner access door.
- Step 14. To resume operation follow the instructions located on the lighting instruction label or the lighting instructions located in the installation and operation manual.

CLOSED CIRCUIT THERMOCOUPLE TESTING (White Rodgers Control)

- Step 1. Closed circuit testing is the preferred method for testing thermocouple. Following the lighting instruction label on the heater, proceed to light the pilot and allow to operate for three minuets. If the pilot will not stay lit, hold the pilot button (located on the combination thermostat/gas valve) down during this test
- Step 2. Using a multimeter capable of measuring millivolts, connect one lead using an alligator clip to the copper sheath of the thermocouple, use the second lead of the multi meter to probe the top terminal located at the back of the combination thermostat/gas valve.
- Step 3. If meter reads 10 millivolts or higher, the thermocouple is OK. If reading is below 10 millivolts, replace the thermocouple.

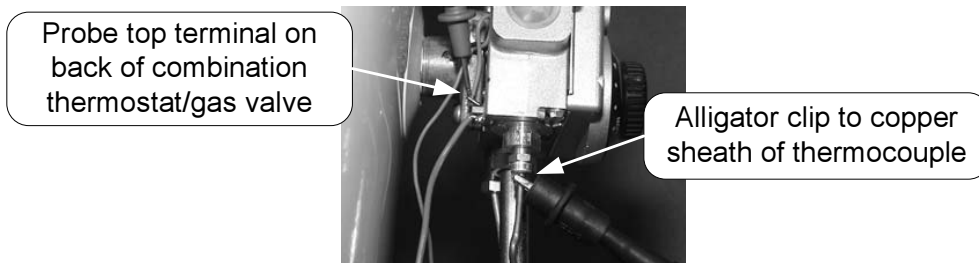

CLOSED CIRCUIT THERMOCOUPLE TESTING (Robertshaw Control)

- Step 1. Disconnect thermocouple from combination thermostat/gas valve.
- Step 2. Connect a thermocouple adaptor (BWC P/N 239-44642-00, Robertshaw P/N 75036) at the thermocouple location in the combination thermostat/gas valve.



- Step 3. Reconnect thermocouple to adaptor. Make certain all connections are tight (finger tight plus 1/4 turn)

- Step 4. Using a multimeter capable of measuring millivolts, connect one alligator clip to the set screw of the adaptor, and the other alligator clip to copper portion of the thermocouple.



- Step 5. Following the lighting instruction label on the heater, proceed to light the pilot and allow to operate for three minuets. If the pilot will not stay lit, hold the red reset button (located on the combination thermostat/gas valve) down during this test
- Step 6. If meter reads 13 millivolts or higher, the thermocouple is OK. If reading is below 13 millivolts replace the thermocouple.

OPEN CIRCUIT THERMOCOUPLE TESTING (White Rodgers/Robertshaw Gas Valve)

Step 1. Disconnect thermocouple from combination thermostat/gas valve.

Step 2. Using a multimeter capable of measuring millivolts, connect one alligator clip to the end ball or contact portion of the thermocouple, and the other alligator clip to copper portion of the thermocouple.



Step 3. Following the lighting instruction label on the heater, proceed to light the pilot and allow to operate for three minutes. **It will be necessary to hold the pilot button down continuously throughout this test.** A reading of 20 to 30 millivolts indicates good thermocouple output.

THERMOCOUPLE REPLACEMENT (White Rodgers/Robertshaw Gas Valve)

Step 1. Turn off gas supply to water heater. Rotate knob of combination thermostat/gas valve to “OFF” position.

For White Rodgers Control, depress knob slightly and rotate clockwise to the “OFF” position.



For Robertshaw Control, rotate knob clockwise to the “OFF” position.



Step 2. Remove outer jacket door.

Step 3. Remove right side of inner door per SERVICE PROCEDURE RG-I, steps 3a through 3c.

Step 4. Disconnect thermocouple from combination thermostat/gas valve. Locate other end of thermocouple inside of combustion chamber and remove from pilot bracket. Pull firmly pulling away from the pilot assembly.

Step 5. Install new thermocouple into pilot bracket making certain the thermocouple is fully engaged into the pilot bracket. Position thermocouple against left side inner door flange at its original position. Connect other end of thermocouple to combination thermostat/gas valve (finger tight + ¼ turn).

Step 6. Inspect inner door gasket per SERVICE PROCEDURE RG-I, Step 4.

Step 7. Install right side inner door per SERVICE PROCEDURE RG-I, Step 10 through Step 13

Step 8. To resume operation follow the instructions located on the lighting instruction label or the lighting instructions located in the installation and operation manual.

Thermocouple position

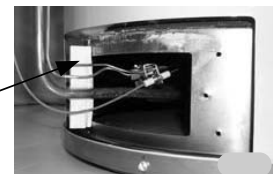

OPEN CIRCUIT THERMOPILE TESTING (Honeywell Gas Control)

The following test should be performed while the pilot flame is on.

- Step 1. Turn knob to pilot position and depress.
- Step 2. Continue pressing knob and remove red (+) wire from resettable thermal door switch.
- Step 3. Using a multimeter capable of measuring millivolts, connect the positive side of the multimeter to the terminal of the resettable thermal door switch. Connect the negative side of the multimeter to any earth ground location (jacket base, screw, etc.).

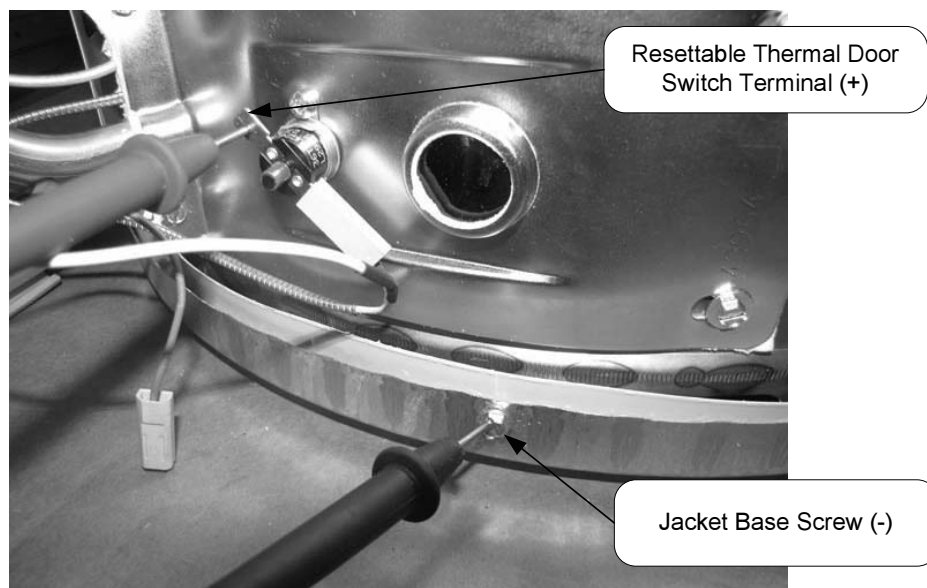

Normal thermopile operation will be between 350mV - 850mV. If reading is less than 350mV, replacement of pilot assembly is recommended following SERVICE PROCEDURE RG-III.

- Step 4. If thermopile reading is between 350mV - 850mV, remove multimeter and reconnect red wire to positive (+) terminal of Gas Control.
- Step 5. Release Gas Control knob and turn to desired setting to resume normal operation.

SERVICE PROCEDURE RG-III
Pilot Assembly Inspection, Cleaning
and Replacement

PILOT/ELECTRODE ASSEMBLY INSPECTION,
CLEANING AND REPLACEMENT

- Step 1. Turn off gas supply to water heater. Rotate knob of gas control/gas valve to "OFF" position.
- Step 2. Remove outer jacket door.
- Step 3. Remove right side of inner door per SERVICE PROCEDURE RG-I, steps 3a through 3c.
- Step 4. Disconnect thermocouple/thermopile, pilot tube, and feedline from gas control/gas valve.

NOTE: Feedline nut for natural gas control uses right hand threads, LP control uses left hand thread.

- Step 5. Disconnect piezo ignition wire from piezo igniter.
- Step 6. Remove burner assembly from combustion chamber.
- Step 7. Remove pilot/electrode assembly from feedline
- Step 8. Inspect pilot for the following:

- a) Primary air openings for blockage. Must be free from any debris (dirt, lint, etc).
- b) Kinks or cracks in the pilot tube. If found, the pilot must be replaced.

- Step 9. Inspect pilot orifice:

- a) Remove ½" nut from bottom of pilot assembly.
- b) Remove pilot tube and pilot orifice.
- c) Inspect pilot orifice for blockage, must be cleaned or replaced. (Honeywell pilot orifice not replaceable, replace pilot assembly)

- Step 10. Install pilot/electrode assembly to feedline, secure with screw from step 7.
- Step 11. Re-Install burner assembly into combustion chamber, connect feedline, pilot tube and thermocouple/thermopile to gas control/gas valve.
- Step 12. Install inner door per SERVICE PROCEDURE RG-I, step 4 through 13.
- Step 13. To resume operation follow the instructions located on the lighting instruction label or the lighting instructions located in the installation and operation manual.

For Honeywell Control, rotate knob counter-clockwise to the "OFF" position.



For White Rodgers Control, depress knob slightly and rotate clockwise to the "OFF" position.



For Robertshaw Control, rotate knob clockwise to the "OFF" position.

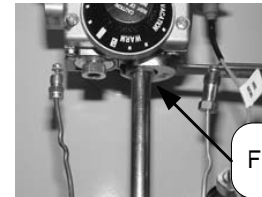

Feedline Nut

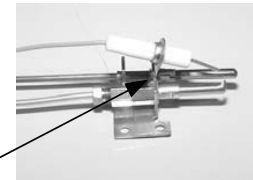

Primary Air Opening

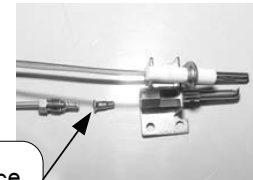

Pilot Orifice

Removal of thermopile from Honeywell pilot assembly is not recommended, but can be achieved by viewing the pilot assembly from the top and pressing the thermopile towards the right while pulling to remove.

PIEZO IGNITER, ELECTRODE TESTING AND REPLACEMENT

With the pilot not in operation (no pilot flame) you can check the Piezo and electrode circuit by viewing pilot thru the sight glass located on the inner door and observing the spark action.

- Step 1. Remove outer jacket door.
- Step 2. Repeatedly depress the Piezo igniter while viewing the pilot thru the sight glass. If a spark is present, the circuit is OK. If there is no spark, proceed to step 3.

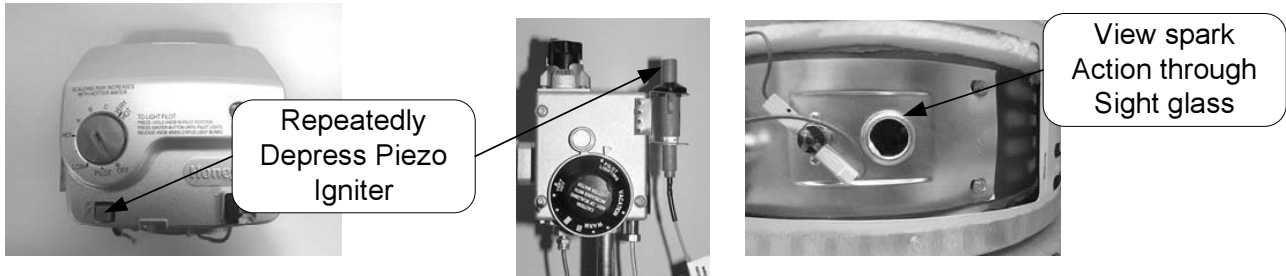

- Step 3 Remove orange (or white) wire from Piezo igniter and install a jumper wire in its place. Hold the other end of the jumper by the wire insulation or using an insulated tool, next to an unpainted surface such as the feedline or gas valve and depress the Piezo igniter. If there is a spark, the igniter is OK, the pilot is not functioning and must be replaced, see SERVICE PROCEDURE RG-III for pilot replacement. If no spark is present the igniter is not functioning and must be replaced.



- Step 4a. **For White Rodgers/Robertshaw gas valves:** With orange wire disconnected from piezo igniter. Using a common screw driver, place blade of screw driver under piezo bracket and gently pry bracket from front of gas valve and unhook bracket from rear of gas valve.

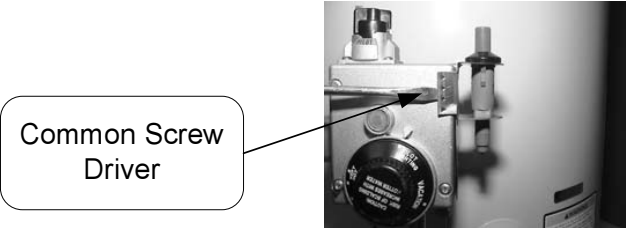

- Step 4b. **For Honeywell gas controls:** To replace igniter, see “Gas Control Disassembly/Reassembly” in SERVICE PROCEDURE RG-VI.

Gas Valve Testing and Replacement (White Rodgers/Robertshaw)

The gas valve is a non-repairable device. If trouble shooting has determined a problem with the gas valve, it must be replaced.

If the burner and/or pilot do not function, service checks for gas pressure, thermocouple output, magnet assembly and ECO are to be performed. If these check OK, the gas valve may be faulty.

LINE PRESSURE

The gas valve is designed for a maximum line pressure of 14.0" w.c. and a minimum line pressure of 1.0" w.c. over the water heater rated manifold pressure (check rating plate). Line pressure must be checked with burner on and burner off to assure proper readings.

MANIFOLD PRESSURE TESTING (this procedure assumes a maximum line pressure of 14.0" w.c.)

- Step 1. Set gas valve to "OFF" position.
- Step 2. Remove pressure tap plug and install pressure tap.
- Step 3. Connect manometer to pressure tap.
- Step 4. Follow lighting instructions and proceed to light main burner and observe manometer reading.
- Step 5. Proper operating range for natural gas is 4.0 ± 0.3" W.C.
 Proper operating range for L.P. gas is 10.0 ± 0.5" W.C.
- Step 6. If pressure is OK, set gas valve to "OFF" remove manometer and pressure tap and replace pressure tap plug. Check for gas leaks before placing water heater back in operation. If pressure is out of the specification noted in step 5, proceed to step 7 or 8 for proper service procedure.
- Step 7. For White Rodgers control, the manifold pressure is not adjustable. If manifold pressure is outside the range in step 5, the control must be replaced.
- Step 8. For Robertshaw control, the manifold pressure is adjustable, proceed to step 9 for adjustment procedure
- Step 9. While burner is in operation, remove regulator access cap to expose the regulator adjusting screw. With small screw driver, rotate adjusting screw clockwise to increase pressure and counter clockwise to decrease pressure.



Pressure Tap
Shown Installed



- Step 10. Replace regulator access cap, set gas valve to "OFF". Remove manometer and pressure tap and replace pressure tap plug. Check for gas leaks before placing water heater back in operation.

THERMOCOUPLE TESTING

See SERVICE PROCEDURE RG-II

MAGNET ASSEMBLY TESTING (White Rodgers Control)

- Step 1. Following the lighting instruction label on the heater, proceed to light the pilot and allow to operate for three minutes. If the pilot will not stay lit, hold the pilot button (located on the gas valve) down during this test.
- Step 2. Using a multimeter capable of measuring millivolts, connect one lead using an alligator clip to the copper sheath of the thermocouple, use the second lead of the multi meter to probe the top terminal located at the back of the gas valve.

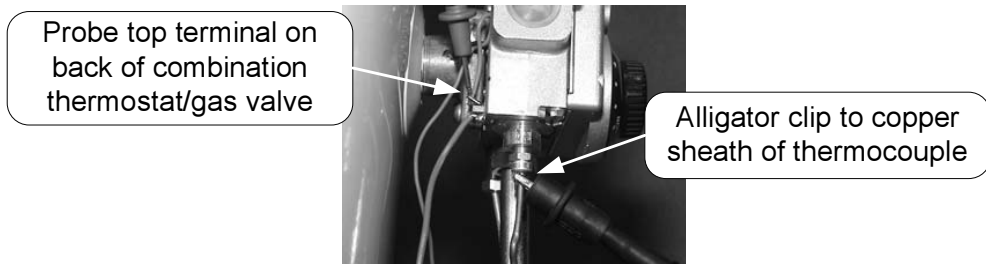

- Step 6. With a meter reading of 13 millivolts or greater, rotate knob of combination thermostat/gas valve to the “OFF” position.
- Step 7. The magnet should remain closed for a drop of at least 6 millivolts. You will here a “snap” or “click” sound when the magnet opens, if you hear this sound prior to a drop of 6 millivolts, the magnet is out of specification and the gas valve should be replaced.

MAGNET ASSEMBLY TESTING (Robertshaw Control)

- Step 1. Disconnect thermocouple from gas valve.
- Step 2. Connect a thermocouple adaptor (BWC P/N 239-44642-00, Robertshaw P/N 75036) at the thermocouple location in the gas valve.
- Step 3. Reconnect thermocouple to adaptor. Make certain all connections are tight (finger tight plus 1/4 turn).
- Step 4. Using a multimeter capable of measuring millivolts, connect one alligator clip to the set screw of the adaptor and the other alligator clip to copper portion of the thermocouple.
- Step 5. Following the lighting instruction label on the heater, proceed to light the pilot and allow to operate for three minutes.
- Step 6. With a meter reading of 13 millivolts or greater, rotate knob of gas valve to the “OFF” position.
- Step 7. The magnet should remain closed for a drop of at least 6 millivolts. You will here a “snap” or “click” sound when the magnet opens, if you hear this sound prior to a drop of 6 millivolts, the magnet is out of specification and the gas valve should be replaced.

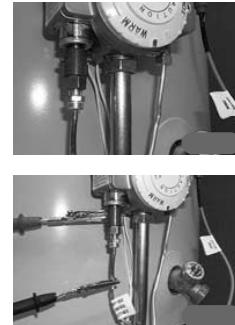

ECO (Energy Cut Off) TESTING

- Step 1. Disconnect thermocouple from gas valve.
- Step 2. Using a multimeter capable of measuring Ohms (or continuity), attach one lead (alligator clip) to the pilot tube. Insert the other lead (probe) fully into the magnet opening. Be sure the probe makes contact only at the top center of the magnet opening. Do not allow the probe to make contact with the threaded sides of the opening.
- Step 3. If continuity is indicated, the ECO is OK. If continuity is not indicated, the ECO has opened and the gas valve must be replaced.



COMBINATION THERMOSTAT/GAS VALVE REPLACEMENT

- Step 1. Rotate knob of the gas valve to the “OFF” position.
- Step 2. Turn off gas supply to water heater.
- Step 3. Disconnect gas supply line from gas valve.
- Step 4. Turn off water supply and drain water heater completely.
- Step 5. Remove outer jacket burner access door.
- Step 6. Right side inner door removal.

For White Rodgers Control, depress knob slightly and rotate clockwise to the “OFF” position.



For Robertshaw Control, rotate knob clockwise to the “OFF” position.



- a) Disconnect resettable thermal switch wire leads (leading from gas valve) and remove wire tie from feedline.
- b) Remove (2) hex drive screws from right side inner door.
- c) Remove (2) hex drive screws from flange section of inner door.
- d) Remove right side inner door and set aside. Be careful not to damage gasket material on inner door.

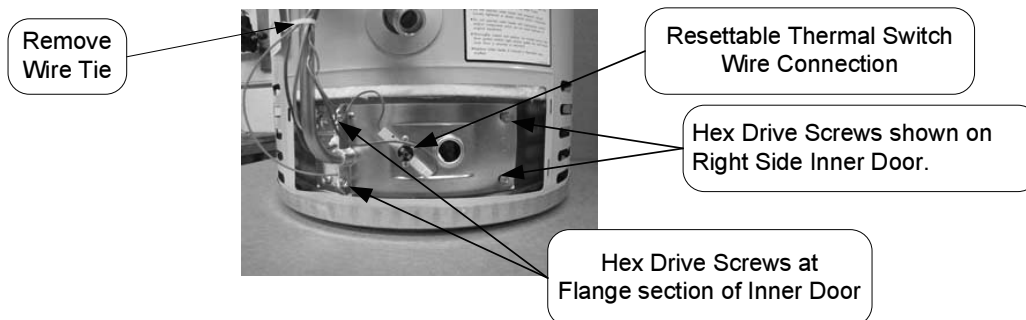

Step 7. Removal of gas valve.

- a) Disconnect main burner feedline, pilot tube and thermocouple from gas valve & remove burner from combustion chamber.

NOTE: Feed line nut for natural gas control uses right hand threads, LP control uses left hand thread.

- b) Remove piezo bracket with piezo igniter (refer to SERVICE PROCEDURE RG-IV) from gas valve.
- c) Remove gas valve from water heater, rotating counter clockwise using a control body wrench or a length of ½" NPT pipe threaded into inlet of control.

To remove or install control, insert only ½" NPT threaded pipe into inlet and use to loosen or tighten control.

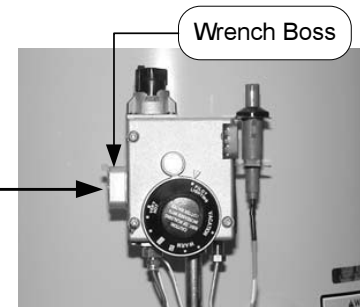

Step 8. Installation of gas valve.

- a) Install new gas valve using a control body wrench or a length of ½" NPT pipe threaded into inlet of control. **DO NOT OVER TIGHTEN.** Use caution not to damage cast aluminum body of gas valve. Be certain not to damage the bundled wire leads.

Note: Gas valve must be installed in proper upright position to assure the feedline will align properly at the inner door flange. **DO NOT OVER TIGHTEN.** If control is turned past proper alignment, do not reverse direction to align.

- b) Reattach Piezo bracket with Piezo igniter to gas valve.
- c) Reattach main burner feedline, pilot tube and thermocouple to gas valve.

NOTE: Feedline nut for natural gas control uses right hand threads, LP control uses left hand thread.

- d) Gather wire leads of gas valve and Piezo igniter and secure along side of feedline using new wire tie provided.
- e) Connect gas supply piping to inlet of control. Use back up wrench on wrench boss of control, never use back up wrench on body of control.

Step 9. Reinstallation of inner door assembly.

- a) Prior to reinstallation of inner door, fully inspect inner door gasket for the following:
- > Tears
 - > Missing Material
 - > Cracks
 - > Dirt or debris
 - > Gasket Adhesion to inner door
 - > Other imperfections that will inhibit proper seal
 - > Material left on combustion chamber

If the gasket is not effected by any of the above, gasket replacement will not be required. If replacement is required, replace using new gasket kit following the instructions provided with kit.

Step 9. Reinstallation of inner door assembly. (cont.)

- b) Clean any gasket residue or other debris from combustion chamber surface before installing the inner door/gasket assembly.
- c) Position thermocouple, pilot tube and Piezo wire against left side inner door flange gasket. **DO NOT ROUTE THROUGH RADIUSED CHANNEL WITH FEEDLINE.** Be sure that thermocouple and pilot tube are not in position to interfere with outer jacket burner access door when reinstalled.

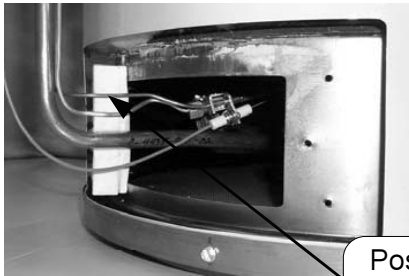

Position thermocouple, pilot tube and Piezo wire.

▲ WARNING
 A seal breach may result in a fire or explosion causing property damage, personal injury or death.

- d) Firmly place right side inner door flange against the left side inner door flange and secure with (2) hex drive screws from step 6c. **DO NOT OVER TIGHTEN SCREWS.**
- e) Align right side inner door to combustion chamber and verify the fastener holes of the combustion chamber are aligned with the right side inner door slotted openings. Verify seal integrity around combustion opening. Secure right side inner door using (2) hex drive screws from step 6b. **DO NOT OVER TIGHTEN SCREWS.** Verify both left and right sides of the inner door are properly positioned and sealed against the combustion chamber.

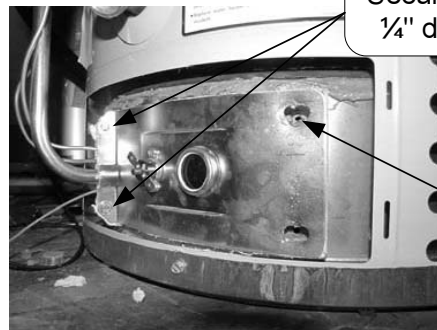

Secure flange with 1/4" drive screws.

Verify threaded hole alignment with slotted openings in inner door.

- Step 10. Reconnect wire leads from gas valve to resettable thermal switch (See photo in step 6). Note: wire terminations are interchangeable with either resettable thermal switch connection.
- Step 11. Replace outer jacket burner access door.
- Step 12. Reconnect gas supply to gas valve.
- Step 13. Resume water supply to water heater. Be sure tank is full of water.
- Step 14. To resume operation follow the instructions located on the lighting instruction label or the lighting instructions located in the installation and operation manual.

Honeywell Gas Control Testing, Disassembly, and Replacement

The Gas Control is made up of (5) major components; the control cover, the piezo igniter, the valve body, the temperature sensor, and the back plate. The Gas Control is designed so that any of these components may be replaced without replacing the entire Gas Control.

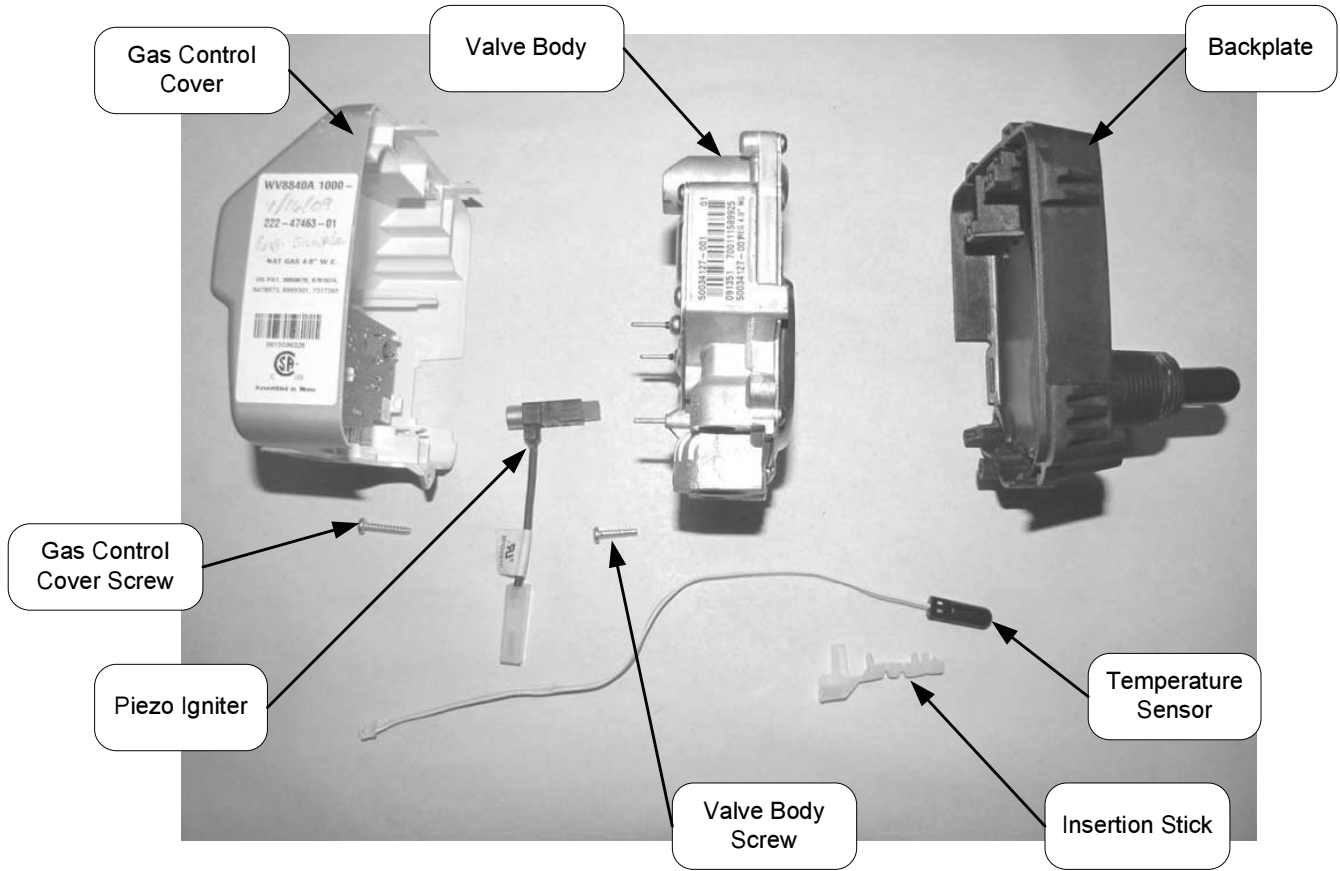

LINE PRESSURE

The Gas Control is designed for a maximum line pressure of 14.0" w.c. and a minimum line pressure of 1.0" w.c. over the water heater's rated manifold pressure (check rating plate). Line pressure must be checked with the main burner on and off to assure proper readings.

MANIFOLD PRESSURE TESTING (this procedure presumes a maximum line pressure of 14.0" w.c.)

- Step 1. Set the Gas Control to the "OFF" position.
- Step 2. Remove pressure tap plug and install 1/8" NPT pipe, coupling, & pressure tap.
- Step 3. Connect manometer to pressure tap.
- Step 4. Follow instructions located on the lighting instructions label and proceed to light the main burner and observe manometer reading.
- Step 5. Proper operating range for natural gas is: 4.0" ±0.5" w.c.
 Proper operating range for LP gas is: 10.0" ±0.5" w.c.
- Step 6. If pressure is within the range specified in the previous step, set Gas Control knob to the "OFF" position, remove manometer and pressure tap, and replace pressure tap plug. Check for gas leaks prior to placing water heater back into operation by following the instructions located on the lighting instruction label or the lighting instructions located in the installation and operation manual.
- Step 7. If gas pressure is outside the specification noted above, refer to "Honeywell Gas Control Testing, Disassembly, and Replacement" to replace Gas Control or valve body.



Gas Control shown in the "OFF" position

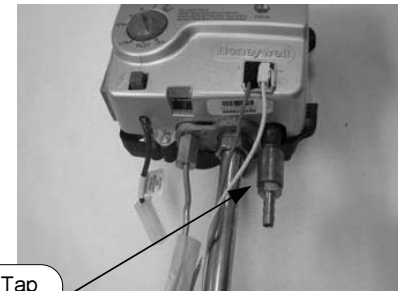

Pressure Tap
 Shown Installed

THERMOPILE TESTING

See SERVICE PROCEDURE RG-II

ECO (Energy Cut Off) TESTING

The Honeywell Gas Control is designed with an ECO device that will reset.

To reset the Gas Control after an error code (4), turn the Gas Control knob to the "OFF" position and wait a minimum of (5) minutes before relighting following the instructions located on the lighting instruction label or the lighting instructions located in the installation and operation manual.

TEMPERATURE SENSOR TESTING

If Control has gone into lockout due to excessive tank temperature (four flash, three second pause) reset control by rotating gas control knob to "OFF" position and wait a minimum of (5) minutes. Then follow lighting instructions and return gas control knob to desired setpoint.

Observe Green LED indicator. Does error code 4 (four flash, three second pause) continue?

Y
Temperature Sensor Testing
 Following "Gas Control Disassembly/Reassembly" instructions, disassemble Gas Control to access temperature sensor.

With the temperature sensor still in the back plate, use a multi-meter set to the Ohms setting, determine the resistance of temperature sensor (see caution and photos above)

Once the temperature sensor resistance values are known, the water temperature must also be known to determine if the resistance values are correct. See next page to obtain water temperature.
 Are temperature sensor resistance values correct?

Y
 Replace Gas Control

N
 Resume normal operation.

CAUTION
 DO NOT use standard multimeter probes for this test. Doing so will damage connector. Use special pin type electronic probes or small diameter wire pins inserted into connector.



Using a multi-meter set to the ohms setting, insert one meter probe (see caution) into center wire position of thermal well connector, insert the second probe (see caution) into either of the outside wire positions (see photo on left).

Alternate the probe on the outside position to the opposite outside wire position (see photo on right).

▲ WARNING
 Stored water may be **HOT** when performing the following steps in this procedure.
 Take necessary precaution to prevent personal injury.

DETERMINE WATER TEMPERATURE INSIDE TANK

Note: It is important to understand once the resistance for the temperature sensor is determined from the previous page, water flow through the water heater should not occur. Prior to drawing water from drain valve, turn off the cold water supply to the water heater. This will prevent cold water flow into the tank affecting the resistance value of the temperature sensor.

- Step 1. Set the Gas Control knob to the “OFF” position.
- Step 2. Turn off inlet water supply to water heater.
- Step 3. Draw approximately 4 gallons of water from drain valve into a container, or suitable drain, and discard. Draw an additional gallon and immediately measure water temperature using an accurate thermometer. It may be necessary to open a hot water faucet to allow water heater to drain.
- Step 4. Using the chart below, determine correct resistance value for the water temperature from step 3.

Example: If temperature of water is 84°F, then the resistance through the sensor would be 8449 (see shaded area). NOTE: Sensor resistance increases as the temperature decreases.

Sensor Resistance at Various Temperatures

In Degrees F										
°F	0	1	2	3	4	5	6	7	8	9
40	26109	25400	24712	24045	23399	22771	22163	21573	21000	20445
50	19906	19383	18876	18383	17905	17440	16990	16553	16128	15715
60	15314	14925	14548	14180	13823	13477	13140	12812	12494	12185
70	11884	11592	11308	11032	10763	10502	10248	10000	9760	9526
80	9299	9078	8862	8653	8449	8250	8057	7869	7685	7507
90	7333	7165	7000	6839	6683	6531	6383	6238	6098	5961
100	5827	5697	5570	5446	5326	5208	5094	4982	4873	4767
110	4663	4562	4464	4368	4274	4183	4094	4006	3922	3839
120	3758	3679	3602	3527	3453	3382	3312	3244	3177	3112
130	3048	2986	2925	2866	2808	2752	2697	2643	2590	2538
140	2488	2439	2391	2344	2298	2253	2209	2166	2124	2083
150	2043	2004	1966	1928	1891	1856	1820	1786	1753	1720
160	1688	1656	1625	1595	1566	1537	1509	1481	1454	1427
170	1402	1376	1351	1327	1303	1280	1257	1235	1213	1191
180	1170	1150	1129	1110	1090	1071	1953	1035	1017	999
190	982	965	949	933	917	901	886	871	857	842
200	828	814	801	788	775	762	749	737	725	713

GAS CONTROL DISASSEMBLY/REASSEMBLY

- Step 1. Rotate knob of the Gas Control to the “OFF” position.
- Step 2. Turn off gas supply to water heater.
- Step 3. Disconnect gas supply line from Gas Control.
- Step 4. Disconnect piezo igniter wire.
- Step 5. Remove inner door assembly following SERVICE PROCEDURE RG-I, steps 1 through 3c.
- Step 6. Remove Gas Control cover screw.



Rotate knob counter-clockwise to the “OFF” position.



Gas Control cover screw

- Step 7. Depress both tabs on the top of the Gas Control cover and pull to remove.



CAUTION
 Use caution not to bend or damage valve body pins when removing or installing Gas Control cover.

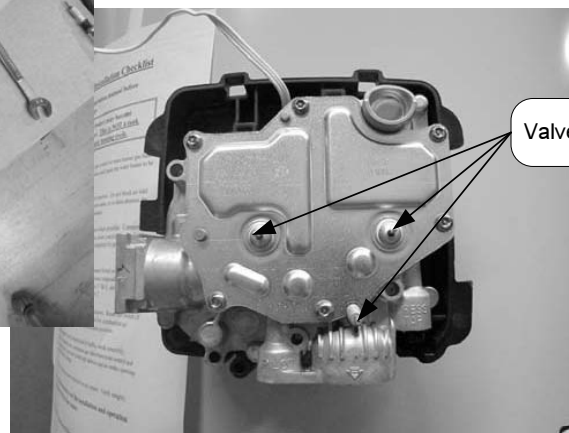

Valve body pins

GAS CONTROL DISASSEMBLY/REASSEMBLY

Step 8. Disconnect temperature sensor from control board and remove wire from the temperature sensor wire routing clip.

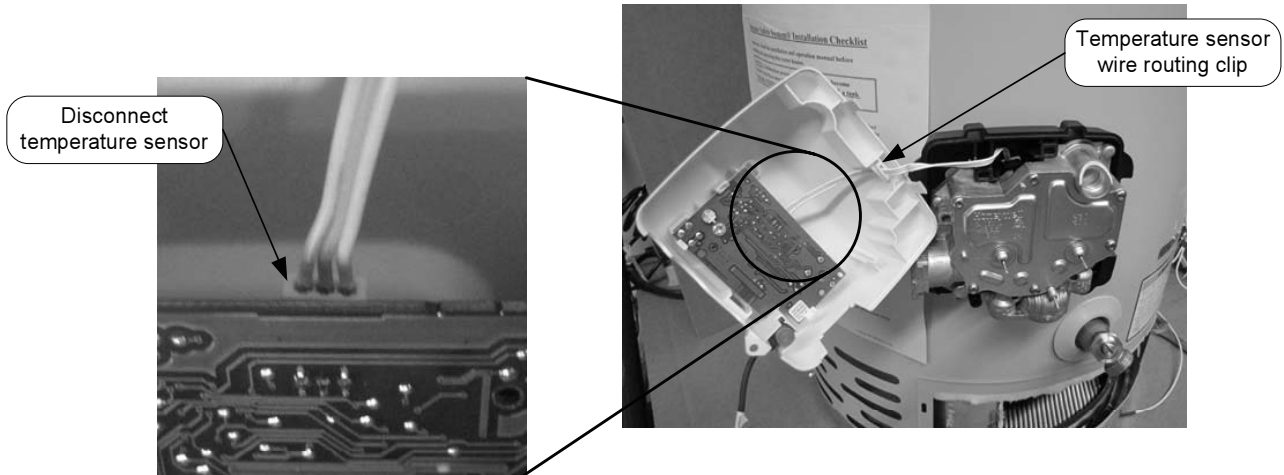

Step 9. Remove the piezo igniter from the control cover by releasing the lock tab on the control cover.

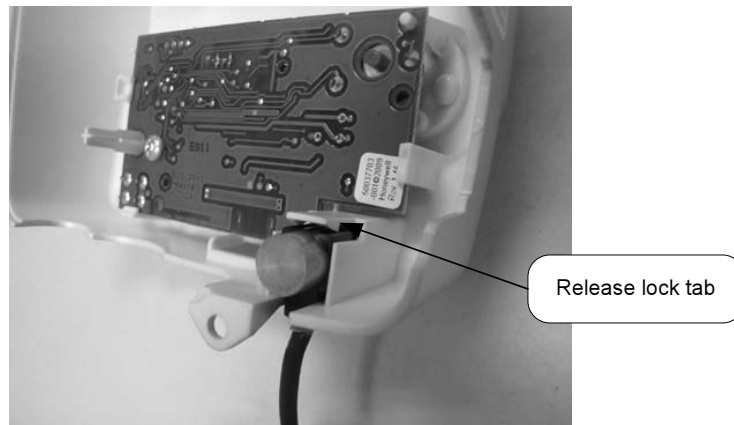

GAS CONTROL DISASSEMBLY/REASSEMBLY

Step 10. Remove the valve body by removing screw located at the lower left corner then unclipping the lower right side from the backplate first followed by the lower left side using a flat head screwdriver.

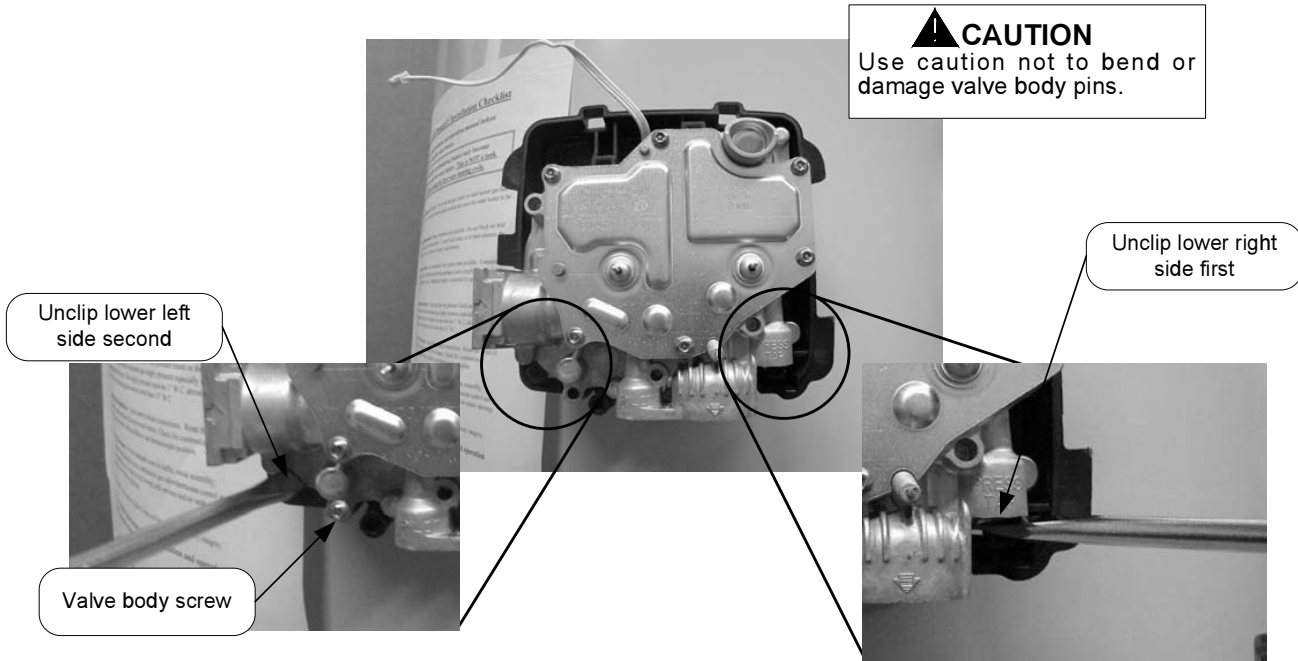

Step 11. Remove temperature sensor and insertion stick from backplate by first removing wire from the temperature sensor wire routing clips located on the backplate. Note the orientation of insertion stick, insertion stick can only be installed in one way.

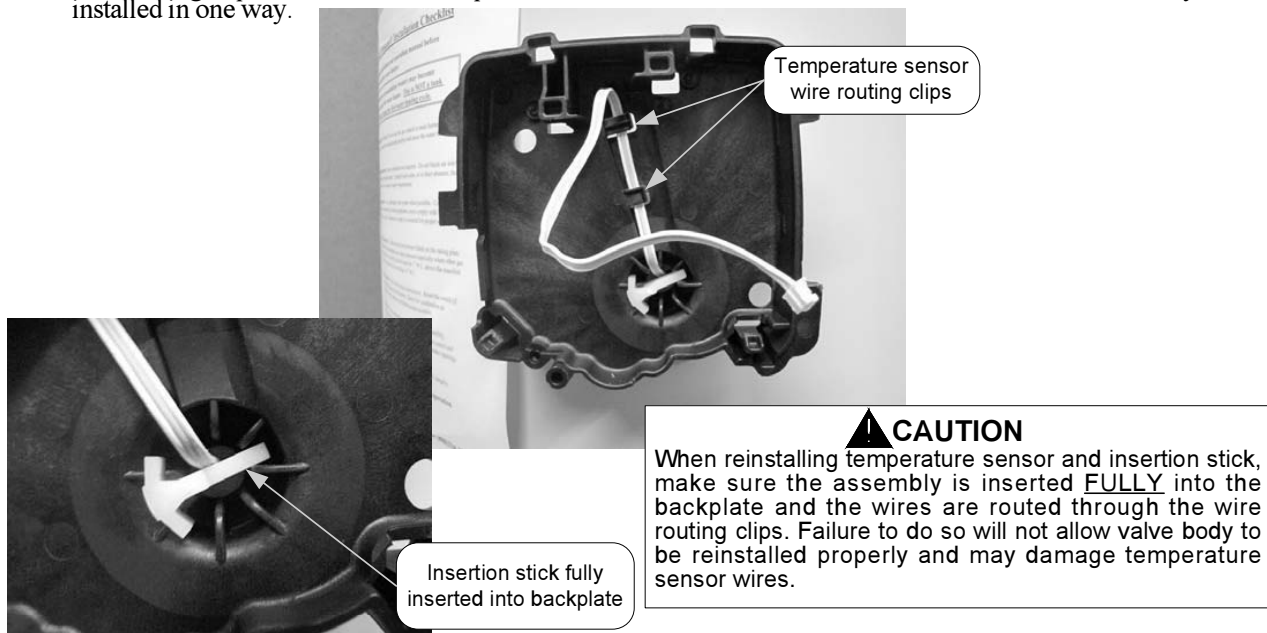

GAS CONTROL DISASSEMBLY/REASSEMBLY

Step 12. Remove temperature sensor from insertion stick by pulling apart as illustrated below.

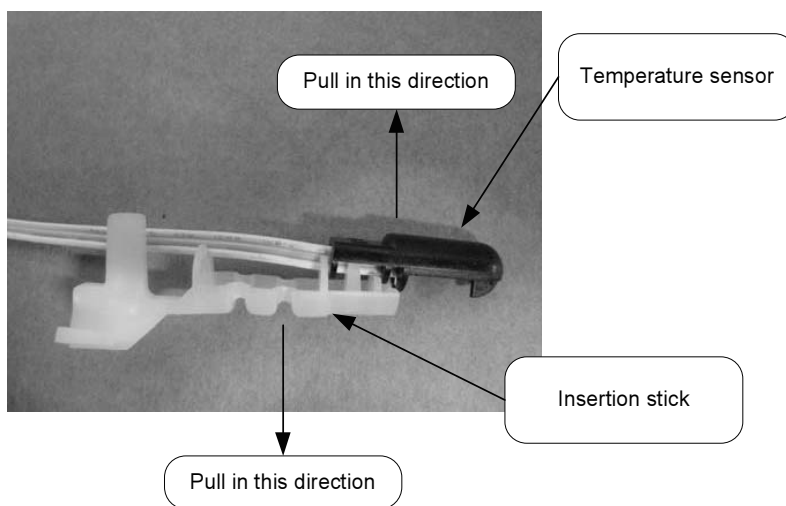

Step 13. To reassemble Gas Control, follow the previous steps in reverse order. Once Gas Control is reassembled, burner assembly is reinstalled, and the gas supply line is reconnected, resume water supply to water heater. Be sure tank is full of water before relighting.

Step 14. To resume operation, follow the instructions located on the lighting instruction label or the lighting instructions located in the installation and operation manual.

GAS CONTROL REPLACEMENT

- Step 1. Rotate knob of the Gas Control to the “OFF” position.
 Step 2. Turn off gas supply to water heater.
 Step 3. Disconnect gas supply line from Gas Control.
 Step 4. Turn off water supply and drain water heater completely.
 Step 5. Remove outer jacket burner access door.

Rotate knob counter-clockwise to the “OFF” position.



Step 6. Right side inner door removal.

- a) Disconnect red wire leads from resettable thermal switch.
- b) Remove (2) hex drive screws from RIGHT side inner door.
- c) Remove (2) hex drive screws from FLANGE SECTION of inner door.
- d) Remove right side inner door and set aside. Be careful not to damage gasket material on inner door.

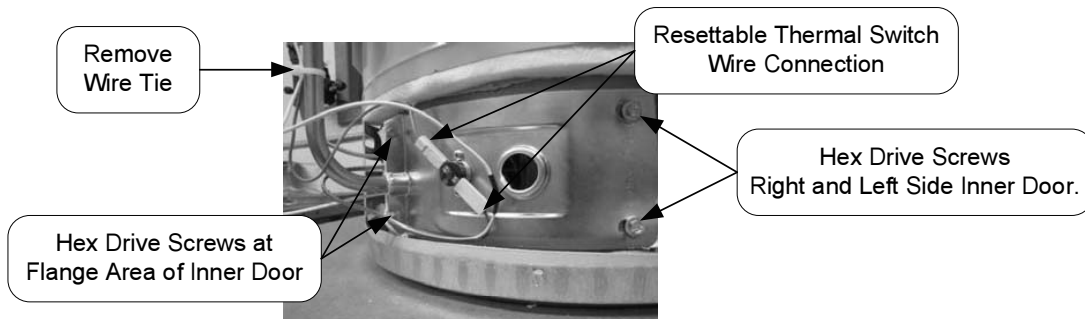

Step 7. Removal of Gas Control.

- a) Disconnect main burner feedline, pilot tube, piezo igniter wire, inner door wire (red) and thermopile wire (white) from Gas Control.
- b) Remove Gas Control from water heater by rotating counter clockwise. DO NOT use a wrench on the Gas Control body, damage to the Gas Control may occur. If necessary, use a length of ½" NPT pipe threaded into gas inlet of Gas Control.

Step 8. Install new Gas Control into water heater.

- a) Install new Gas Control into water heater by rotating clockwise. DO NOT use a wrench on the Gas Control body, damage to the Gas Control may occur. If necessary, use a length of ½" NPT pipe threaded into gas inlet of Gas Control.

GAS CONTROL REPLACEMENT

Step 8. Install new Gas Control into water heater (contintued).

- b) Reattach main burner feedline, pilot tube, piezo igniter wire, inner door wire (red) and thermopile wire (white) to Gas Control. Attach inner door wire (red) to the positive (+) terminal and the thermopile wire (white) to the negative (-) terminal.

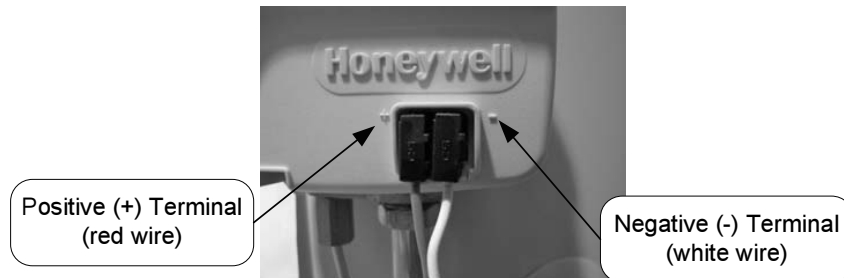

- c) Gather piezo igniter wire, thermopile wire (white), inner door wire (red), and pilot tube and secure along side of feedline using new wire tie provided.
- d) Reconnect gas supply piping to inlet of Gas Control.

CAUTION
 Use back up wrench on wrench boss of Gas Control, never use back up wrench on body of Gas Control.

Step 9. Reinstallation of inner door assembly.

- a) Prior to reinstallation of inner door, fully inspect inner door gasket for the following:

- > Tears
- > Missing Material
- > Cracks
- > Dirt or debris
- > Gasket Adhesion to inner door
- > Other imperfections that will inhibit proper seal
- > Material left on combustion chamber

If the gasket is not effected by any of the above, gasket replacement will not be required. If replacement is required, replace using new gasket kit following the instructions provided with kit.

- b) Clean any gasket residue or other debris from combustion chamber surface before installing the inner door/gasket assembly.
- c) Position thermopile wire, pilot tube and Piezo wire against left side inner door flange gasket. **DO NOT ROUTE THROUGH RADIUSED CHANNEL WITH FEEDLINE.** Be sure that thermopile and pilot tube are not in position to interfere with outer jacket burner access door when reinstalled.

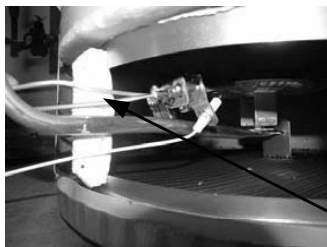

Position thermopile, pilot tube and Piezo wire.

WARNING
 A seal breach may result in a fire or explosion causing property damage, personal injury or death.

GAS CONTROL REPLACEMENT

Step 9. Reinstallation of inner door assembly (continued).

- d) Firmly place right side inner door flange against the left side inner door flange and secure with (2) hex drive screws from step 6c. **DO NOT OVER TIGHTEN SCREWS.**
- e) Align right side inner door to combustion chamber and verify the fastener holes of the combustion chamber are aligned with the right side inner door slotted openings. Verify seal integrity around combustion opening. Secure right side inner door using (2) hex drive screws from step 6b. **DO NOT OVER TIGHTEN SCREWS.** Verify both left and right sides of the inner door are properly positioned and sealed against the combustion chamber.

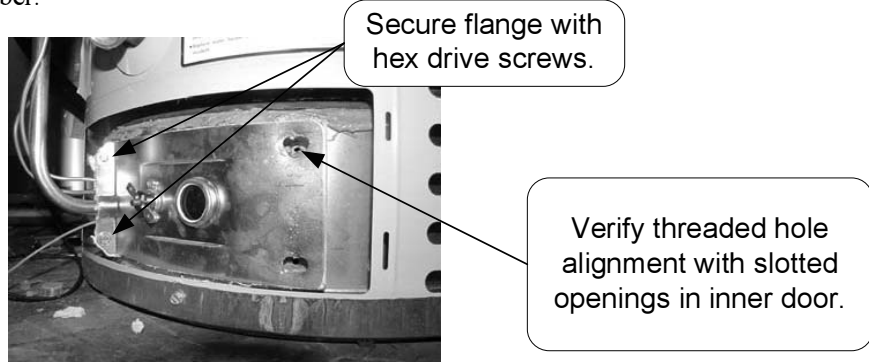

Step 10. Reconnect (2) red wire leads from pilot assembly and Gas Control to resettable thermal switch. Note: wire terminations are interchangeable with either resettable thermal switch connection.

Step 11. Replace outer jacket burner access door.

Step 12. Reconnect gas supply to Gas Control.

CAUTION
 Use back up wrench on wrench boss of Gas Control, never use back up wrench on body of Gas Control.

Step 13. Resume water supply to water heater. Be sure tank is full of water before resuming operation.

Step 14. To resume operation follow the instructions located on the lighting instruction label or the lighting instructions located in the installation and operation manual.

**MAIN BURNER: Inspection, Adjustment,
 Cleaning and Replacement**

At periodic intervals (not more than 6 months) a visual inspection should be made of the main burner for proper operation and to insure no debris accumulating.

Main burner should light smoothly from pilot and burn with a blue flame with a minimum of yellow tips.

Steel burner models have a self adjusting air mixture and do not have an adjustable air shutter. Cast iron burner can have the gas and air mixture properly proportioned by adjusting the air shutter on the mixer face of the main burner (see step 2 below).

Main burner must be free from any debris accumulation that may effect burner operation (see burner cleaning procedure on page 17).

CAST IRON BURNER ADJUSTMENT

▲ DANGER

Under no circumstances shall flammable materials be used or stored in the vicinity of the water heater. With the inner door removed the Bradford White Defender Safety System will be inactivated. If flammable vapors are present, a fire or explosion may result causing property damage, personal injury or death.

Upon completion of the cast iron burner adjustment procedure, the inner door must be replaced per SERVICE PROCEDURE RG-1, steps 4 through 14 to reactivate Bradford White Defender Safety System.

▲ WARNING

Inner door and burner components may be HOT when performing this operation. Take necessary precaution to prevent personal injury.

- Step 1. With main burner in operation, remove right side inner door per SERVICE PROCEDURE I, steps 3b & 3c. Be sure to maintain wire connection to resettable thermal switch for this adjustment procedure.
- Step 2. To adjust for proper burning, loosen the air shutter nut, rotate the shutter to close the opening in the burner, then slowly rotate the shutter until the yellow tips disappear and the flame becomes blue. Tighten the air shutter nut. Too much air will cause the flame to lift off the burner ports and create noisy burner operation. Too little air (yellow tips) will result in soot formation.

Place right side inner door into proper position to confirm proper burner flame pattern and correct air shutter adjustment. It may be necessary to allow the burner to operate for several minutes for burner flame to stabilize.

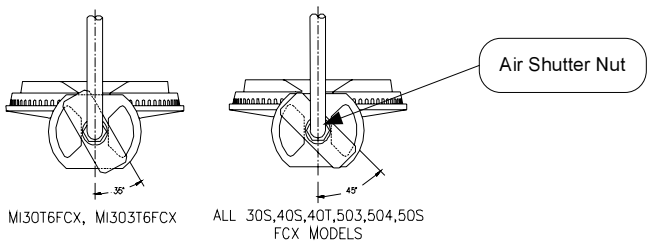

SERVICE PROCEDURE RG-VII
 Burner Operation Inspection, Adjustment
 Cleaning and Replacement

**MAIN BURNER: Inspection, Adjustment,
 Cleaning and Replacement (cont.)**

Step 3. Fully inspect inner gasket per SERVICE PROCEDURE RG-I, step 4. Replace gasket if required following SERVICE PROCEDURE I, steps 5 & 6.

Step 4. Be certain that thermocouple, pilot tube and piezo wire are routed by inner door flange as shown and Reinstall inner door per SERVICE PROCEDURE RG-I, step 10 and 11.

Position thermocouple/thermopile,
 pilot tube and Piezo wire.



Step 5. Observe burner operation through sight glass of inner door. Burner should operate as adjusted in step 2, if not, repeat procedure compensating air shutter position for proper burner operation with inner door in place.

Step 6. It may be necessary to clean main burner or main burner orifice to achieve proper burner operation. If cleaning is required proceed to burner cleaning section in this procedure.

BURNER CLEANING (Steel & Cast Iron)

Step 1. Remove inner door assembly per SERVICE PROCEDURE RG-I, steps 1 through 3c.

Step 2. Disconnect main burner feed line, pilot tube and thermocouple/thermopile from combination thermostat gas valve and remove burner assembly from combustion chamber.

NOTE: Feedline nut for natural gas control uses right hand threads,
 LP control uses left hand thread.

Step 3. Thoroughly inspect burner surface area and burner ports and remove any loose debris accumulation.



Burner Surface Area



Burner Port Area



Step 4. On cast iron burners, inspect for any debris build up inside burner venturi. If found, disconnect feedline from burner and remove debris build up.

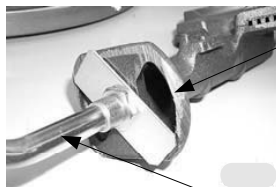

Burner Venturi
 Opening

Feedline

BURNER CLEANING (Cont.)

- Step 5. Disconnect (unscrew) Main burner (steel) from main burner orifice or on cast iron burners (“C” burner), loosen air shutter & disconnect (unscrew) feedline from burner.



- Step 6. Remove main burner orifice from feed line. Inspect and clean if necessary.



- Step 7. Remove pilot assembly, refer to SERVICE PROCEDURE RG-III for cleaning and inspection.
- Step 8. Reassemble burner.
- Step 9. Inspect combustion chamber area of heater prior to reinstallation of burner assembly. If cleaning is required, refer to SERVICE PROCEDURE RG-VIII.
- Step 10. Reinstall burner assembly into combustion chamber, reconnect feedline, thermocouple and pilot tube to the combination thermostat/gas valve.
- Step 11. Reinstall inner door per SERVICE PROCEDURE RG-I, steps 4 through 13.
- Step 12. To resume operation, follow the instructions located on the lighting instruction label or the lighting instructions located in the installation and operation manual.

RESETTABLE THERMAL SWITCH CONTINUITY TESTING

- Step 1. Remove outer jacket door.
- Step 2. Disconnect wire leads from resettable thermal switch.



- Step 3. Using a multimeter capable of measuring continuity (Ohms), place one probe of meter on one of the brass connection tabs of the resettable thermal switch, and the remaining probe on the other connection tab.



- Step 4. If continuity is indicated, the switch is closed, allowing millivolt current to pass.
- Step 5. If continuity is not indicated, the switch is open, possibly due to an over heating condition. The switch is designed to open at predetermined temperatures depending on model. An open switch can be reset by depressing the red colored button located at the center of the switch. The overheating condition must be determined prior to putting the heater back in service.

PROBABLE CAUSE FOR RESETTABLE THERMAL SWITCH ACTIVATION	
PROBABLE CAUSE	CORRECTIVE ACTION
Insufficient combustion air	1. Verify adequate combustion air supply is available. 2. Clear jacket slot openings of any dirt, dust, restrictions or other obstructions. 3. inspect flame arrestor plate and clean with stiff brush and/or vacuum to remove scale deposits and debris.
1. Weak switch or switch out of calibration. 2. Incorrect switch.	1. Replace resettable thermal switch 2. Verify switch color code and approximate temperature.
Flammable vapor incident	1. Replace water heater.

Resettable thermal switch color code reference.	
Color Code	Approximate switch activation temperature (open)
Blue	240°
Yellow	270°
Red	290°

RESETTABLE THERMAL SWITCH REPLACEMENT

Step 1. Rotate knob of combination thermostat gas valve to the off position.

For Honeywell Control, rotate knob counter-clockwise to the "OFF" position.



For White Rodgers Control, depress knob slightly and rotate clockwise to the "OFF" position.



For Robertshaw Control, rotate knob clockwise to the "OFF" position.



Step 2. Remove outer jacket door.

Step 3. Disconnect wire leads from resettable thermal switch.

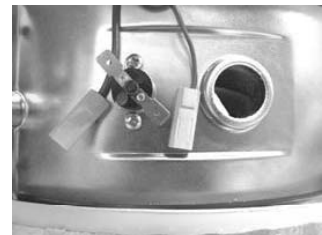

Step 4. Remove resettable thermal switch from inner door (Phillips screw driver)



Step 5. Place new resettable thermal switch in place. Be sure contact surface of resettable thermal switch and inner door are free of any debris. Secure resettable thermal switch into place using screws from step 4. **DO NOT OVER TIGHTEN SCREWS.**

Step 6. Reconnect wire leads from combination thermostat/gas valve to resettable thermal switch.

Note: Wire termination are interchangeable with either resettable thermal switch connection.

Step 7. Replace outer jacket door

Step 8. To resume operation follow the instructions located on the lighting instruction label or the lighting instruction located in the installation and operation manual.

ScreenLok® Flame Arrestor Cleaning

Step 1. Rotate knob of combination thermostat gas valve to the off position.

For Honeywell Control, rotate knob counter-clockwise to the "OFF" position.



For White Rodgers Control, depress knob slightly and rotate clockwise to the "OFF" position.



For Robertshaw Control, rotate knob clockwise to the "OFF" position.



Step 2. Remove outer jacket door.

Step 3. Remove inner door per SERVICE PROCEDURE RG-I, step 3a through 3e.

Step 4. Disconnect main burner feed line, pilot tube and thermocouple/thermopile from combination thermostat gas valve and remove burner assembly from combustion chamber.

NOTE: Feedline nut for natural gas control uses right hand threads, LP control uses left hand thread.

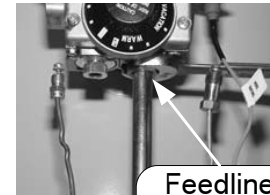

Feedline Nut

Step 5. Clean ScreenLok® Flame Arrestor using stiff brush, compressed air and/or shop vacuum to remove any scale or other debris accumulation. Using a soft brush, clear jacket openings of any dirt, dust, restrictions or other obstructions.

Step 6. Remove any debris from burner assembly per SERVICE PROCEDURE RG-V and reinstall burner assembly into combustion chamber.

Step 7. Reconnect feedline, thermocouple and pilot tube to the combination thermostat/gas valve.

Step 8. Reinstall inner door per SERVICE PROCEDURE RG-I, steps 4 through 13.

Step 9. To resume operation follow the instructions located on the lighting instruction label or the lighting instruction located in the installation and operation manual.

DIP TUBE INSPECTION AND REPLACEMENT

▲ WARNING
Heater components and stored water may be HOT when performing the following steps in this procedure. Take necessary precaution to prevent personal injury.

Step 1. Rotate knob of combination thermostat/gas valve to “OFF” position.

For Honeywell Control, rotate knob counter-clockwise to the “OFF” position.



For White Rodgers Control, depress knob slightly and rotate clockwise to the “OFF” position.



For Robertshaw Control, rotate knob clockwise to the “OFF” position.



Step 2. Turn off cold water supply to heater. Connect hose to drain spigot of water heater and route to an open drain. Open a nearby hot water faucet to vent heater for draining. Open drain spigot of hot water heater and allow heater to drain to a point below the inlet connection nipple.

Step 3. Disconnect inlet nipple from plumbing system.

Step 4. With an appropriate wrench, remove inlet nipple/dip tube from the water heater. Use caution not to damage pipe threads.

Step 5. Visually inspect inlet nipple/dip tube. Inlet nipple/dip tube should be free of cracks and any blockage. Hydro-jets located near the bottom of the dip tube should be open and free of any blockage. Anti-siphon hole located approximately 6" from the bottom of nipple, should be free of any blockage.

Any damage such as cracks, restriction due to deformation or unintentional holes are not field repairable and the inlet nipple/dip tube must be replaced.

Step 6. Upon completion of inspection or subsequent replacement, reinstall inlet nipple/dip tube into heater. Connect nipple to plumbing system, resume water supply and refill heater with water.

Step 7. To resume operation follow the instructions located on the lighting instruction label or the lighting instructions located in the installation and operation manual.

ANODE INSPECTION AND REPLACEMENT

⚠ WARNING
Heater components and stored water may be HOT when performing the following steps in this procedure. Take necessary precaution to prevent personal injury.

Step 1. Turn off water supply to water heater. Rotate knob of combination thermostat/gas valve to “OFF” position.

For Honeywell Control, rotate knob counter-clockwise to the “OFF” position.



For White Rodgers Control, depress knob slightly and rotate clockwise to the “OFF” position.



For Robertshaw Control, rotate knob clockwise to the “OFF” position.



Step 2. Turn off cold water supply to heater. Connect hose to drain spigot of water heater and route to an open drain. Open a nearby hot water faucet to vent heater for draining. Open drain spigot of hot water heater and allow heater to drain to a point below the outlet connection nipple.

Step 3. Disconnect outlet nipple from plumbing system.

Step 4. With an appropriate wrench, remove outlet nipple/anode from the water heater. Use caution not to damage pipe threads.

Step 5. Visually inspect outlet nipple/anode. Outlet nipple/anode should show signs of depletion, this is normal. If depletion is 1/2 of the original anode diameter (approximately 5/8” diameter), replacement is recommended. If any of the steel core of the anode is exposed, replacement is recommended.

Step 6. Upon completion of inspection or subsequent replacement, reinstall outlet nipple/anode into heater. Connect nipple to plumbing system, resume water supply and refill heater with water.

Step 7. To resume operation, follow the instructions located on the lighting instruction label or the lighting instructions located in the installation and operation manual.

Generic Parts List

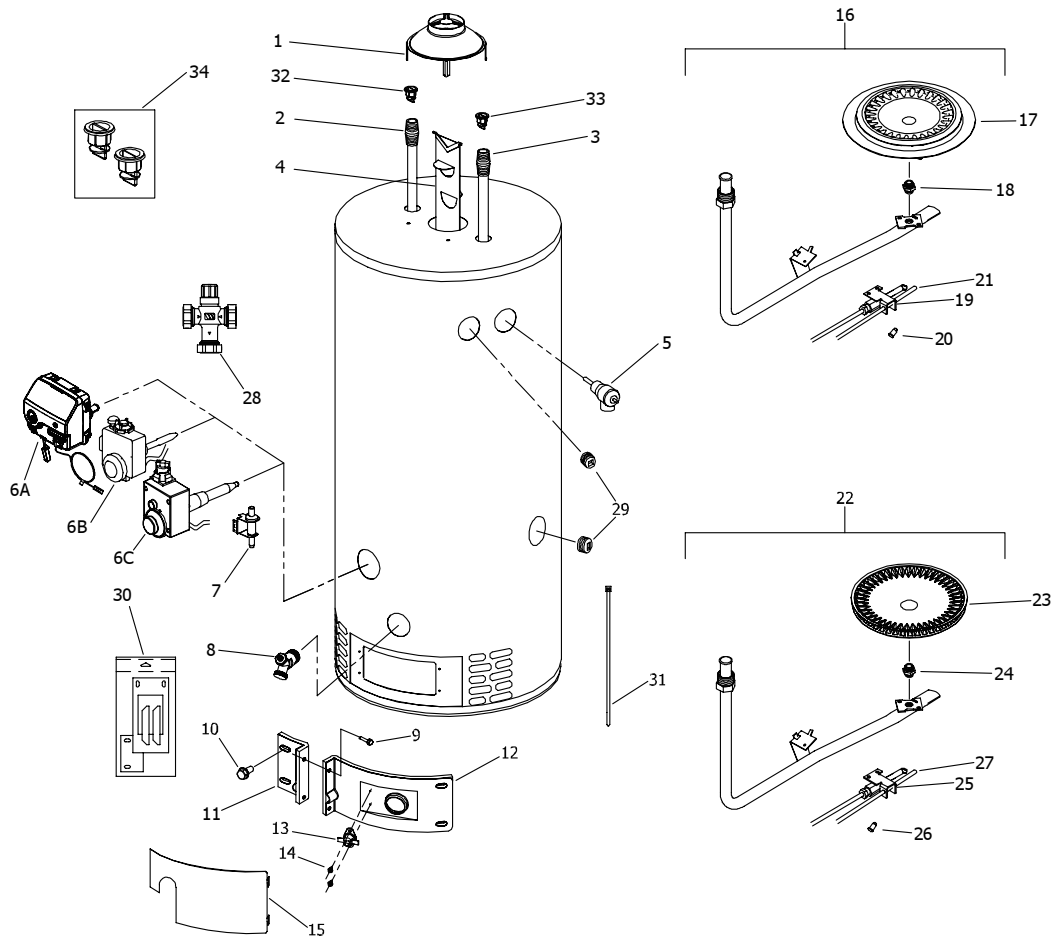

- | | | | |
|----|--|----|---------------------------------------|
| 1 | Draft Hood | 16 | Complete BN Burner Assembly (Natural) |
| 2 | Hot Water Outlet/Anode | 17 | BN Burner Only |
| 3 | Cold Water Inlet Tube | 18 | Main Burner Orifice |
| 4 | Flue Baffle | 19 | Pilot Assembly |
| 5 | T&P Relief Valve | 20 | Pilot Orifice |
| 6A | Gas Control (Honeywell) | 21 | Thermocouple/Thermopile |
| 6B | Gas Valve (Robertshaw) | 22 | Complete SX Burner Assembly (LP) |
| 6C | Gas Valve (White Rodgers) | 23 | SX Burner Only |
| 7 | Piezo Igniter (White Rodgers/Robertshaw) | 24 | Main Burner Orifice |
| 8 | Brass Drain Valve | 25 | Pilot Assembly |
| 9 | Screw-#8-18 x 3/4 Hex Washer Head | 26 | Pilot Orifice |
| 10 | Screw-#10-12 x 3/4 Hex Washer Head | 27 | Thermocouple/Thermopile |
| 11 | Left Side Inner Door with Gasket | 28 | ASSE Approved Mixing Valve (Optional) |
| 12 | Complete Right Side Inner Door | 29 | 3/4 NPT Tank Plug (XR Models) |
| 14 | Resettable Thermal Switch | 30 | Inner Door Gasket Kit |
| 15 | Outer Door | 31 | Wire Tie |
| | | 32 | Heat Trap (Outlet) |
| | | 33 | Heat Trap (Inlet) |
| | | 34 | Heat Trap Kit |



BRADFORD WHITE®

W A T E R H E A T E R S

Ambler, PA

For U.S. and Canada field service,
contact your professional installer or
local Bradford White sales representative.

Sales/800-523-2931
Fax/215-641-1670
Parts Fax/215-641-2180

Technical Support/800-334-3393
Fax/269-795-1089

Warranty/800-531-2111
Fax/269-795-1089

International:
Telephone/215-641-9400
Telefax/215-641-9750



BRADFORD WHITE-CANADA® INC.

Mississauga, ON

Sales/866-690-0961
905-238-0100

Fax/905-238-0105

Technical Support/800-334-3393

Email

parts@bradfordwhite.com
techserv@bradfordwhite.com

www.bradfordwhite.com